



ACVATIX™

## Control device PN40, safety function to DIN EN 14597

MK..6..

Preassembled valve-actuator combinations

- **MK..632..** Operating voltage AC 230 V, 3-position control signal
- **MK..662..** Operating voltage AC 24 V, control signal DC 0...10 V, 4...20 mA or 0...1000 Ω
- **MK..662..** Choice of flow characteristic, position feedback, stroke calibration, LED status indication, override control
- Electrohydraulic actuators
- With safety function to DIN EN 14597
- With position indicator
- Optional functions with auxiliary switches and potentiometer
- Cast steel GP240GH valve body
- DN 15...50
- $k_{vs}$  0.19...300 m<sup>3</sup>/h

### Use

---

Control devices with safety shut-off function per DIN EN 14597 for protection against excessive temperature and pressure in district heating, heating, ventilation and air conditioning systems.

For open and closed circuits (mind "Cavitation", refer to page 7).

## Type summary

| Control device               |  | MKB632..., MKC632..                     |  | MKB662..., MKC662..                          |  | 2-port valve              |                       |                    |                                 |       |     |       |                    |      |    |   |      |    |      |    |   |       |
|------------------------------|--|---|--|--|--|---------------------------|-----------------------|--------------------|---------------------------------|-------|-----|-------|--------------------|------|----|---|------|----|------|----|---|-------|
| Operating voltage            |  | Electrohydraulic actuator 2800 N, 120 s |  |  |  | $\Delta p_{max}$<br>[kPa] | $\Delta p_s$<br>[kPa] | DN                 | $k_{vs}$<br>[m <sup>3</sup> /h] | $S_v$ |     |       |                    |      |    |   |      |    |      |    |   |       |
| Positioning signal           |  | AC 230 V                                |  | AC 24 V                                      |  |                           |                       |                    |                                 |       |     |       |                    |      |    |   |      |    |      |    |   |       |
|                              |  | 3-position                              |  | DC 0...10 V, DC 4...20 mA, 0...1000 $\Omega$ |  |                           |                       |                    |                                 |       |     |       |                    |      |    |   |      |    |      |    |   |       |
| Product number               |  | Stock number                            |  | Product number                               |  | Stock number              |                       | 1600 <sup>1)</sup> | 3200                            | 15    | 3   | > 50  |                    |      |    |   |      |    |      |    |   |       |
| MKB632.15-0.19 <sup>2)</sup> |  | S55329-M180-A110                        |  | MKB662.15-0.19 <sup>2)</sup>                 |  | S55329-M180-A111          |                       |                    |                                 |       |     |       | 1600 <sup>1)</sup> | 3200 | 15 | 3 | > 50 |    |      |    |   |       |
| MKB632.15-0.3 <sup>2)</sup>  |  | S55329-M181-A110                        |  | MKB662.15-0.3 <sup>2)</sup>                  |  | S55329-M181-A111          |                       |                    |                                 |       |     |       |                    |      |    |   |      |    |      |    |   |       |
| MKB632.15-0.45 <sup>2)</sup> |  | S55329-M182-A110                        |  | MKB662.15-0.45 <sup>2)</sup>                 |  | S55329-M182-A111          |                       |                    |                                 |       |     |       |                    |      |    |   |      |    |      |    |   |       |
| MKB632.15-0.7 <sup>2)</sup>  |  | S55329-M183-A110                        |  | MKB662.15-0.7 <sup>2)</sup>                  |  | S55329-M183-A111          |                       |                    |                                 |       |     |       |                    |      |    |   |      |    |      |    |   |       |
| MKB632.15-1.2 <sup>2)</sup>  |  | S55329-M184-A110                        |  | MKB662.15-1.2 <sup>2)</sup>                  |  | S55329-M184-A111          |                       |                    |                                 |       |     |       |                    |      |    |   |      |    |      |    |   |       |
| MKB632.15-1.9 <sup>2)</sup>  |  | S55329-M185-A110                        |  | MKB662.15-1.9 <sup>2)</sup>                  |  | S55329-M185-A111          |                       |                    |                                 |       |     |       |                    |      |    |   |      |    |      |    |   |       |
| MKB632.15-3 <sup>2)</sup>    |  | S55329-M186-A110                        |  | MKB662.15-3 <sup>2)</sup>                    |  | S55329-M186-A111          |                       |                    |                                 |       |     |       |                    |      |    |   |      |    |      |    |   |       |
| MKB632.25-5 <sup>2)</sup>    |  | S55329-M187-A110                        |  | MKB662.25-5 <sup>2)</sup>                    |  | S55329-M187-A111          |                       |                    |                                 |       |     |       |                    |      |    |   |      |    |      |    |   |       |
| MKB632.25-7.5 <sup>2)</sup>  |  | S55329-M188-A110                        |  | MKB662.25-7.5 <sup>2)</sup>                  |  | S55329-M188-A111          |                       |                    |                                 |       |     |       |                    |      |    |   |      |    |      |    |   |       |
| MKB632.40-12 <sup>2)</sup>   |  | S55329-M189-A110                        |  | MKB662.40-12 <sup>2)</sup>                   |  | S55329-M189-A111          |                       |                    |                                 |       |     |       |                    |      |    |   |      |    |      |    |   |       |
| MKB632.40-19 <sup>2)</sup>   |  | S55329-M190-A110                        |  | MKB662.40-19 <sup>2)</sup>                   |  | S55329-M190-A111          |                       |                    |                                 |       |     |       |                    |      |    |   |      |    |      |    |   |       |
| MKB632.50-31 <sup>2)</sup>   |  | S55329-M191-A110                        |  | MKB662.50-31 <sup>2)</sup>                   |  | S55329-M191-A111          |                       |                    |                                 |       |     |       |                    |      |    |   |      |    |      |    |   |       |
| MKB632.25-5 <sup>2)</sup>    |  | S55329-M187-A110                        |  | MKB662.25-5 <sup>2)</sup>                    |  | S55329-M187-A111          |                       |                    |                                 |       |     |       |                    |      |    |   |      | 25 | 3200 | 15 | 3 | > 100 |
| MKB632.25-7.5 <sup>2)</sup>  |  | S55329-M188-A110                        |  | MKB662.25-7.5 <sup>2)</sup>                  |  | S55329-M188-A111          |                       |                    |                                 |       |     |       |                    |      |    |   |      |    |      |    |   |       |
| MKB632.40-12 <sup>2)</sup>   |  | S55329-M189-A110                        |  | MKB662.40-12 <sup>2)</sup>                   |  | S55329-M189-A111          |                       |                    |                                 |       |     |       |                    |      |    |   |      |    |      |    |   |       |
| MKB632.40-19 <sup>2)</sup>   |  | S55329-M190-A110                        |  | MKB662.40-19 <sup>2)</sup>                   |  | S55329-M190-A111          |                       |                    |                                 |       |     |       |                    |      |    |   |      |    |      |    |   |       |
| MKB632.50-31 <sup>2)</sup>   |  | S55329-M191-A110                        |  | MKB662.50-31 <sup>2)</sup>                   |  | S55329-M191-A111          |                       |                    |                                 |       |     |       |                    |      |    |   |      |    |      |    |   |       |
| MKB632.25-5 <sup>2)</sup>    |  | S55329-M187-A110                        |  | MKB662.25-5 <sup>2)</sup>                    |  | S55329-M187-A111          |                       | 40                 | 3200                            | 15    | 3   | > 50  |                    |      |    |   |      |    |      |    |   |       |
| MKB632.25-7.5 <sup>2)</sup>  |  | S55329-M188-A110                        |  | MKB662.25-7.5 <sup>2)</sup>                  |  | S55329-M188-A111          |                       |                    |                                 |       |     |       |                    |      |    |   |      |    |      |    |   |       |
| MKB632.40-12 <sup>2)</sup>   |  | S55329-M189-A110                        |  | MKB662.40-12 <sup>2)</sup>                   |  | S55329-M189-A111          |                       |                    |                                 |       |     |       |                    |      |    |   |      |    |      |    |   |       |
| MKB632.40-19 <sup>2)</sup>   |  | S55329-M190-A110                        |  | MKB662.40-19 <sup>2)</sup>                   |  | S55329-M190-A111          |                       |                    |                                 |       |     |       |                    |      |    |   |      |    |      |    |   |       |
| MKB632.50-31 <sup>2)</sup>   |  | S55329-M191-A110                        |  | MKB662.50-31 <sup>2)</sup>                   |  | S55329-M191-A111          |                       |                    |                                 |       |     |       |                    |      |    |   |      |    |      |    |   |       |
| MKB632.25-5 <sup>2)</sup>    |  | S55329-M187-A110                        |  | MKB662.25-5 <sup>2)</sup>                    |  | S55329-M187-A111          |                       | 50                 | 3200                            | 15    | 3   | > 100 |                    |      |    |   |      |    |      |    |   |       |
| MKB632.25-7.5 <sup>2)</sup>  |  | S55329-M188-A110                        |  | MKB662.25-7.5 <sup>2)</sup>                  |  | S55329-M188-A111          |                       |                    |                                 |       |     |       |                    |      |    |   |      |    |      |    |   |       |
| MKB632.40-12 <sup>2)</sup>   |  | S55329-M189-A110                        |  | MKB662.40-12 <sup>2)</sup>                   |  | S55329-M189-A111          |                       |                    |                                 |       |     |       |                    |      |    |   |      |    |      |    |   |       |
| MKB632.40-19 <sup>2)</sup>   |  | S55329-M190-A110                        |  | MKB662.40-19 <sup>2)</sup>                   |  | S55329-M190-A111          |                       |                    |                                 |       |     |       |                    |      |    |   |      |    |      |    |   |       |
| MKB632.50-31 <sup>2)</sup>   |  | S55329-M191-A110                        |  | MKB662.50-31 <sup>2)</sup>                   |  | S55329-M191-A111          |                       |                    |                                 |       |     |       |                    |      |    |   |      |    |      |    |   |       |
| MKB632.25-5 <sup>2)</sup>    |  | S55329-M187-A110                        |  | MKB662.25-5 <sup>2)</sup>                    |  | S55329-M187-A111          |                       | 1000 <sup>1)</sup> | 3200                            | 65    | 49  | > 100 |                    |      |    |   |      |    |      |    |   |       |
| MKB632.25-7.5 <sup>2)</sup>  |  | S55329-M188-A110                        |  | MKB662.25-7.5 <sup>2)</sup>                  |  | S55329-M188-A111          |                       |                    |                                 |       |     |       |                    |      |    |   |      |    |      |    |   |       |
| MKB632.25-10 <sup>2)</sup>   |  | S55329-M189-A110                        |  | MKB662.25-10 <sup>2)</sup>                   |  | S55329-M189-A111          |                       |                    |                                 |       |     |       |                    |      |    |   |      |    |      |    |   |       |
| MKB632.25-15 <sup>2)</sup>   |  | S55329-M190-A110                        |  | MKB662.25-15 <sup>2)</sup>                   |  | S55329-M190-A111          |                       |                    |                                 |       |     |       |                    |      |    |   |      |    |      |    |   |       |
| MKB632.25-20 <sup>2)</sup>   |  | S55329-M191-A110                        |  | MKB662.25-20 <sup>2)</sup>                   |  | S55329-M191-A111          |                       |                    |                                 |       |     |       |                    |      |    |   |      |    |      |    |   |       |
| MKB632.25-5 <sup>2)</sup>    |  | S55329-M187-A110                        |  | MKB662.25-5 <sup>2)</sup>                    |  | S55329-M187-A111          |                       | 700 <sup>1)</sup>  | 3200                            | 80    | 78  | > 100 |                    |      |    |   |      |    |      |    |   |       |
| MKB632.25-7.5 <sup>2)</sup>  |  | S55329-M188-A110                        |  | MKB662.25-7.5 <sup>2)</sup>                  |  | S55329-M188-A111          |                       |                    |                                 |       |     |       |                    |      |    |   |      |    |      |    |   |       |
| MKB632.25-10 <sup>2)</sup>   |  | S55329-M189-A110                        |  | MKB662.25-10 <sup>2)</sup>                   |  | S55329-M189-A111          |                       |                    |                                 |       |     |       |                    |      |    |   |      |    |      |    |   |       |
| MKB632.25-15 <sup>2)</sup>   |  | S55329-M190-A110                        |  | MKB662.25-15 <sup>2)</sup>                   |  | S55329-M190-A111          |                       |                    |                                 |       |     |       |                    |      |    |   |      |    |      |    |   |       |
| MKB632.25-20 <sup>2)</sup>   |  | S55329-M191-A110                        |  | MKB662.25-20 <sup>2)</sup>                   |  | S55329-M191-A111          |                       |                    |                                 |       |     |       |                    |      |    |   |      |    |      |    |   |       |
| MKB632.25-5 <sup>2)</sup>    |  | S55329-M187-A110                        |  | MKB662.25-5 <sup>2)</sup>                    |  | S55329-M187-A111          |                       | 450 <sup>1)</sup>  | 3200                            | 100   | 124 | > 100 |                    |      |    |   |      |    |      |    |   |       |
| MKB632.25-7.5 <sup>2)</sup>  |  | S55329-M188-A110                        |  | MKB662.25-7.5 <sup>2)</sup>                  |  | S55329-M188-A111          |                       |                    |                                 |       |     |       |                    |      |    |   |      |    |      |    |   |       |
| MKB632.25-10 <sup>2)</sup>   |  | S55329-M189-A110                        |  | MKB662.25-10 <sup>2)</sup>                   |  | S55329-M189-A111          |                       |                    |                                 |       |     |       |                    |      |    |   |      |    |      |    |   |       |
| MKB632.25-15 <sup>2)</sup>   |  | S55329-M190-A110                        |  | MKB662.25-15 <sup>2)</sup>                   |  | S55329-M190-A111          |                       |                    |                                 |       |     |       |                    |      |    |   |      |    |      |    |   |       |
| MKB632.25-20 <sup>2)</sup>   |  | S55329-M191-A110                        |  | MKB662.25-20 <sup>2)</sup>                   |  | S55329-M191-A111          |                       |                    |                                 |       |     |       |                    |      |    |   |      |    |      |    |   |       |
| MKB632.25-5 <sup>2)</sup>    |  | S55329-M187-A110                        |  | MKB662.25-5 <sup>2)</sup>                    |  | S55329-M187-A111          |                       | 300 <sup>1)</sup>  | 3200                            | 125   | 200 | > 100 |                    |      |    |   |      |    |      |    |   |       |
| MKB632.25-7.5 <sup>2)</sup>  |  | S55329-M188-A110                        |  | MKB662.25-7.5 <sup>2)</sup>                  |  | S55329-M188-A111          |                       |                    |                                 |       |     |       |                    |      |    |   |      |    |      |    |   |       |
| MKB632.25-10 <sup>2)</sup>   |  | S55329-M189-A110                        |  | MKB662.25-10 <sup>2)</sup>                   |  | S55329-M189-A111          |                       |                    |                                 |       |     |       |                    |      |    |   |      |    |      |    |   |       |
| MKB632.25-15 <sup>2)</sup>   |  | S55329-M190-A110                        |  | MKB662.25-15 <sup>2)</sup>                   |  | S55329-M190-A111          |                       |                    |                                 |       |     |       |                    |      |    |   |      |    |      |    |   |       |
| MKB632.25-20 <sup>2)</sup>   |  | S55329-M191-A110                        |  | MKB662.25-20 <sup>2)</sup>                   |  | S55329-M191-A111          |                       |                    |                                 |       |     |       |                    |      |    |   |      |    |      |    |   |       |
| MKB632.25-5 <sup>2)</sup>    |  | S55329-M187-A110                        |  | MKB662.25-5 <sup>2)</sup>                    |  | S55329-M187-A111          |                       | 200 <sup>1)</sup>  | 3200                            | 150   | 300 | > 100 |                    |      |    |   |      |    |      |    |   |       |
| MKB632.25-7.5 <sup>2)</sup>  |  | S55329-M188-A110                        |  | MKB662.25-7.5 <sup>2)</sup>                  |  | S55329-M188-A111          |                       |                    |                                 |       |     |       |                    |      |    |   |      |    |      |    |   |       |
| MKB632.25-10 <sup>2)</sup>   |  | S55329-M189-A110                        |  | MKB662.25-10 <sup>2)</sup>                   |  | S55329-M189-A111          |                       |                    |                                 |       |     |       |                    |      |    |   |      |    |      |    |   |       |
| MKB632.25-15 <sup>2)</sup>   |  | S55329-M190-A110                        |  | MKB662.25-15 <sup>2)</sup>                   |  | S55329-M190-A111          |                       |                    |                                 |       |     |       |                    |      |    |   |      |    |      |    |   |       |
| MKB632.25-20 <sup>2)</sup>   |  | S55329-M191-A110                        |  | MKB662.25-20 <sup>2)</sup>                   |  | S55329-M191-A111          |                       |                    |                                 |       |     |       |                    |      |    |   |      |    |      |    |   |       |

<sup>1)</sup> Permissible working pressure and medium temperature for steam refer to diagram page 7 and 10

<sup>2)</sup> While stocks last

DN = Nominal size

$k_{vs}$  = Nominal flow rate of cold water (5...30 °C) through the fully open valve ( $H_{100}$ ) by a differential pressure of 100 kPa (1 bar)

$S_v$  = Rangeability  $k_v/k_{vr}$

$k_{vr}$  = Smallest  $k_v$  value, at which the flow characteristic tolerances can still be maintained, by a differential pressure of 100 kPa (1 bar)

## Accessories

| Product number | Description                 | For control devices  | Mounting location |
|----------------|-----------------------------|----------------------|-------------------|
| ASC1.6         | Auxiliary switch            | MKB662..., MKC662..  | 1 x ASC 1.6       |
| ASC9.3         | Dual auxiliary switches     | MKB632..<br>MKC632.. | 1 x ASC9.3 or     |
| ASZ7.3         | Potentiometer 1000 $\Omega$ |                      | 1 x ASZ7.3 or     |
| ASZ7.31        | Potentiometer 135 $\Omega$  |                      | 1 x ASZ7.31 or    |
| ASZ7.32        | Potentiometer 200 $\Omega$  |                      | 1 x ASZ7.32       |

## Ordering

| Product number | Stock number     | Designation  |
|----------------|------------------|--|
| MKC632.80-78   | S55329-M193-A120 | Control device PN25, safety function to DIN EN 14597 |

## Delivery

Prior delivery valve and actuator are preassembled. The control device is preset to 50 % stroke. Accessories are packed and supplied separately

## Spare parts

No spare parts available. The control device has to be replaced as a whole unit else TÜV approval for the safety function to DIN EN 14597 ceases.

## Technical design

The functional principle and technical details are described in valve and actuator data sheets:

| Product                    | Type    | Data sheet |
|----------------------------|---------|------------|
| Electrohydraulic actuators | SKB..   | N4564      |
| Electrohydraulic actuators | SKC..   | N4566      |
| 2-port valves              | VVF61.. | N4382      |

Direction of flow

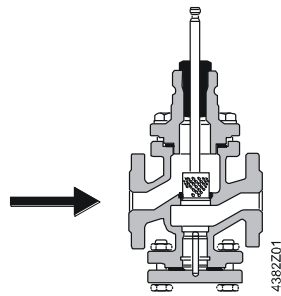

DN 15/ 25: closes against pressure

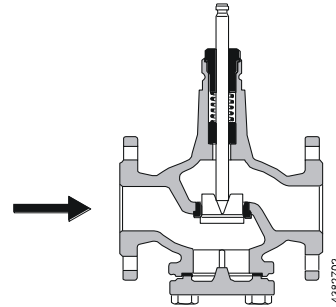

DN 40...150: closes on pressure

### Spring return facility

The return spring causes the actuator to move to the «0 %» stroke position and closes the valve.

**MK..632..**  
3-position

- Voltage on Y1 piston extends valve opens
- Voltage on Y2 piston retracts valve closes
- No voltage on Y1 and Y2 piston / valve stem remain in the respective position

**MK..662..**  
DC 0...10 V,  
DC 4... 20 mA, 0...1000 Ω

- Signal Y increasing: piston extends valve opens
- Signal Y decreasing: piston retracts valve closes
- Signal Y constant: piston / valve stem remain in the respective position
- Override control Z see description of override control input, page 5

Frost protection  
thermostat

A frost protection thermostat or temperature detector can be connected to the MKD662.. control device.

The added signals from the QAF21.. and QAF61.. cannot be connected.



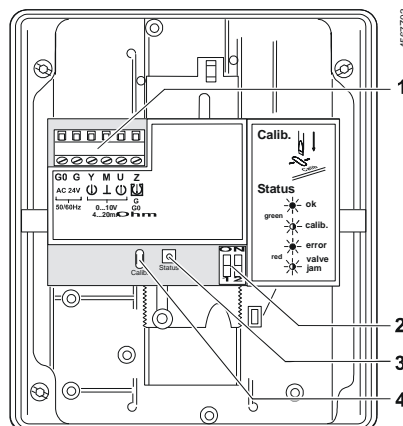

«Connection diagrams» for operation with frost protection thermostat or frost protection monitor refer to page 15.

**Standard electronics**  
MK..662..



- 1 Connection terminals
- 2 Mode DIL switches
- 3 LED status indication
- 4 Slot for calibration

**DIL switches**  
MK..662..

|        | Positioning signal Y<br>Position feedback U  | Flow characteristic  |
|--------|--|--|
| ON     |  DC 4...20 mA |  lin = linear           |
| OFF *) |  DC 0...10 V  |  log = equal-percentage |

\*) Factory setting: All switches OFF

Relationship between control signal Y and volumetric flow

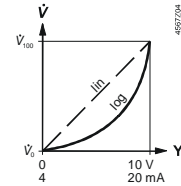

## Stroke calibration MK..662..

In order to determine the stroke positions 0 % and 100 % in the valve, calibration is required on initial commissioning:

### Prerequisites

- AC 24 V power supply
- Red safety clamp has to be removed, see commissioning notes .
- Housing cover removed

### Calibration

1. Short-circuit contacts in calibration slot (e.g. with a screwdriver)
2. Actuator moves to «0 %» stroke position (1) (valve closed)
3. Actuator moves to «100 %» stroke position (2) (valve open)
4. Measured values are stored

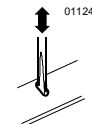

green LED flashes;  
position feedback U inactive

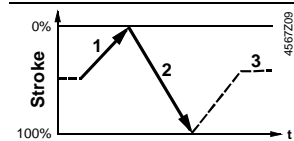





### Normal operation

- |  |  |
|--|--|
| 5. Actuator moves to the position (3) as indicated by signals Y or Z | green LED is lit permanently;<br>position feedback U active, the values correspond to the actual positions |
|--|--|

A lit red LED indicates a calibration error.  
The calibration can be repeated any number of times.

## Indication of operating state MK..662..

The LED status indication indicates operational status and is visible with removed cover.

| LED   | Indication   | Function                              | Remarks, troubleshooting  |
|-------|--|---------------------------------------|---|
| Green | Lit       | Normal operation                      | Automatic operation; everything o.k.  |
|       | Flashing  | Calibration in progress               | Wait until calibration is finished (LED stops flashing, green or red LED will be lit) |
| Red   | Lit       | Faulty stroke calibration             | Check mounting<br>Restart stroke calibration (by short-circuiting calibration slot)   |
|       | Flashing  | Internal error<br>Inner valve jammed  | Replace electronics<br>Check valve  |
| Both  | Dark      | No power supply<br>Electronics faulty | Check mains network, check wiring<br>Replace electronics                              |

As a general rule, the LED can assume only the states shown above (continuously red or green, flashing red or green, or off).

**Override control input Z**  
MK..662..

Override control input can be operated in following different modes of operation

|                    |                 | <b>Z-mode</b>   |  |   |   |
|--------------------|-----------------|---|--|---|---|
|                    |                 | no function   | fully open   | closed  | override with 0...1000 Ω  |
| <b>Connections</b> |                 |   |  |   |   |
|                    | <b>Transfer</b> |   |  |   |   |
|                    |                 | linear or equal-percentage  |  |   | linear or equal-percentage  |
|                    |                 | <ul style="list-style-type: none"> <li>• Z-contact not connected</li> <li>• Valve stroke follows Y-input</li> </ul> | <ul style="list-style-type: none"> <li>• Z-contact connected directly to G</li> <li>• Y-input has no effect</li> </ul> | <ul style="list-style-type: none"> <li>• Z-contact connected directly to G0</li> <li>• Y-input has no effect</li> </ul> | <ul style="list-style-type: none"> <li>• Z-contact connected to M via resistor R</li> <li>• Starting position at 50 Ω / end position at 900 Ω</li> <li>• Y-input has no effect</li> </ul> |

Note Shown operation modes are based on the factory setting «direct acting»  
Y-input has no effect in Z-mode.

**Accessories**

MK..632..

**ASC9.3**  
double auxiliary switch

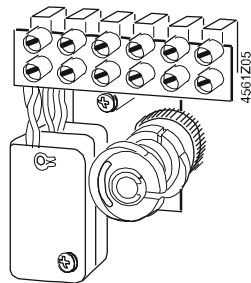

adjustable switching points

**ASZ7.3..**  
potentiometer

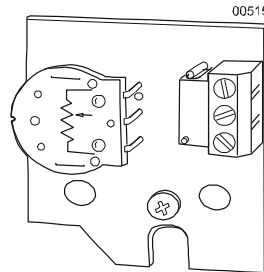

ASZ7.3: 0...1000 Ω  
ASZ7.31: 0...135 Ω  
ASZ7.32: 0...200 Ω

MK..662..

**ASC1.6**  
Auxiliary switch

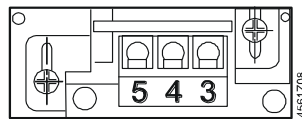

Switching point 0...5 % stroke

Flow diagram

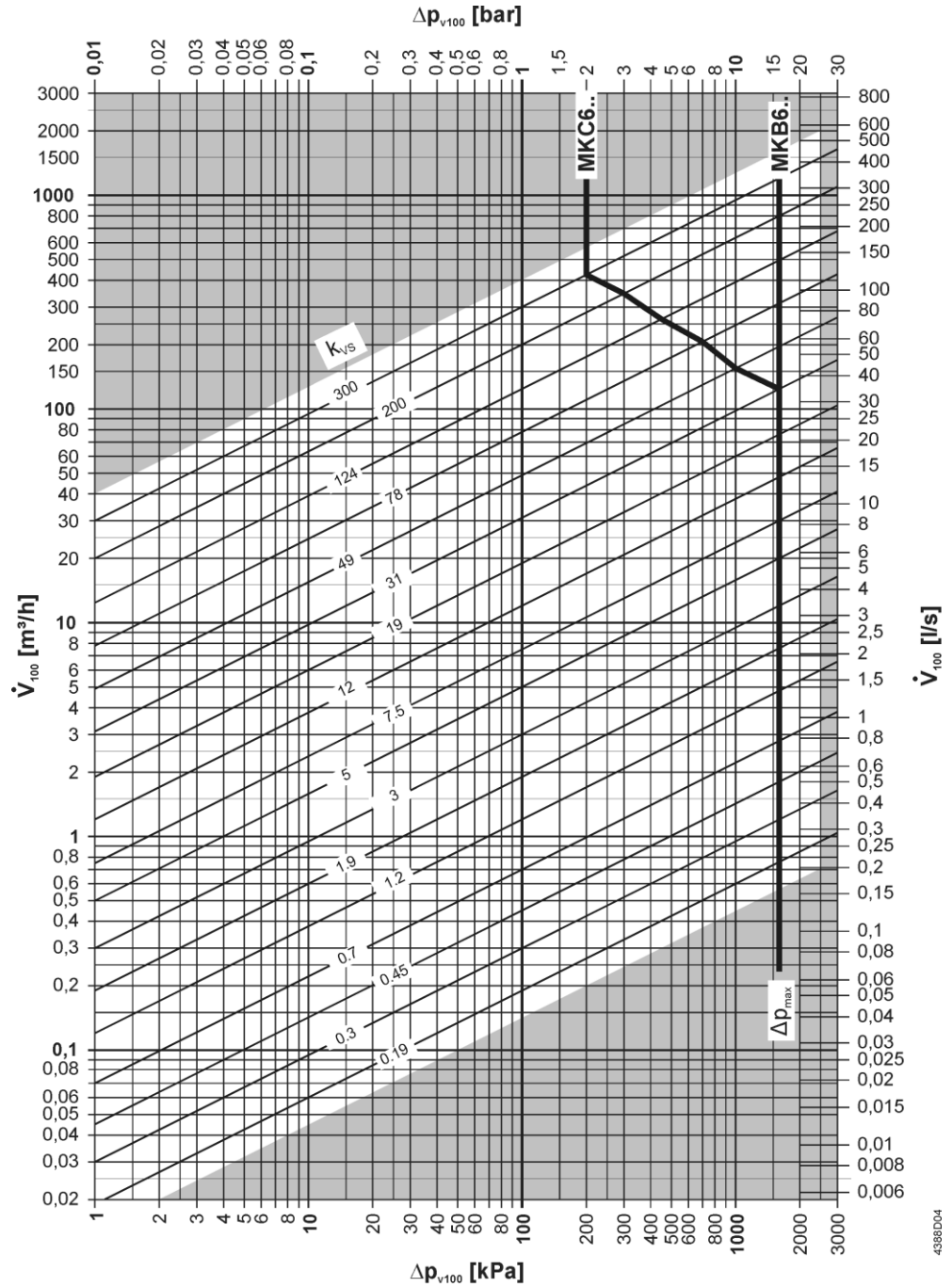

- $\Delta p_{max}$  = Maximum permissible differential pressure across the valve, valid for the entire actuating range of the motorized valve
- $\Delta p_{v100}$  = Differential pressure across the fully open valve and the valve's control path by a volume flow  $V_{100}$
- $\dot{V}_{100}$  = Volume flow through the fully open valve ( $H_{100}$ )
- 100 kPa = 1 bar  $\approx$  10 mWC
- 1  $m^3/h$  = 0.278 l/s water at 20 °C

Valve flow characteristic

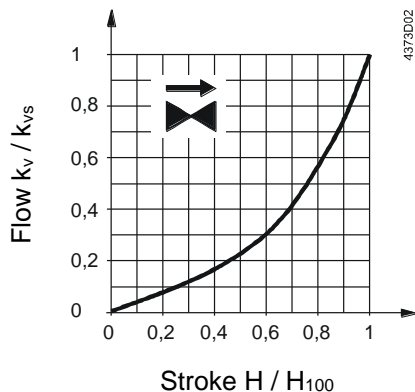

0...30 % → linear  
 30...100 % → equal percentage  
 $n_{gl} = 3$  as per  
 VDI / VDE 2173

**Cavitation**

Cavitation accelerates wear on the valve plug and seat, and also results in undesirable noise. Cavitation can be avoided by not exceeding the differential pressure shown in the flow diagram on page 5 and by adhering to the static pressures shown below.

**Note on chilled water**

To avoid cavitation in chilled water circuits ensure sufficient counter pressure at valve outlet, e.g. by a throttling valve after the heat exchanger. Select the pressure drop across the valve at maximum according to the 80 °C curve in the flow diagram below.

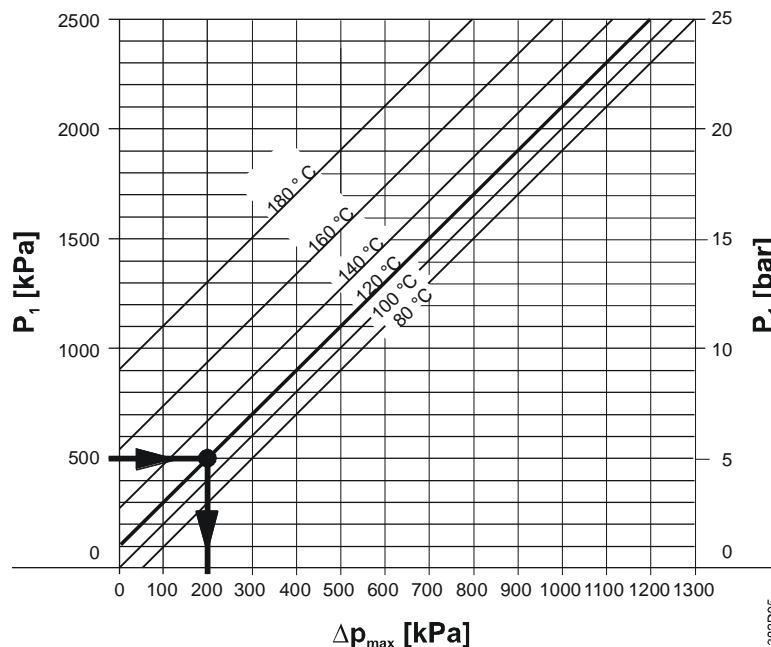

- $\Delta p_{max}$  = Differential pressure with valve almost closed, at which cavitation can largely be avoided
- $p_1$  = Static pressure at inlet
- $p_3$  = Static pressure at outlet
- M = Pump
- $\vartheta$  = Water temperature

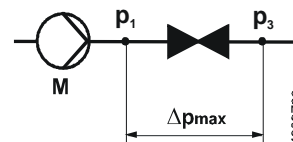

High temperature hot water example:

Pressure  $p_1$  at valve inlet: 500 kPa (5 bar)  
 Water temperature: 120 °C

From the diagram above, it will be seen that with the valve almost closed, the maximum permissible differential pressure  $\Delta p_{max}$  is 200 kPa (2 bar).

Chilled water example:

Spring water cooling as an example of avoiding cavitation:

- Chilled water = 12 °C
- $p_1$  = 500 kPa (5 bar)
- $p_4$  = 100 kPa (1 bar) (atmospheric pressure)
- $\Delta p_{max}$  = 300 kPa (3 bar)
- $\Delta p_{3-3'}$  = 20 kPa (0.2 bar)
- $\Delta p_D$  (throttle) = 80 kPa (0.8 bar)
- $p_{3'}$  = pressure after consumer in kPa

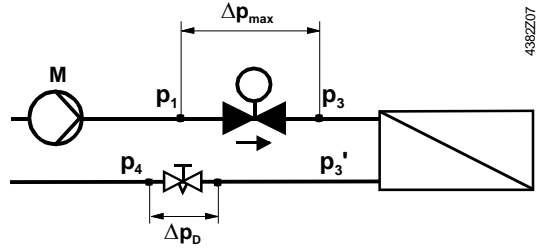

4382D07

**Working pressure and medium temperature**  
Fluids

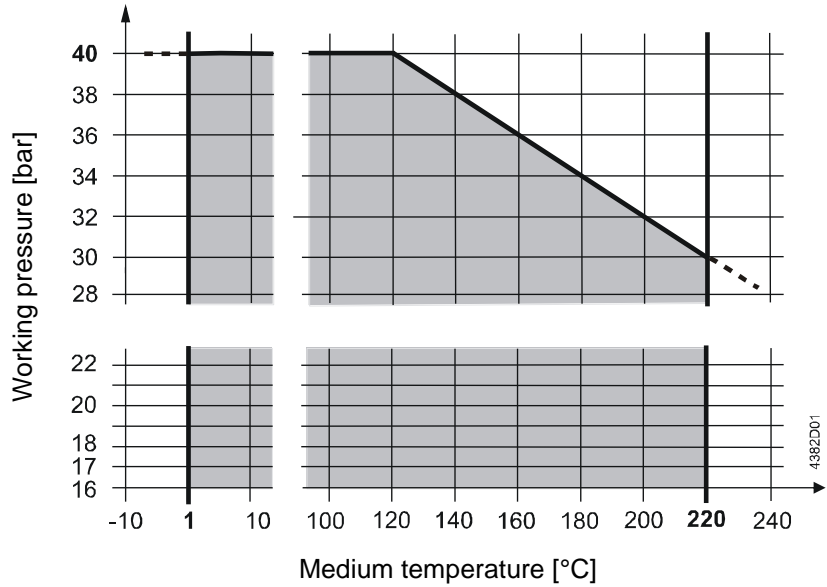

4382D01

**Working pressure and medium temperature staged as per DIN 4747-1**



Current local legislation must be observed.

**Working pressure and medium temperature**  
Saturated steam  
Superheated steam

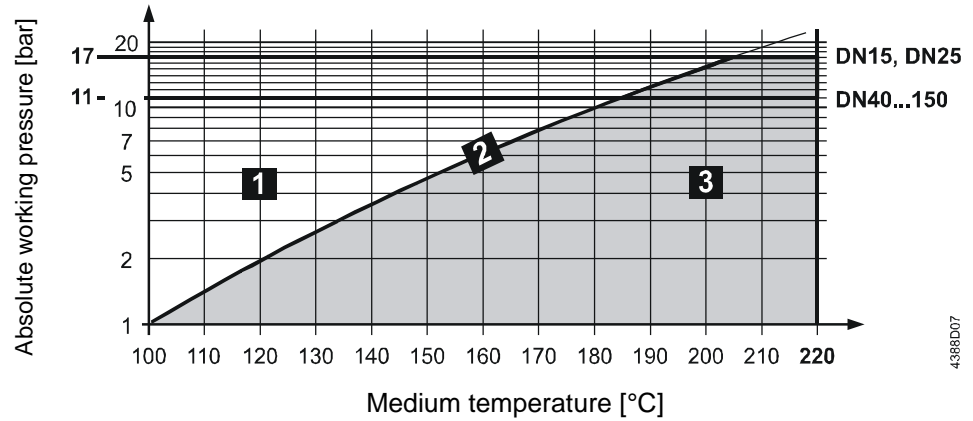

4388D07

|          |                   |                          |
|----------|-------------------|--------------------------|
| <b>1</b> | wet steam         | avoid                    |
| <b>2</b> | saturated steam   | permissible range of use |
| <b>3</b> | superheated steam |                          |

Recommendation

For saturated steam and superheated steam the differential pressure  $\Delta p_{max}$  across the valve should be close to the critical pressure ratio.

$$\text{Pressure ratio} = \frac{p_1 - p_3}{p_1} \cdot 100\%$$

- $p_1$  = absolute pressure before valve in kPa
- $p_3$  = absolute pressure after valve in kPa



**Calculation of the  $k_{vs}$  value for steam**

**Subcritical range**

$$\frac{p_1 - p_3}{p_1} \cdot 100\% < 42\%$$

Pressure ratio < 42% subcritical

$$k_{vs} = 4.4 \cdot \frac{\dot{m}}{\sqrt{p_3 \cdot (p_1 - p_3)}} \cdot k$$

**Supercritical range**

$$\frac{p_1 - p_3}{P_1} \cdot 100\% \geq 42\%$$

Pressure ratio  $\geq$  42% supercritical (not recommended)

$$k_{vs} = 8.8 \cdot \frac{\dot{m}}{p_1} \cdot k$$

$\dot{m}$  = steam quantity in kg/h

$k$  = factor for superheating of steam =  $1 + 0.0012 \cdot \Delta T$  ( $k = 1$  for saturated steam)

$\Delta T$  = temperature differential in K between saturated steam and superheated steam

**Example**

given saturated steam 151.8 °C  
 $p_1$  = 500 kPa (5 bar)  
 $\dot{m}$  = 460 kg/h  
 pressure ratio = 30 %

saturated steam 151.8 °C  
 $p_1$  = 500 kPa (5 bar)  
 $\dot{m}$  = 460 kg/h  
 pressure ratio = 42 %  
 (supercritical permitted)

required  $k_{vs}$ , valve type

$k_{vs}$ , valve type

procedure

$$p_3 = p_1 - \frac{30 \cdot p_1}{100}$$

$$p_3 = 500 - \frac{30 \cdot 500}{100} = 350 \text{ kPa (3.5bar)}$$

$$k_{vs} = 4.4 \cdot \frac{460}{\sqrt{350 \cdot (500 - 350)}} \cdot 1 = 8.83 \text{ m}^3/\text{h}$$

$$k_{vs} = 8.8 \cdot \frac{460}{500} \cdot 1 = 8.09 \text{ m}^3/\text{h}$$

selected  $k_{vs} = 10 \text{ m}^3/\text{h} \Rightarrow$  MKB632.40-12

$k_{vs} = 8 \text{ m}^3/\text{h} \Rightarrow$  MKB632.25-7.5

**Engineering notes**

We recommend installation in the return pipe, as the temperatures in this pipe are lower for applications in heating systems, which in turn, extends the stem sealing gland's life.



In open circuits the valve plug may seize as the result of scale deposits. We recommend that the valve should be exercised at regular intervals (two to three times per week).

A strainer **MUST** be fitted at the valve inlet

Ensure cavitation free flow (refer to page 7).



To ensure the reliability of the valve, we recommend the fitting of a strainer at the valve inlet even in closed circuits.

The use of these valves for steam is subject to specific parameters: Observe diagram for steam on page 8 and "Technical data" on page 12!

Conduct the electrical connections in accordance with local regulations on electrical installations as well as the internal or connection diagrams.



**Safety regulations and restrictions designed to ensure the safety of people and property must be observed at all times!**

If an auxiliary switch is required, its switching point should be indicated on the plant schematic.

Every actuator must be driven by a dedicated controller (refer to «Connection diagrams», page 15).

## Mounting notes

Valve and actuator are preassembled and must be mounted and installed as a whole unit.

The control device is preset to 50 % stroke for flushing and pressure testing of the plant.



**Attention:** When removing anti-tamper screws TÜV approval for the safety function to DIN EN 14597 ceases!

Mounting and installation instructions are by packed in the control device packing.

| Control device | Installation instruction |              | Mounting instructions |               |
|----------------|--------------------------|--------------|-----------------------|---------------|
| MK..6..        | -                        | -            | M3240                 | 4 319 0324 0  |
|                | -                        | -            | M4300                 | 74 319 0509 0 |
| MK..662..      | -                        | 4 319 0326 0 | M3240                 | 4 319 0324 0  |
|                | -                        | -            | M4300                 | 74 319 0509 0 |

The instructions for accessories are enclosed with the accessories themselves.

| Accessories | Installation instructions |              | Accessories | Mounting instructions |
|-------------|---------------------------|--------------|-------------|-----------------------|
| ASC1.6      | G4563.3                   | 4 319 5544 0 | ASZ7.3..    | -                     |
| ASC9.3      | G4561.3                   | 4 319 5545 0 |             | 74 319 0247 0         |

orientation

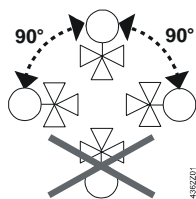

Direction of flow

When mounting, pay attention to the valve's flow direction symbol →.

MK..6.. → Direction of action: closes against pressure

## Commissioning notes



**The manual adjuster must remain secured with anti-tamper screws as factory delivered. When removing anti-tamper screws TÜV approval for the safety function to DIN EN 14597 ceases.**

Valve stem retracts: valve opens = increasing flow

Valve stem extends: valve closes = decreasing flow

When commissioning the system, check the wiring and functions, and set any auxiliary switches and potentiometers as necessary, or check the existing settings.

The actuator is driven to OPEN (valve open) until the red clamp, that fixes a stroke position of ca. 50 % can be easily removed. Voltage must be applied to either terminal 21 and Y1 to drive to OPEN, or voltage to G-G0 as well as Y > 70 %.



**The safety function is only enabled after the red safety clamp is removed.**

MKB..

Cylinder with valve stem connector fully retracted  
→ stroke = 0%

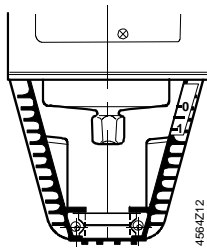

Cylinder with valve stem connector fully extended  
→ stroke = 100 %

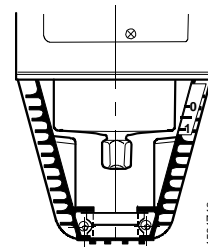

## Automatic operation

The control device can only be operated in automatic mode. The crank (2) on the manual adjustment knob (1) is engaged and secured with anti-tamper screws.

When removing anti-tamper screws (3) TÜV approval for the safety function to DIN EN 14597 ceases.

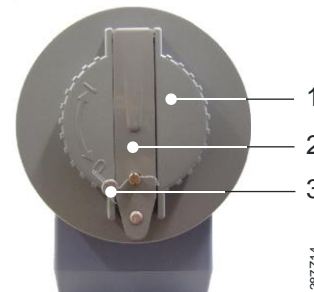

Engaged crank (2) on the manual adjustment knob (1)

## Maintenance notes



The MK..6.. control devices are maintenance-free

When servicing the control device:

- **Never disassemble valve and actuator for maintenance or servicing else TÜV approval for the safety function to DIN EN 14597 ceases.**
- **Switch off pump of the hydronic loop**
- **Interrupt the power supply to the actuator**
- **Close the main shutoff valves in the system**
- **Release pressure in the pipes and allow them to cool down completely**
- **If necessary, disconnect electrical connections from the terminals**

Recommendation MK..662..: Trigger stroke calibration after servicing or maintenance.

Repair

The control device has to be replaced as a whole unit else TÜV approval for the safety function to DIN EN 14597 ceases.

### Warning

**A damaged housing or cover represents an injury risk.**

- **NEVER** uninstall an actuator from the valve.
- **Uninstall the valve-actuator combination (actuating device) as a complete device.**
- **Use only properly trained technicians to uninstall the unit.**
- **Send the actuating device together with an error report to your local Siemens representative for analysis and disposal.**
- **Properly mount the new actuating device (valve and actuator).**

Parts could fly ultimately resulting in injuries from uninstalling an actuator with a damaged valve housing due to the tensioned return spring.

Sealing gland

It is not permitted to replace the sealing glands. In case of leakages, the control device has to be replaced as a whole unit else TÜV approval for the safety function to DIN EN 14597 ceases.

## Disposal



The device contains electrical and electronic components and must not be disposed of together with domestic waste. This applies in particular to the PCB.

Before disposal the valve must be dismantled and separated into its various constituent materials.

Legislation may demand special handling of certain components, or it may be sensible from an ecological point of view.

**Current local legislation must be observed.**

## Warranty

The technical data relating to specific applications are valid only in conjunction with the control devices listed in this data sheet under «Type summary», page 2.



**Approval as actuating device with safety function as per DIN EN 14597 applies to the entire actuator. Approval as actuating device with safety function as per DIN EN 14597 expires if the actuator is separated from the valve. This also voids any guarantees on the part of Siemens Switzerland Ltd.**

## Technical data

|                    |                     | MKB632..   | MKC632..               | MKB662.. | MKC662..      |
|--------------------|---------------------|--|------------------------|----------|---------------|
| <b>Valve</b>       | PN class            | PN 40 to ISO 7268  |                        |          |               |
|                    | Working pressure    | to ISO 7005 within the permissible "working pressure and medium temperature" according to the diagram on page 8  |                        |          |               |
|                    | Flow characteristic | linear   |                        |          |               |
|                    | 0...30 %            | equal percentage; $n_{gl} = 3$ to VDI / VDE 2173   |                        |          |               |
|                    | 30...100 %          |  |                        |          |               |
|                    | Leakage rate        | 0...0.05 % of $k_{vs}$ value to DIN EN 1349  |                        |          |               |
|                    | Permissible media:  |  |                        |          |               |
|                    | Water               | cooling water, chilled water, low temperature hot water, high temperature hot water, water with anti-freeze; recommendation: water treatment to VDI 2035 |                        |          |               |
|                    | Brine               |  |                        |          |               |
|                    | Steam               | saturated steam, super-heated steam; dryness at inlet minimum 0.98   |                        |          |               |
| Heat transfer oils |                     |  |                        |          |               |
| Medium temperature |                     |  |                        |          |               |
| Water, brine       | +1...220 °C         |  |                        |          |               |
| steam              | DN15...25           | $\leq 220$ °C, $\leq 1700$ kPa (17 bar) abs  |                        |          |               |
|                    | DN 40...150         | $\leq 220$ °C, $\leq 1100$ kPa (11 bar) abs  |                        |          |               |
|                    |                     | Permissible working pressure and medium temperature refer to diagram page 7 and 10   |                        |          |               |
| Heat transfer oils | $\leq 220$ °C       |  |                        |          |               |
| Rangeability $S_v$ | DN 15...40:         | > 50   | (MK..6..25-7.5: > 100) |          |               |
|                    | DN 50...150:        | > 100  |                        |          |               |
| <b>Materials</b>   | Valve body          | cast steel GP240GH   |                        |          |               |
|                    | Stem                | Stainless steel  |                        |          |               |
|                    | Plug, seat          | Stainless steel  |                        |          |               |
|                    | Sealing gland       | Stainless steel  |                        |          |               |
|                    | Gland materials     | PTFE sleeve  |                        |          |               |
| <b>Actuators</b>   |                     |  |                        |          |               |
|                    | Power supply        | Operating voltage  | AC 230 V               |          | AC 24 V       |
|                    |                     | Voltage tolerance  | $\pm 15$ %             |          | -20 % / +30 % |
|                    |                     |  |                        |          | SELV / PELV   |
| Frequency          | 50 or 60 Hz         |  |                        |          |               |

|                 |  | MKB632..  | MKC632..     | MKB662..   | MKC662.. |      |
|-----------------|--|---|--------------|--|----------|------|
|                 | Max. Power consumption at 50 Hz                      | MKB632..: 15 VA / 13 W<br>MKC632..: 24 VA / 21 W  |              | MKB662..: 17 VA / 12 W<br>MKC662..: 24 VA / 18 W   |          |      |
|                 | External supply cable fuse                           | min. 0.5 A, slow<br>max. 6 A, slow  |              | MKB662..: min. 1 A, slow<br>max. 10 A, slow<br>MKC662..: min. 1,6 A, slow<br>max. 10 A, slow                   |          |      |
| Signal inputs   | Control signal Y                                     | 3-position  |              | DC 0...10 V, DC 4...20 mA<br>or 0...1000 Ω   |          |      |
| Signal inputs   | Terminal Y   | Voltage<br>Input impedance<br>Current<br>Input impedance<br>Signal resolution<br>Hysteresis   |              | DC 0...10 V<br>100 kΩ<br>DC 4...20 mA<br>240 Ω<br>< 1%<br>1 %  |          |      |
|                 | Override control Z                                   | Resistor<br>Z not connected<br><br>Z connected directly to G<br>Z connected directly to G0<br>Z connected to M via 0...1000 Ω   |              | 1000 Ω<br>No function, priority terminal Y<br>max. stroke 100 %<br>min. stroke 0 %<br>stroke proportional to R |          |      |
| Signal outputs  | Position feedback U                                  | voltage<br>load impedance<br>current<br>load impedance  |              | DC 0...9.8 V ±2 %<br>> 10 kΩ<br>DC 4...19.6 mA ±2 %<br>< 500 Ω   |          |      |
| Operating data  | Positioning time at 50 Hz                            | opening   | 120 s        |  | 120 s    |      |
|                 |  | closing   | 120 s        |  | 10 s     | 20 s |
|                 | Spring-return time (closing)                         | 5...25 s  |              |  |          |      |
|                 | Nominal stroke                                       | 20 mm   | 40 mm        | 20 mm  | 40 mm    |      |
|                 | Max. permissible medium temperature                  | +1...220 °C   |              |  |          |      |
| EI. Connections | Cable entry  | 4 x M20 (Ø 20.5 mm)   |              |  |          |      |
| Materials       | Actuator housing, bracket                            | Die-cast aluminum   |              |  |          |      |
|                 | Housing box and manual adjuster                      | Plastic   |              |  |          |      |
| Dimensions      | Dimensions   | Refer to "Dimensions", page 16  |              |  |          |      |
|                 | Weights  | Refer to "Dimensions", page 16  |              |  |          |      |
| Norms           | CE-conformity<br>EMC-directive                       | 2004/108/EC   |              |  |          |      |
|                 |  | Immunity  | EN 61000-6-2 | Industrial   |          |      |
|                 | Emission   | EN 61000-6-3  | Residential  |  |          |      |
|                 | Low voltage directive                                | 2006/95/EC  |              |  |          |      |
|                 |  | Electrical safety   | EN 60730-1   |  |          |      |
|                 | Product standards for automatic electric controls    | EN 60730-2-14   |              |  |          |      |
|                 | Control device with safety function                  | DIN EN 14597<br>Temperature control devices and temperature limiters for heat generating systems; Actuator devices with safety functions in heat generating systems<br>MKB.. Registration no.: 1F137/10<br>MKC.. Registration no.: 1F138/10 |              |  |          |      |
|                 | Protection standard EN 60730                         | I   |              | III  |          |      |
|                 | Housing protection standard<br>Upright to horizontal | IP54 to EN 60529  |              |  |          |      |
|                 | Conform with C-tick                                  |   |              |  | N474     |      |

|                                   | MKB632..  | MKC632..                       | MKB662..   | MKC662..                               |
|-----------------------------------|---|--------------------------------|------------|--|
| Environmental compatibility       | ISO 14001 (Environment)<br>ISO 9001 (Quality)<br>SN 36350 (Environmentally compatible products)<br>RL 2002/95/EG (RoHS) |                                |            |  |
| Pressure Equipment Directive      | PED 97/23/EC  |                                |            |  |
| Accessories with safety functions | As per article 3, section 1.4   |                                |            |  |
| Fluid group 2                     | Category IV, with EC design examination module B,<br>test authority number 0036   |                                |            |  |
| Flange connections                | to ISO 7005   |                                |            |  |
| <b>Accessories</b>                |   |                                |            |  |
| ASC1.6<br>Auxiliary switch        | Switching capacity  |                                |            | AC 24 V,<br>10 mA...4 A ohm., 2 A ind. |
| ASC9.3<br>double auxiliary switch | Switching capacity per auxiliary switch   | AC 250 V, 6 A ohm., 2.5 A ind. |            |  |
| ASZ7.3<br>Potentiometer           | Change in overall resistance of potentiometer at nominal stroke   | ASZ7.3                         | 0...1000 Ω |  |
|                                   |   | ASZ7.31                        | 0...135 Ω  |  |
|                                   |   | ASZ7.32                        | 0...200 Ω  |  |
|                                   | min. current in sliding contact   | 0.05 mA                        |            |  |
|                                   | expected lifetime   | 250'000 full lifts             |            |  |
|                                   | max. current in sliding contact   | 2.5 mA                         |            |  |
|                                   | expected lifetime   | 100'000 full lifts             |            |  |

## Internal diagrams

**MKB632.., MKC632..**  
AC 230 V, 3-position

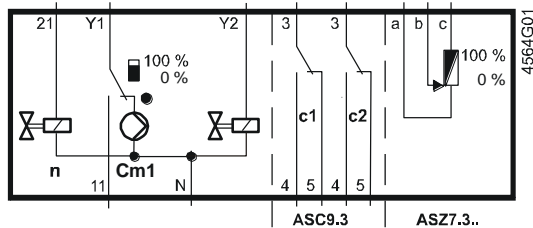

- Cm1** end switch
- n** solenoid valve for spring-return
- c1, c2** ASC9.3 double auxiliary switch
- a, b, c** ASZ7.. potentiometer
- Y1** Positioning signal «open»
- Y2** Positioning signal «close»
- 21** spring-return function
- N** neutral conductor

**MKB662.., MKC662..**  
AC 24 V, DC 0...10 V,  
4...20 mA, 0...1000 Ω

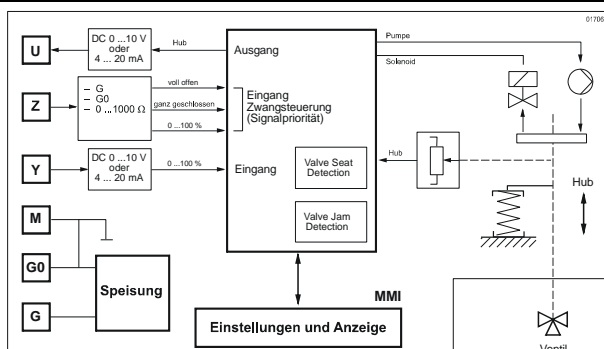

- U** position indication
- Z** override control
- Y** positioning signal
- M** measuring neutral
- G0** operating voltage AC 24 V: system neutral (SN)
- G** operating voltage AC 24 V: system potential (SP)

## Connection terminals

**MKB662.., MKC662..**

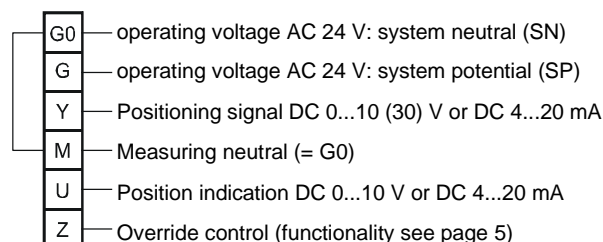

**Auxiliary switch  
ASC1.6**

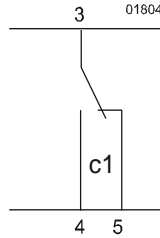

**Connection diagrams**

**MKB632..., MKC632..**  
3-position

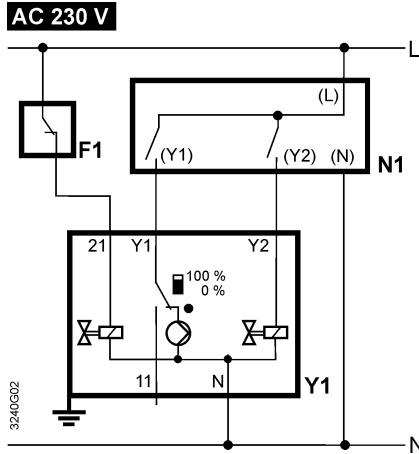

- F1** temperature limiter
- N1, N2** controller
- Y1, Y2** actuators
- L** Phase
- N** neutral
- (Y1)** controller contacts
- (Y2)** controller contacts
- Y1** Positioning signal «open»
- Y2** Positioning signal «close»
- 21** spring-return function

**MKB662..., MKC662..**  
DC 0...10 V, 4...20 mA,  
0...1000 Ω

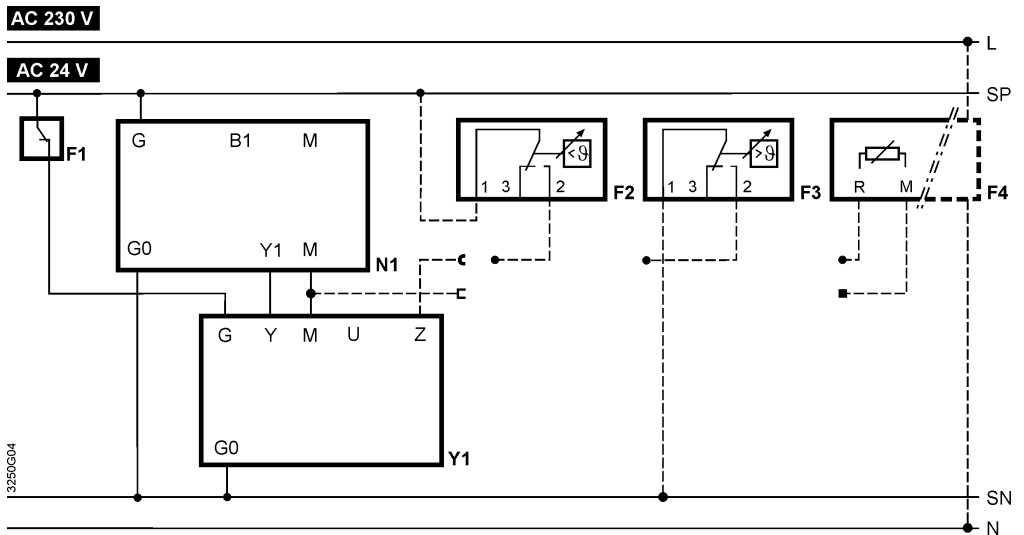

- Y1** actuator
- N1** controller
- F1** temperature limiter
- F2** frost protection thermostat  
terminals: 1 – 2 frost hazard / sensor is interrupted (thermostat closes with frost)  
1 – 3 normal operation
- F3** temperature detector
- F4** frost protection monitor with 0...1000 Ω signal output \*
- G (SP)** System potential AC 24 V
- G0 (SN)** System neutral

\* QAF21.. and QAF61.. frost protection monitor cannot be connected with control devices MK..6...

# Dimensions

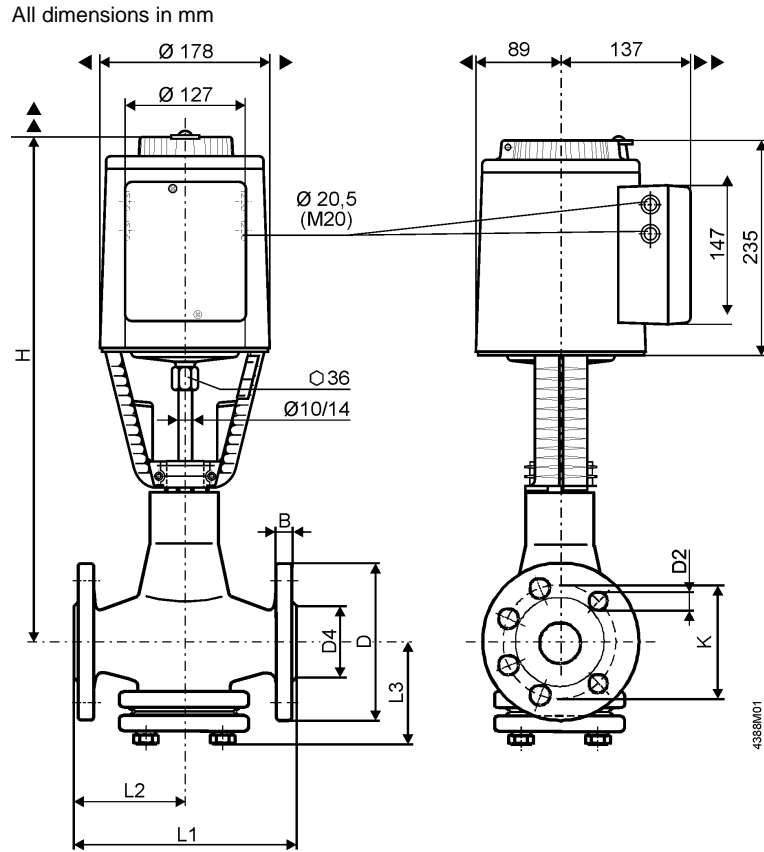

Minimum clearance from ceiling or wall for mounting, connection, operation, maintenance etc.

- ▶ => 100 mm
- ▶▶ => 200 mm

| DN  | B  | D<br>Ø | D2<br>Ø | D4<br>Ø | K<br>Ø | L1  | L2  | L3  | H     |       | kg    |       |
|-----|----|--------|---------|---------|--------|-----|-----|-----|-------|-------|-------|-------|
|     |    |        |         |         |        |     |     |     | MKB.. | MKC.. | MKB.. | MKC.. |
| 15  | 16 | 95     | 14 (4x) | 46      | 65     | 130 | 65  | 90  | 471   | 511   | 16,3  |       |
| 25  | 18 | 115    |         | 67      | 85     | 160 | 80  | 107 | 486   |       | 18,9  |       |
| 40  |    | 150    | 19 (4x) | 84      | 110    | 200 | 100 | 102 | 511   |       | 24,9  |       |
| 50  | 20 | 165    |         | 99      | 125    | 230 | 115 | 107 | 511   |       | 26,9  |       |
| 65  | 22 | 185    | 18 (8x) | 118     | 145    | 290 | 145 | 138 |       | 537   |       | 39,5  |
| 80  | 24 | 200    |         | 132     | 160    | 310 | 155 | 150 |       | 545   |       | 45,5  |
| 100 |    | 235    | 22 (8x) | 156     | 190    | 350 | 175 | 173 |       | 555   |       | 62,5  |
| 125 | 26 | 270    | 26 (8x) | 184     | 220    | 400 | 200 | 195 |       | 575   |       | 85    |
| 150 | 28 | 300    |         | 211     | 250    | 480 | 240 | 219 |       | 600   | 120,5 |       |

DN = Nominal size

## Revision numbers for control devices MK..6..

| Type     | Valid from Rev.-No.                                   |   |
|----------|---|---|
| MKB632.. | <b>Actuator</b> , refer to data sheet N4564: SKB32.51 | <b>Valve</b> , refer to data sheet N4382: VVF61.. |
| MKB662.. | <b>Actuator</b> , refer to data sheet N4564: SKB62    | <b>Valve</b> , refer to data sheet N4382: VVF61.. |
| MKC632.. | <b>Actuator</b> , refer to data sheet N4566: SKC32.61 | <b>Valve</b> , refer to data sheet N4382: VVF61.. |
| MKC662.. | <b>Actuator</b> , refer to data sheet N4566: SKC62    | <b>Valve</b> , refer to data sheet N4382: VVF61.. |