

SIEMENS

SIPROTEC 7SJ531 Numerical Line and Motor Protection with Control Functions

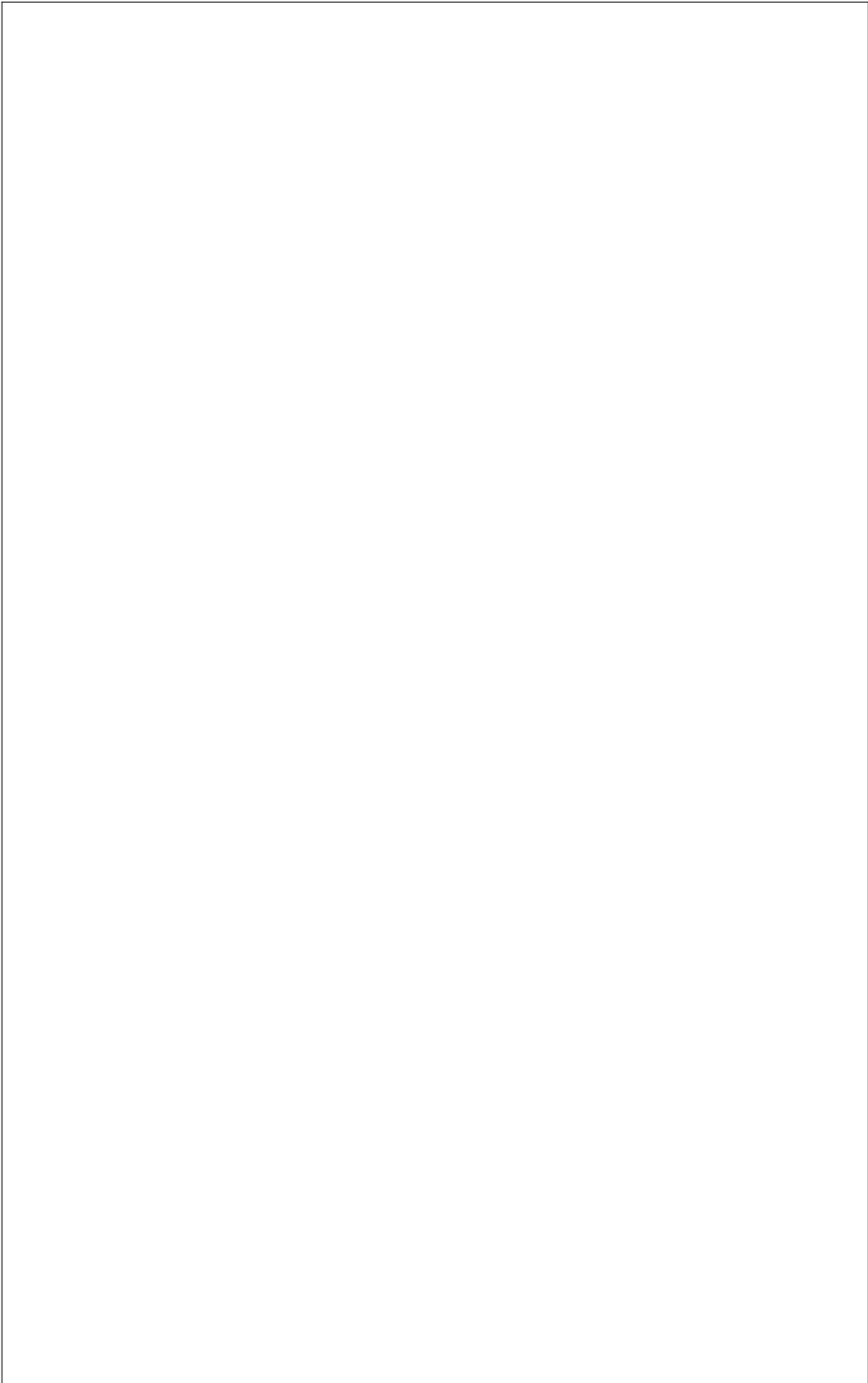

Protection Systems

Catalog LSA 2.1.9
October 1997

SIPROTEC 7SJ531 (Version V3.2) Numerical Line and Motor Protection with Control Functions

Protection systems

Page

Features	2
Description	3 to 6
Feeder control diagrams	7 and 8
Functions	9 to 15
Typical applications	16 to 19
Technical data	20 to 23
Selection and ordering data	24
Connection diagram	25
Dimension drawings (in mm)	26
Technical specification	27
Index of catalogs	28
Conditions of sale and delivery	28

Catalog LSA 2.1.9 · October 1997

Supersedes: Catalog LSA 2.1.9 · 1997

SIPROTEC 7SJ531 (Version V3.2)

Numerical Line and Motor Protection with Control Functions

Features

Line protection

- Overcurrent-time protection, phase and earth-fault protection, either definite-time or inverse-time (IEC or ANSI)
- Reverse interlocking
- Overload protection acc. to IEC 255-8
- Undervoltage and overvoltage protection
- Automatic reclosure
- Sensitive earth-fault detection
- Circuit-breaker failure protection
- Directional overcurrent-time protection
- Directional comparison protection
- Unbalanced-load protection
- Fault locator
- Switch-onto-fault.

Motor protection

- Overcurrent-time protection
- Stator overload protection with 2 time constants
- Starting time monitoring (locked-rotor protection)
- Start inhibit
- Unbalanced-load protection
- Undercurrent detection.

Transformer protection

- Overcurrent-time protection
- Overload protection (IEC 255-8)
- Unbalanced-load protection.

Control

- 1 switching device via the integrated operating panel, 2 binary inputs, DIGSI or LSA/SCADA
- The positions of up to 5 switching elements are shown on the graphic display
- 22 feeder control diagrams for single and duplicate busbars for adaptation to the switching bay
- Local-remote switching.



ANSI	IEC	ANSI	IEC
27	$V_{<<, t}; V_{<, t}$	51N	$I_{E>>, t}; I_{E>, t}; I_{Ep}$
	- $P>; Q>$	51BF	CB $I>, t$
37	$I_{<}$	55	$\cos \varphi <$
46	$I_{2>>, t}; I_{2>, t}$	59	$V>, t$
47	phase sequence monitoring	64	$V_{0>, t}$
48	starting time monitoring	67N	$I_{EE>>, t}; I_{EE>, t}$
49	$\vartheta>$, IEC 255-8	67	$I_{dir.>>, t}; I_{dir.>, t}$
50	$I>>$	79	auto-reclosure
50N	$I_{E>>}$		- start inhibit
51	$I>>, t; I>, t; I_p$		- trip circuit monitoring

Fig. 1
7SJ531 numerical overcurrent-time protection (flush mounting housing)

Monitoring

- Operational measured values I, V, P, Q, θ, f
- Energy metering values W_p, W_q
- Threshold values $P>, Q>, \cos \varphi <$
- Time metering of operating hours.

Additional functions

- Trip circuit monitoring
- Parameter set change-over
- User-definable characteristics for overcurrent-time protection, directional overcurrent-time protection and directional earth-fault detection
- Test OPEN and test OPEN-CLOSE cycle (Trip contact testing)
- Fault recording
8 fault event protocols
8 fault oscillographic recordings.

Communication

- IEC 870-5-103 interface to LSA/SCADA
- PC with DIGSI
- via modem.

Hardware

- Auxiliary voltages 24/48/60/110/125/220/250 V DC
- Local control
- Graphic display
- Analog inputs
5 current transformers
3 voltage transformers
- Digital inputs/outputs
11 binary inputs
5 alarm relays
4 command relays.

Description



Application

The 7SJ531 is a numerical combined control, protection and monitoring device. As a line protection device it is used for medium-voltage networks with low-resistance earthing, solid earth (grounded), isolated or compensated starpoint. It is equally suitable for radial networks fed from one side or for open rings, as well as for lines fed from two sides or for closed rings.

As a motor protection relay the 7SJ531 is suitable for asynchronous machines of all sizes and as back-up protection it is well suited for equipment requiring differential protection such as lines, transformers or generators.

The integrated control functions allow control of the switching device via the integrated operating panel, 2 binary inputs, DIGSI or LSA/SCADA. Various types of switchgear with single and duplicate busbar which contain a controllable switching device, are supported.

Design

Within its compact design, the unit contains:

- All components for analog value acquisition and numerical evaluation
- Integrated keypad and graphic display with feeder control diagram
- Indication and command outputs
- Binary inputs
- Serial interfaces for parameterization and connection to substation control and protection
- Auxiliary voltage converter.

The device can be supplied with two different housings. The housing for panel flush or cubicle mounting has rearside connection terminals. The housing designed for panel surface mounting is provided with two-tier terminals accessible from above and below.

Constant self-monitoring

Hardware and software are constantly monitored and irregularities immediately detected and signalled. This ensures a very high degree of safety, reliability and availability.

Improved measurement technique

With the use of a powerful micro-processor and numerical analog value conditioning and processing, the effect of high-frequency transients and transient DC components are largely suppressed.

The definite-time characteristics measurement evaluates the fundamental component of the current (from a Fourier analysis). If inverse-time characteristics are chosen there is a choice between rms value or fundamental calculation.

Reliable battery checks

The supplied battery serves to back up the real time clock, the operational and fault indications as well as the fault recording in the event of power supply failure. Its function is checked by the processor at regular intervals. If the capacity of the battery declines, an alarm annunciation is initiated. A prophylactic exchange at regular intervals is therefore not necessary.

SIPROTEC 7SJ531 (Version V3.2)

Numerical Line and Motor Protection with Control Functions

Description

Serial interfaces

(see Fig. 3)

The device is equipped with two serial interfaces. The operating interface on the front panel is suitable for the connection of a WINDOWS capable PC. The DIGSI operating and analysis software allows easy setting, fault recording evaluation and commissioning. The system interface is an 820 nm fibre-optic interface for linking to the LSA 678 substation control and protection system or a protection master unit (protocol acc. to IEC 870-5-103). DIGSI can also be connected to the system interface. This is useful if all devices of a substation are to be connected to a PC via star coupler for remote handling. It includes control, parameter setting, status indication reading and fault recording. One 7SJ531 protection device can either be connected directly to a PC or up to 255 devices of a substation can be controlled via a star coupler. If star coupler and modem are combined, the devices can be accessed via telephone line.

Convenient settings

(see Fig. 4)

Using the integrated operating panel and the graphic display, the individual parameters can be set by entering a code number under menu guidance or by entering the direct addresses of individual parameters. The PC program DIGSI permits configuration and parameterization of the 7SJ531 in advance on the PC. The stored data can be loaded into the protection device via one of the interfaces. They are stored in non-volatile memories so that setting values are retained even if the power supply should fail.

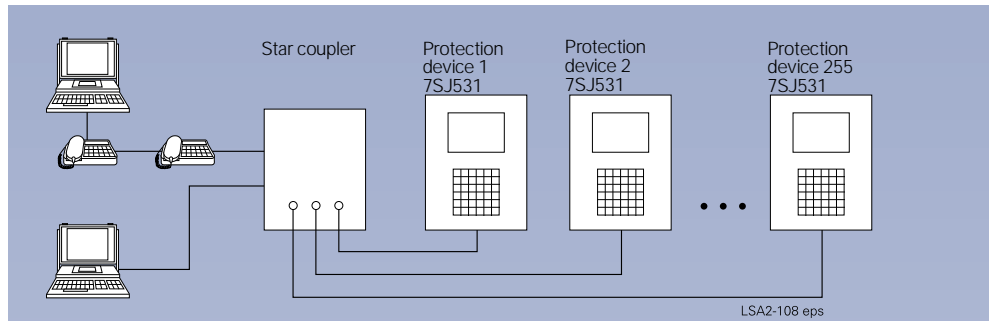

Fig. 3 Operating of protection devices with DIGSI

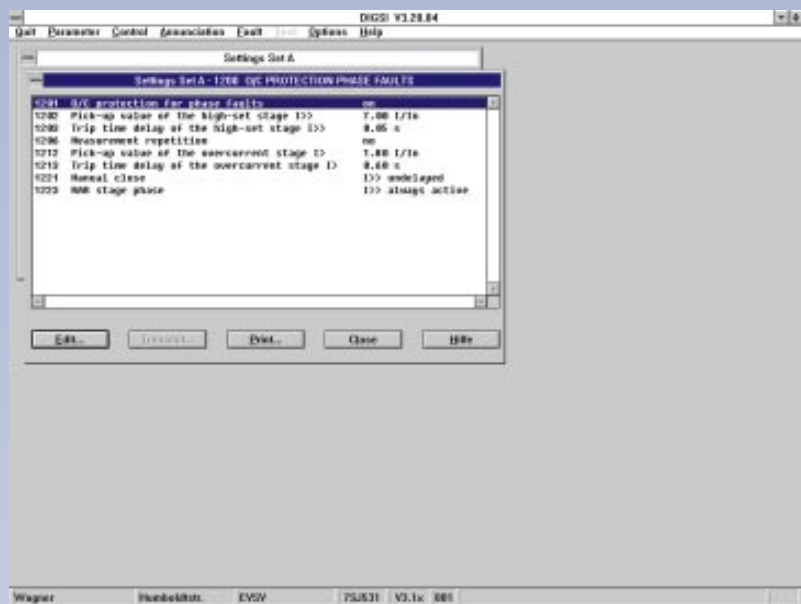

Fig. 4 Parameter setting with DIGSI



Fig. 5 Fault record of analog and binary traces

Fault recording up to 5 sec (see Fig. 5)

The digitized values of the phase and earth currents as well as the line and zero sequence voltages are stored in a fault recording which may be initiated either upon pick-up or after the trip command has been released.

Furthermore, recording of a fault event can be started via a binary input, if an external protection device has tripped. For test purposes it can also be initiated via the integrated keyboard or via DIGSI.

The analog values recorded can be transferred to a PC where they can be conveniently analyzed and processed. If recorded faults exceed the total recording duration of 5 seconds, the oldest fault recorded is overwritten.

Indications with time stamp

The 7SJ531 provides detailed data for analyzing faults and checking states during operation. All the following indications are protected against supply voltage failure.

- Real-time clock
As a standard a battery-backed real-time clock is available and can be synchronized via a binary input or the system interface. All events are recorded with a date and time tag.
- Fault indications
As a rule, the eight most recent faults are recorded. The indications of the faults are available with a resolution of 1 ms.
- Operational indications
All indications that do not immediately refer to a fault (e.g. operating or switching actions), are stored in the operational indication buffer with a resolution of 1 ms. Memory depth: 60 indications.

Control via modem

DIGSI allows the user to access the protection device via modem. If the substation contains a star coupler, the operational and fault protocols, fault recordings and operational measured values of all protection devices of a substation can be conveniently loaded from a remote PC.

Free assignment (marshaling) of inputs and outputs

The binary inputs not required for position feedback, the output relays and the LEDs can be independently assigned according to user requirements. Up to 20 indications can be assigned to an output, up to 10 indications to an input. For each input it may be determined via settings whether it is to be active with or without voltage.

Graphic display

During normal operation the diagram for the feeder shows the position of the circuit-breaker and of all other switching devices. A bar chart underneath the feeder diagram displays the maximum line current thus indicating the capacity utilization of the feeder unit.

By simply pressing a key, 10 previously user-defined operational measured-values can be displayed simultaneously. For example the line currents, the active and reactive power as well as the metering values for both active and reactive energy.

In the case of a fault event, information such as picked-up phases, stages or protective functions which have tripped or the fault duration can be shown on the display.

Furthermore, operational indications, fault event protocols and all below-mentioned operational measured values can be polled under the respective menu item.

Operational measured values

The following variables are displayed under the menu item operational measured values:

- Currents: I_{L1} , I_{L2} , I_{L3} , I_E , I_{EE}
- Voltages: V_{L1} , V_{L2} , V_{L3} , V_0 , V_{12} , V_{23} , V_{31}
- Power: P , Q
- Power factor $\cos \varphi$
- Metering of both negative and positive energy: W_{p+} , W_{p-} , W_{q+} , W_{q-}
- Frequency f .
- Temperature θ

Threshold value monitoring

- Power: $P >$, $Q >$
- Power factor $\cos \varphi <$
- Currents: $I_{L1} >$, $I_{L2} >$, $I_{L3} >$, $I_E >$, $I <$.

Remote control of parameter set changeover

Via binary inputs, DIGSI, LSA/SCADA or the integrated control panel the user may switch between 2 different parameter sets. Thus, if the power system configuration is changed by switching actions it is possible to simultaneously adapt the settings of the protection devices.

User-defineable characteristics

Instead of using the pre-defined inverse-time characteristics acc. to IEC or ANSI the user may define his own tripping characteristics. For this purpose, up to 20 current-time value pairs are available, which may be selected within a wide range and which allow a finely adjustable graduation. Owing to the linear interpolation between the reference points, only few points need to be entered normally. Separate characteristics are available for the phase overcurrent stage, for the earth overcurrent stage, for the directional overcurrent stages of both earth and phase as well as for one of the sensitive earth-fault stages.

Circuit-breaker check as commissioning aid

For checking the trip circuit the circuit-breaker can be activated via the 7SJ531. Either a TRIP command or a TRIP-CLOSE cycle can be started.

SIPROTEC 7SJ531 (Version V3.2)

Numerical Line and Motor Protection with Control Functions

Description

Trip circuit monitoring

One or two binary inputs can be used for the monitoring of the circuit-breaker trip coil including wiring. An alarm indication will be displayed if the circuit is interrupted.

Control (see Fig. 7)

The 7SJ531 is suitable for use in a medium-voltage bay with single or duplicate busbar which contains one controllable switching unit (circuit-breaker or switch-disconnector). 22 permanently stored feeder control diagrams are available to adapt the device to the bay. They are displayed on the integrated graphic display.

The state of the disconnectors and circuit-breakers is obtained via auxiliary contacts and communicated to the 7SJ531 via two binary inputs each. In this way it is possible to detect not only the defined state CLOSED or OPEN but also an intermediate or fault position.

The 7SJ531 permits the acquisition of up to five switching devices. Of these the circuit-breaker can be controlled via the integrated control panel (code-word protected), two binary inputs, DIGSI or LSA/SCADA (serial interface).

To select the switching authority there is a parameter „Switching authority“ for enabling control command sources. The positions „LOCAL“, „REMOTE“, „LOCAL and REMOTE“ and „DISABLED“ represent all combinations of the switching authority. In addition to this permanent assignment, switching authorization can also be switched between „REMOTE“ and „LOCAL“ using a binary input.

Every switching action and change in circuit-breaker position is logged in the operational indication memory (memory for up to 80 indications).

Command source, switching device, cause i.e. spontaneous change or command and the result of a switching action are recorded.

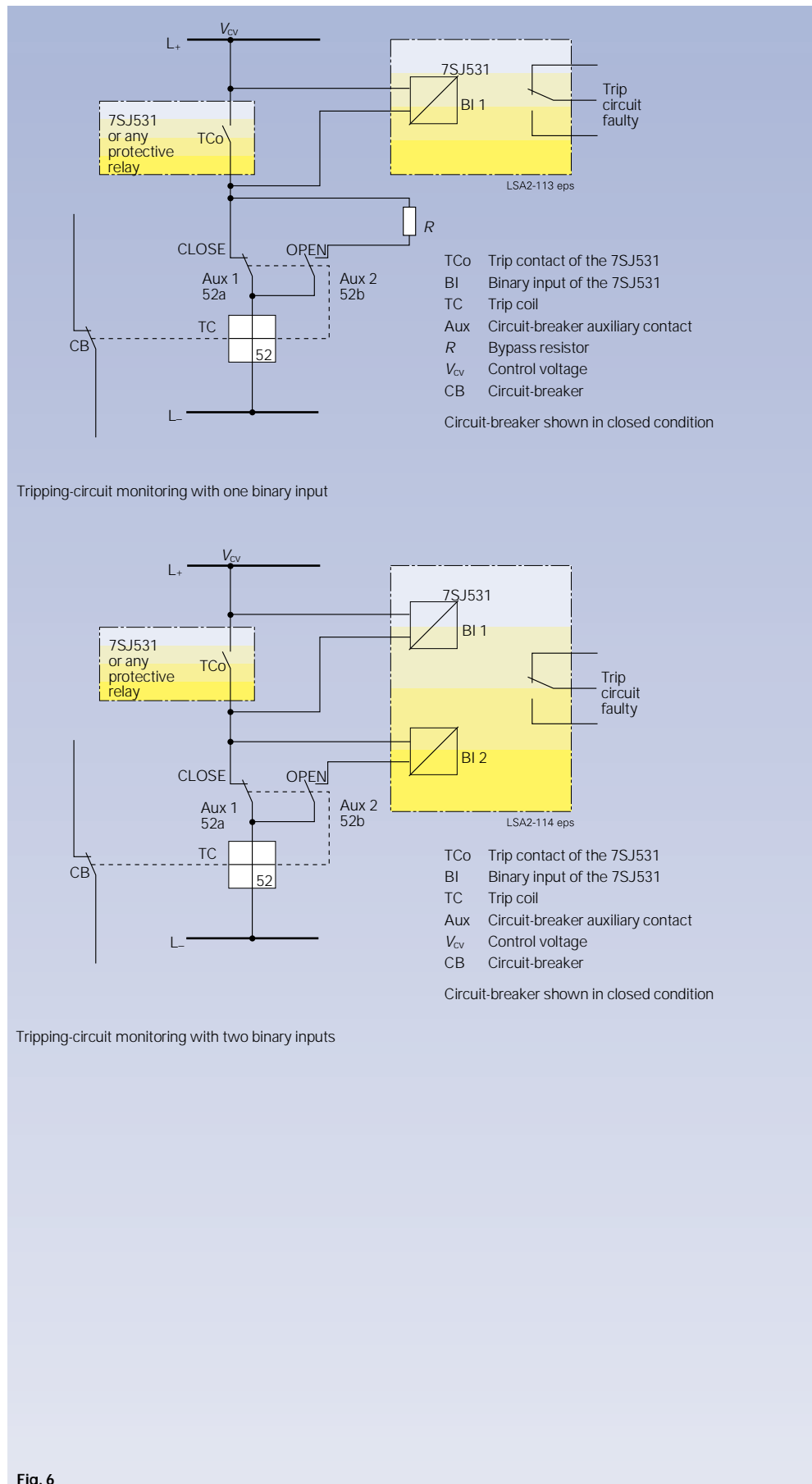
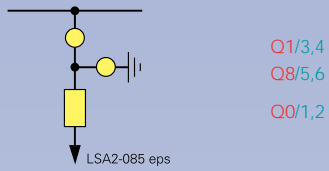

Fig. 6

Feeder control diagrams

Circuit-breaker panel



Circuit-breaker panel with busbar earthing

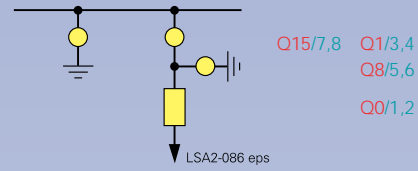

Circuit-breaker panel with measurement and measurement earthing

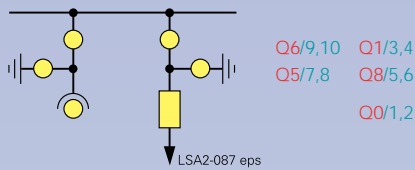

Switch-disconnector panel

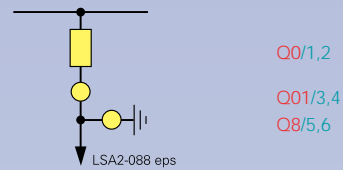

Switch-disconnector panel and busbar earthing

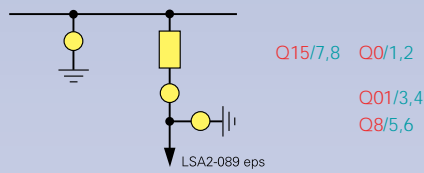

Circuit-breaker panel with duplicate busbar

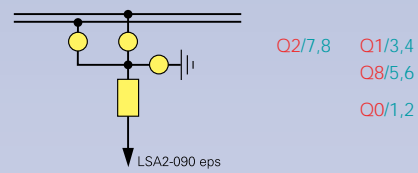

Circuit-breaker panel with duplicate busbar

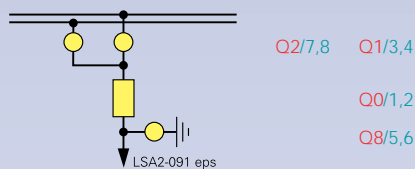

Legend

- Q... Switching elements
- I... Binary inputs

Withdrawable circuit-breaker panel with feeder earthing

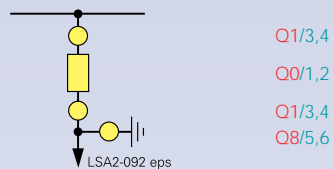

Withdrawable circuit-breaker panel with feeder earthing and busbar earthing

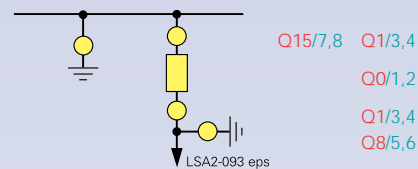

Withdrawable circuit-breaker panel without feeder earthing



Withdrawable circuit-breaker panel without feeder earthing with busbar earthing

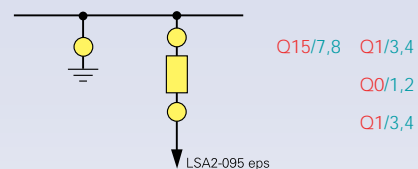

Fig. 7

SIPROTEC 7SJ531 (Version V3.2)

Numerical Line and Motor Protection with Control Functions

Feeder control diagrams

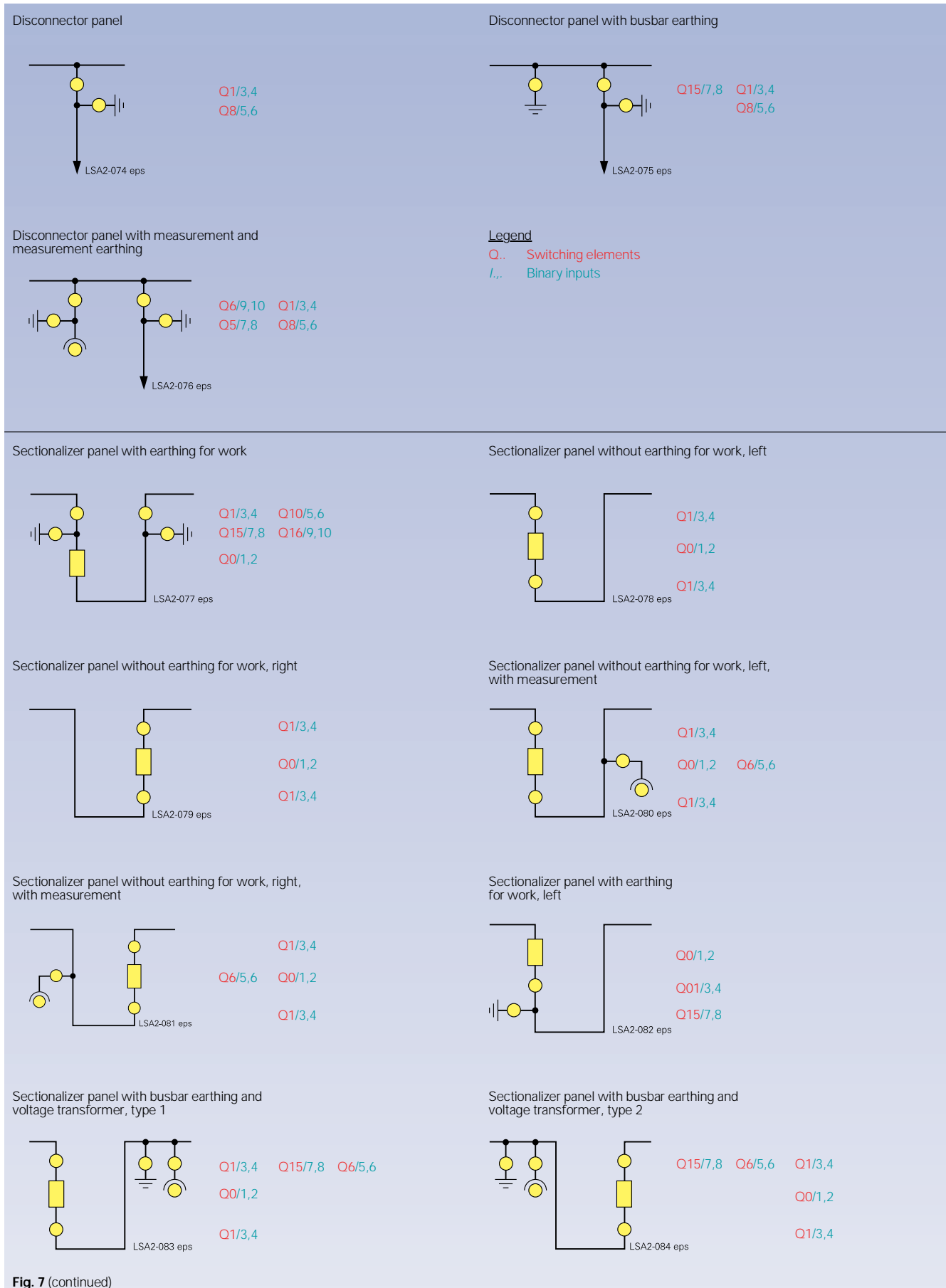

Fig. 7 (continued)

Functions

Overcurrent-time protection (ANSI 50, 50N, 51, 51N)

The function is based on phase-selective measurement of three phase currents and the earth current. In addition to the overcurrent stage there is a high-set current stage both for the phases and for the earth. The high-set current stage always has definite-time a characteristic. For the overcurrent stages either definite-time or inverse-time protection can be selected. For each stage the pick-up value and the delay time (definite time) or the tripping time (inverse time) is selectable within a wide range.

The following tripping characteristics are available for inverse-time overcurrent protection:

Inverse-time characteristics acc. to IEC 255-3 or BS 142

- Inverse
- Very inverse
- Extremely inverse
- Long inverse

- t = tripping time in s
- I = measured current
- I_p = settable threshold value 0.1 to 4 I_N
- T_p = time multiplier

Note for Figs. 8 to 11
Scope of I/I_p from 1.1 to 20

Tripping characteristics of inverse-time overcurrent protection acc. IEC or BS 142

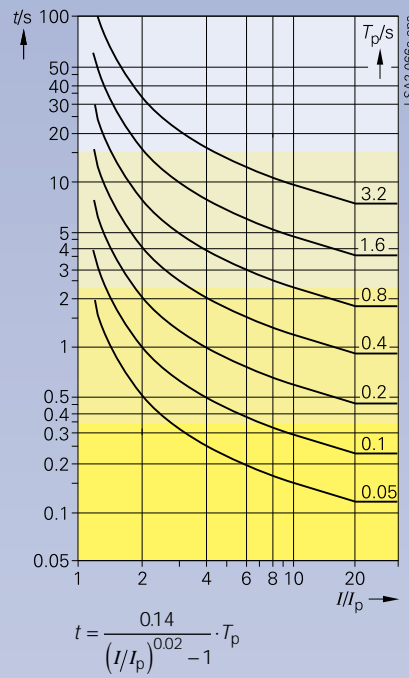

← Fig. 8
Inverse

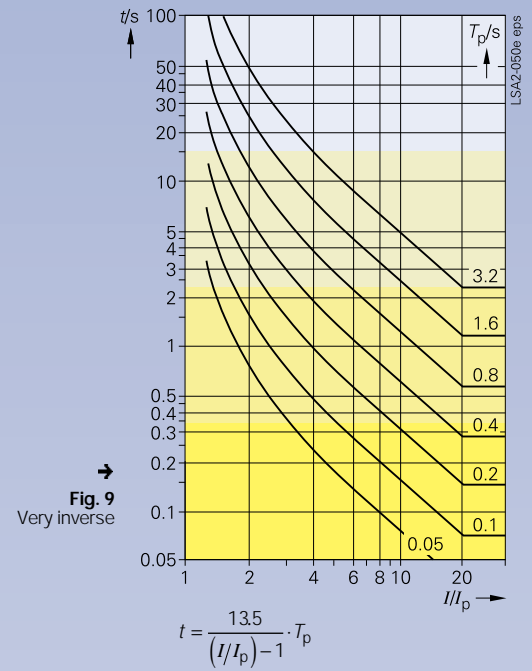

→ Fig. 9
Very inverse

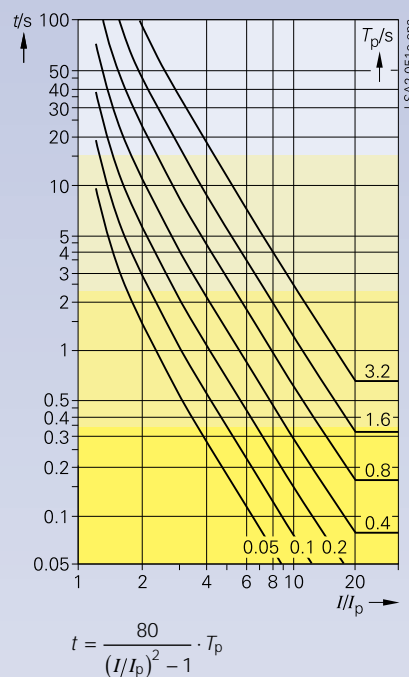

← Fig. 10
Extremely inverse

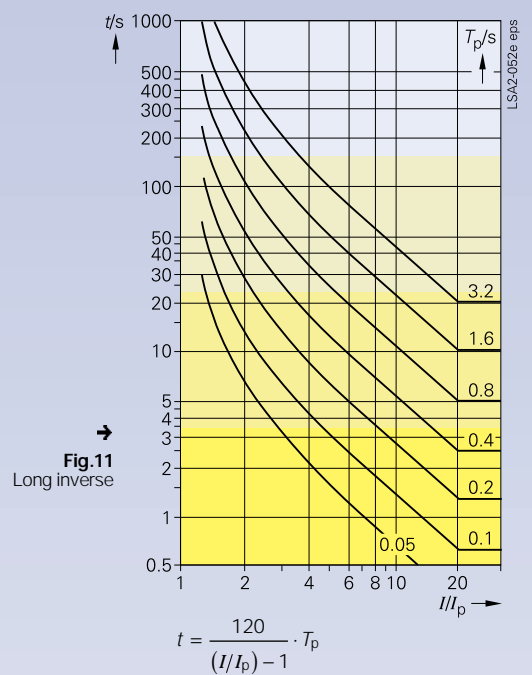

→ Fig. 11
Long inverse

SIPROTEC 7SJ531 (Version V3.2)

Numerical Line and Motor Protection with Control Functions

Functions

Inverse-time characteristics
acc. to ANSI/IEEE

- Inverse
- Short inverse
- Long inverse
- Moderately inverse
- Very inverse
- Extremely inverse
- Definite inverse
- I squared T

- t = tripping time in s
- I = measured current
- I_p = settable threshold value 0.1 to 4 I_N
- D = time multiplier

Note for Figs. 12 to 19
Scope of I/I_p from 1.1 to 20

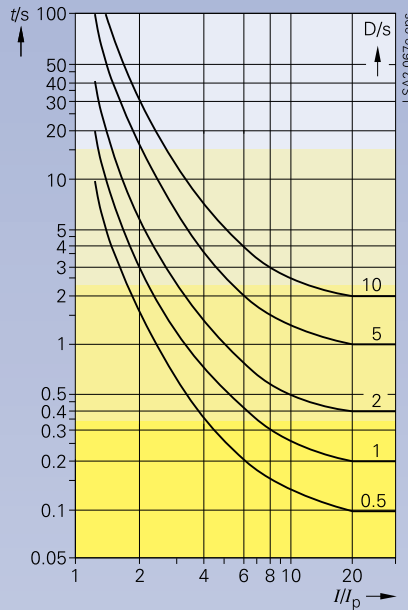

← Fig. 12
Inverse

$$t = \left(\frac{8.9341}{\left(\frac{I}{I_p} \right)^{2.0938} - 1} + 0.17966 \right) \cdot D$$

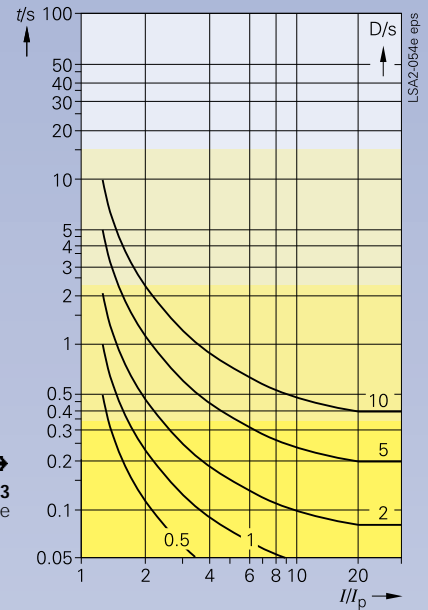

→ Fig. 13
Short inverse

$$t = \left(\frac{0.2663}{\left(\frac{I}{I_p} \right)^{12.969} - 1} + 0.03393 \right) \cdot D$$

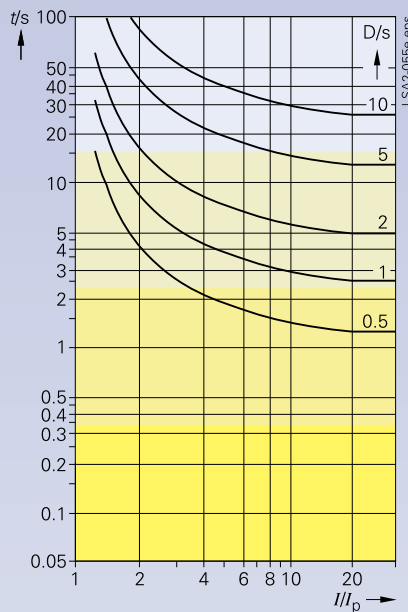

← Fig. 14
Long inverse

$$t = \left(\frac{5.6143}{\left(\frac{I}{I_p} \right) - 1} + 2.18592 \right) \cdot D$$

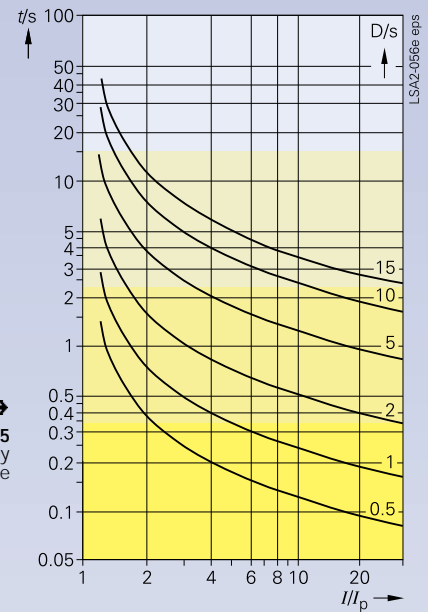

→ Fig. 15
Moderately inverse

$$t = \left(\frac{0.0103}{\left(\frac{I}{I_p} \right)^{0.02} - 1} + 0.0228 \right) \cdot D$$

Switch-onto-fault protection

If the 7SJ531 detects a manual close onto a fault, an instantaneous trip can be issued. If closing is effected via an external switch - thus bypassing the control function of the 7SJ531 - this closing action must be communicated to the 7SJ531 via a binary input. If the internal control function is used (locally, via binary input or via serial interface) the manual-close function is available without requiring additional wiring.

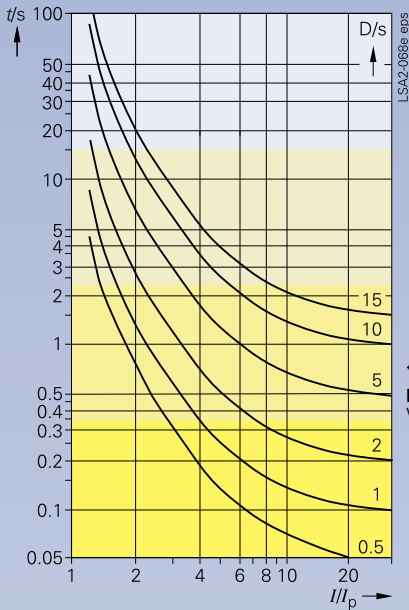

← **Fig. 16**
Very inverse

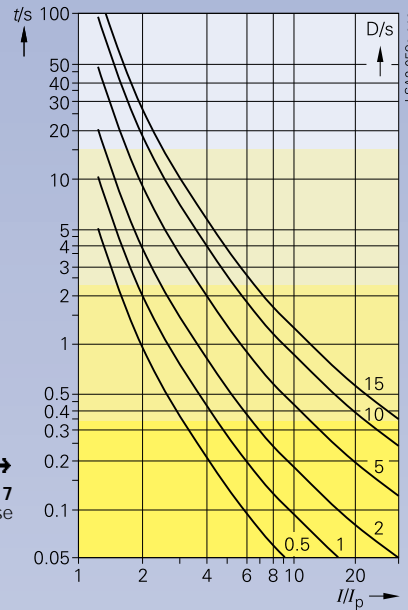

→ **Fig. 17**
Extremely inverse

$$t = \left(\frac{3.922}{(I/I_p)^2 - 1} + 0.0982 \right) \cdot D$$

$$t = \left(\frac{5.64}{(I/I_p)^2 - 1} + 0.0243 \right) \cdot D$$

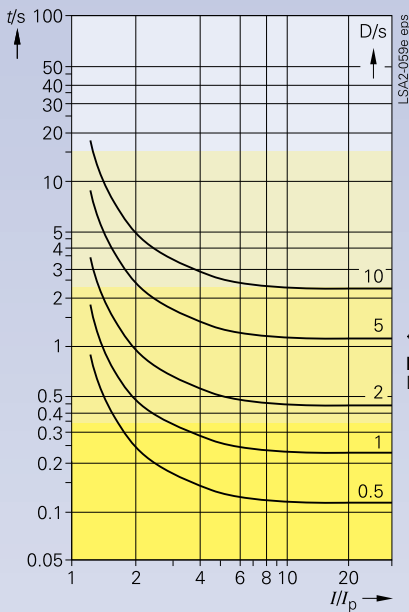

← **Fig. 18**
Definite inverse

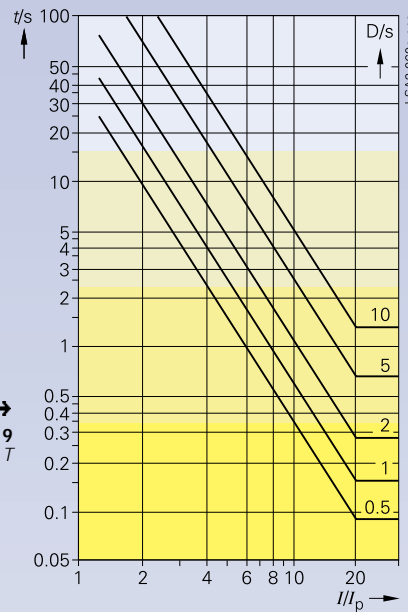

→ **Fig. 19**
I squared T

$$t = \left(\frac{0.4797}{(I/I_p)^{15625} - 1} + 0.21359 \right) \cdot D$$

$$t = \left(\frac{50.7 \cdot D + 10.14}{(I/I_p)^2} \right)$$

SIPROTEC 7SJ531 (Version V3.2)

Numerical Line and Motor Protection with Control Functions

Functions

Directional earth-fault detection (ANSI 64, 67G)

For isolated and compensated networks the 7SJ531 offers a directional earth-fault detection. The energy flow direction in the zero sequence system is established on the basis of the zero sequence current I_0 and the zero sequence voltage V_0 . In networks with isolated starpoint the content of the reactive current is evaluated, whereas in compensated networks evaluation is based on the active currents. Harmonics are efficiently suppressed by means of a powerful numerical filter. For particular network conditions, e.g. for high-resistance earthed networks with capacitive earth-fault current or low-resistance earthed networks with ohmic inductive currents, the tripping characteristic can be rotated by ± 45 degrees (see Fig. 20).

Because of the low content of the active current in compensated networks, it is recommended to connect the sensitive earth-current input to a core-balance current transformer and to connect the V_0 input to an open delta winding. It is also possible to evaluate the V_0 voltage on the basis of the three phase-to-earth voltages and to emulate the earth current by means of a Holmgreen circuit. In general, this is quite sufficient for isolated networks.

The directional earth-fault detection can be operated with the tripping option or in the "annunciation-only" mode.

The following functions are implemented:

- TRIP via displacement voltage V_E
- Two definite-time stages: $I_{EE} >>$ and $I_{EE} >$ or alternatively a definite-time stage $I_{EE} >>$ and a user-definable characteristic.

Each stage can be operated either forward, reverse or non-directionally.

Directional overcurrent-time protection (ANSI 67, 67N)

The directional detection in the 7SJ531 is phase-selective and is carried out separately for phase and earth faults. The stages for the directional detection run parallel to the non-directional overcurrent stages and can be set independently of these with regard to the pick-up values and the delay-times. There are two stages for both phase and earth, the overcurrent stages having either definite-time or inverse-time characteristics while the high-set current stages always have a definite-time characteristic. The directional overcurrent-time protection comprises the following features:

- Separate settings for phase-to-phase and phase-to-earth faults
- Directional detection for phase-to-phase faults by means of the short-circuit current and the healthy phase-to-phase voltage
- Directional detection for earth faults on the basis of displacement voltage V_E and zero sequence current I_0
- Evaluation of the displacement voltage either on the basis of the phase voltages or by using an open delta winding
- Voltage storage, if voltages drop below the measuring limit.

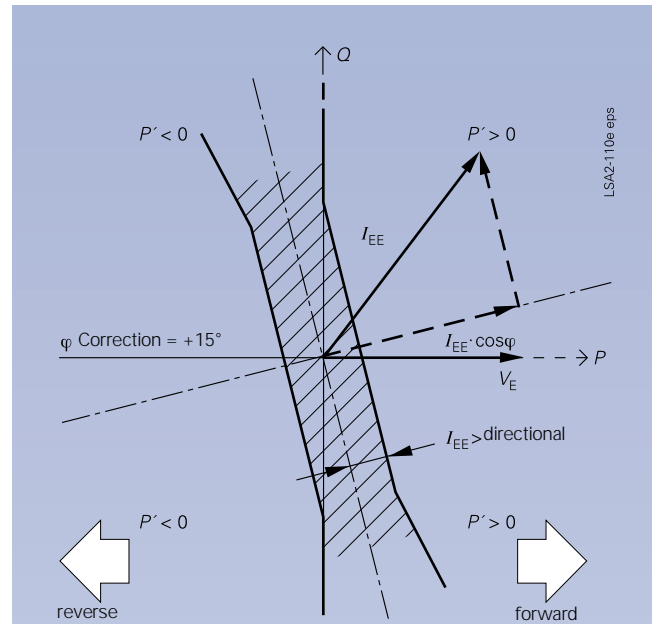

Fig. 20
Directional determination using cosine measurements for compensated networks

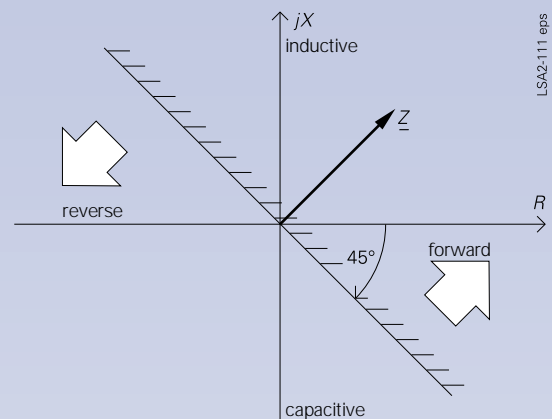

Fig. 21
Directional characteristic of the directional overcurrent-time protection

Reserve interlocking on double-end fed line (cross connection)

This function is used for selective protection of sections with infeed from both sides (e.g. segments of closed rings), without the disadvantageous delay of grading intervals. The directional comparison protection is suitable if the individual protection units are not too far apart and if pilot wires are available for signal transmission. In addition to the directional comparison protection, which provides the main protection, the directional graded overcurrent-time protection serves as a fully selective back-up protection. If operated with signal transmission during quiescent state an interruption of the transmission is signalled.

Voltage protection

When phase-to-earth voltages are connected, either phase-to-earth or phase-to-phase voltages can be evaluated. The latter remains unchanged in the event of an earth fault (isolated or compensated networks).

Overvoltage protection (ANSI 59)

To protect equipment against overvoltage an overvoltage stage with a definite delay time has been integrated. In order to achieve a reset when a feeder is tripped and the voltage transformer is positioned on the busbar side, the current of the feeder can be evaluated in the derivation of fault detection.

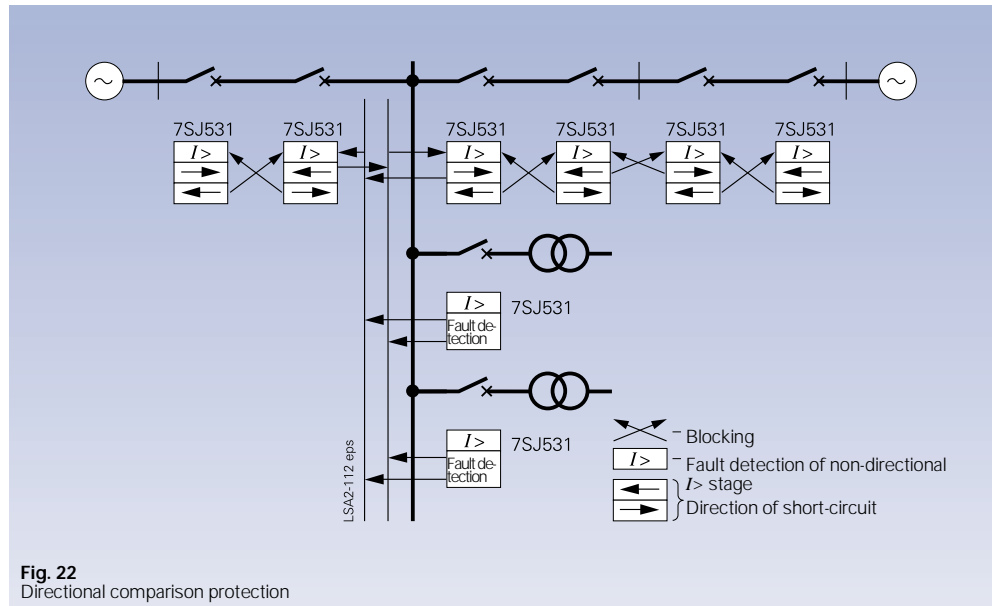

Fig. 22 Directional comparison protection

Undervoltage protection (ANSI 27)

To protect equipment against undervoltage two stages with definite-time delay are provided. To prevent permanent fault detection after trip of circuit-breaker, provided the voltage transformers are located on the feeder side, the current of the feeder can be evaluated in the derivation of fault detection.

Using a startup criterion, the pickup threshold can be changed for the duration of startup when a motor is connected. This allows for the fact that during startup of the motor less severe voltage dips can be tolerated than during rated operation.

Breaker-failure protection (ANSI 51BF)

If a fault is not cleared after a protective trip command, a further command can be released by means of the breaker-failure protection, for instance a command which will affect the circuit-breaker of an up-stream protective device. The breaker failure is detected by the fact that current is still flowing in the respective feeder after the trip-command. As an alternative, the auxiliary contact feedback of the circuit-breaker can be referred to.

Automatic reclosure (ANSI 79)

The 7SJ531 is equipped with automatic reclosure. If the fault is still present even after the last reclosing cycle, lock-out is established. The possible functions are:

- 3-pole tripping
- Separate settings for phase-to-phase and phase-to-earth faults
- Multiple reclosure, rapid auto-reclosure (RAR) and up to nine delayed auto-reclosure cycles (DAR)
- Auto-reclose trigger depending on the stage selective trip command, e.g.
 - high-set overcurrent stage phase
 - overcurrent stage phase
 - high-set overcurrent stage earth
 - overcurrent stage earth
 - corresponding directional short-circuit stages
 - unbalanced-load protection
- Option of blocking auto-reclosure via binary input
- External triggering of auto-reclosure
- Blocking of the directional and non-directional high-set overcurrent stages during the RAR cycle.

Fault locator

Indicates the distance to the fault location in kilometers or miles, or indicates the secondary loop reactance. The fault location can be evaluated either after drop-off, after a trip command or by triggering via a binary input. This means that the fault location can also be evaluated when tripping is initiated by another protection device.

SIPROTEC 7SJ531 (Version V3.2)

Numerical Line and Motor Protection with Control Functions

Functions

Thermal overload protection (ANSI 49)

For the protection of cables or machines, an overload protection with an alarm stage for temperature and current is implemented. The temperature is determined using a thermal homogeneous body model (acc. to IEC 255-8) that takes into account energy input to the equipment and energy output to the environment and which constantly compensates the temperature. Thus previous loading and load fluctuations are taken into account.

Given constant current, the tripping time t is calculated according to the following form:

$$t = \tau \cdot \ln \frac{\left(\frac{I}{k \cdot I_N}\right)^2 - \left(\frac{I_{pre}}{k \cdot I_N}\right)^2}{\left(\frac{I}{k \cdot I_N}\right)^2 - 1}$$

- t = tripping time after beginning of the overload
- τ = thermal time constant
- I_{pre} = pre-load current
- I = overload current
- k = k-factor (in accordance with IEC 255-8)
- \ln = natural logarithm (see Fig. 23)

For the thermal protection of motors (particularly of the stator) an additional time constant τ can be selected to ensure that the thermal conditions are correctly established both when the motor is running and when it is at rest.

The model automatically works correctly, if the equipment is operated within the limits of the ambient temperature for which the producer has specified the maximum loading current. Substantial variations of the ambient temperature (e.g. the summer - winter - difference) can be accounted for via a second parameter set.

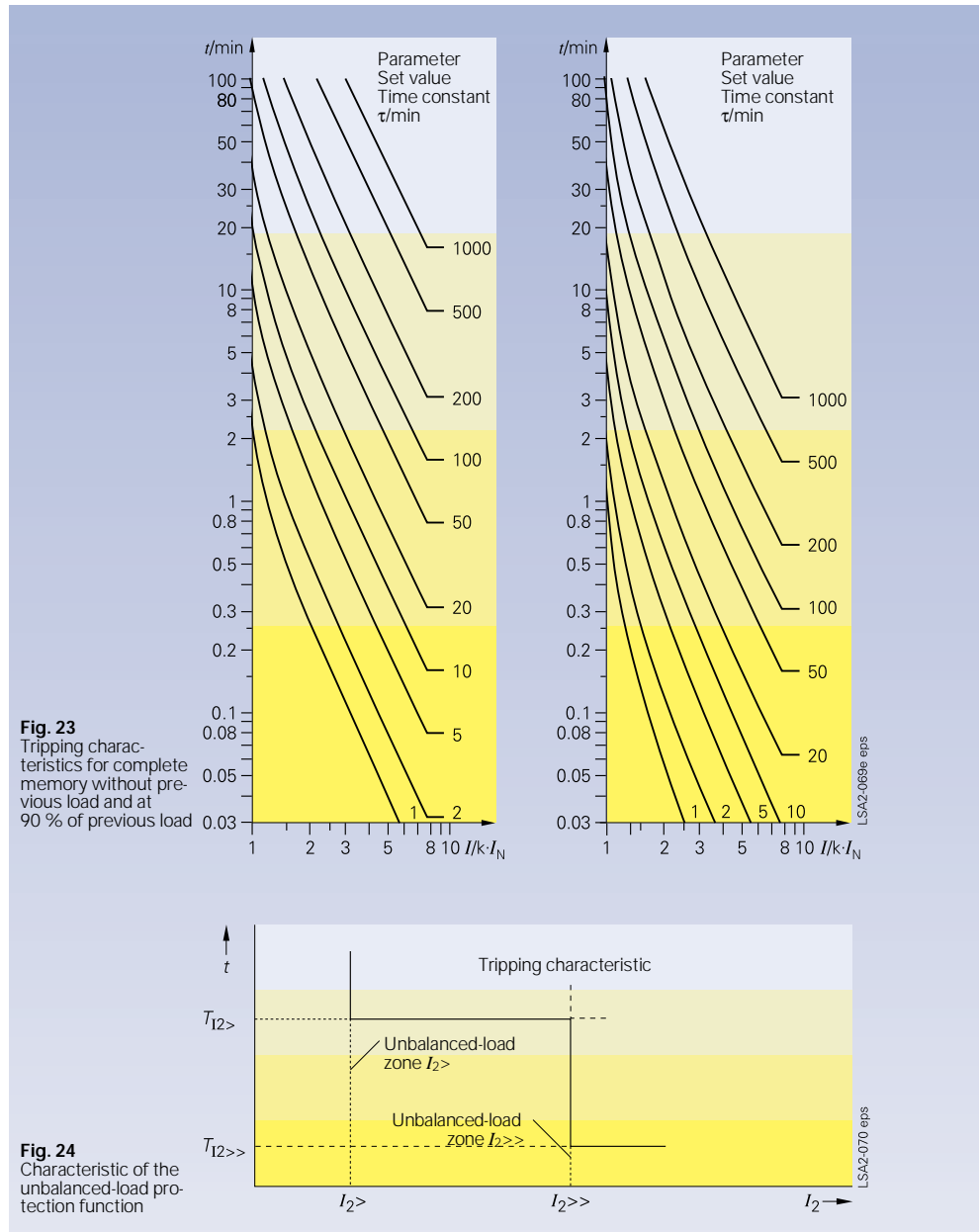

Fig. 23
Tripping characteristics for complete memory without previous load and at 90 % of previous load

Fig. 24
Characteristic of the unbalanced-load protection function

Unbalanced-load protection (ANSI 46)

(see Fig. 24)

The unbalanced-load protection makes it possible to detect on the HV side high-resistance two-pole faults as well as single-pole faults located on the LV side of a transformer e.g. with vector group Dy. Thus a back-up protection for high-resistance faults is provided which extends across the entire transformer.

Applied to a motor, the unbalanced-load protection serves to detect phase failures or unbalanced loads which are due to network unbalance, and to protect the rotor against excessive temperature rise.

For detection of the unbalanced load, the ratio negative-sequence current by rated current is evaluated. There are two definite-time stages.

Starting time monitoring (ANSI 48)

The starting time monitoring protects the motor against unduly prolonged start-ups, which may occur if for instance too high load torques are existant, if too severe voltage dips occur when the motor is being switched on or if the rotor is blocked. An occurrence of the latter type can be communicated to the 7SJ531 via a binary input, so that an instantaneous disconnection is effected. The tripping time is current-dependent. It is obtained according to the following equation:

$$t_{\text{TRIP}} = \left(\frac{I_{\text{Start}}}{I_{\text{rms}}} \right) \cdot t_{\text{Start max}}$$

- t_{TRIP} = tripping time
- I_{Start} = starting current of the motor
- $t_{\text{Start max}}$ = maximum permissible starting time
- I_{rms} = actual flowing current (measured variable)

Using the above formula for the tripping time, even prolonged start-ups with reduced voltage (and reduced starting current) are correctly evaluated.

Start inhibit

If a motor is started too frequently in succession, the rotor, in particular the upper edges of the bars, can be subject to thermal overloading. The start inhibit permits starting of the motor only if the rotor has enough thermal reserve for a complete start.

Emergency start

This function disables the start inhibit via a binary input. In this case, the status of the thermal replica is retained as long as the binary input is active. It is also possible to reset the thermal replica to zero.

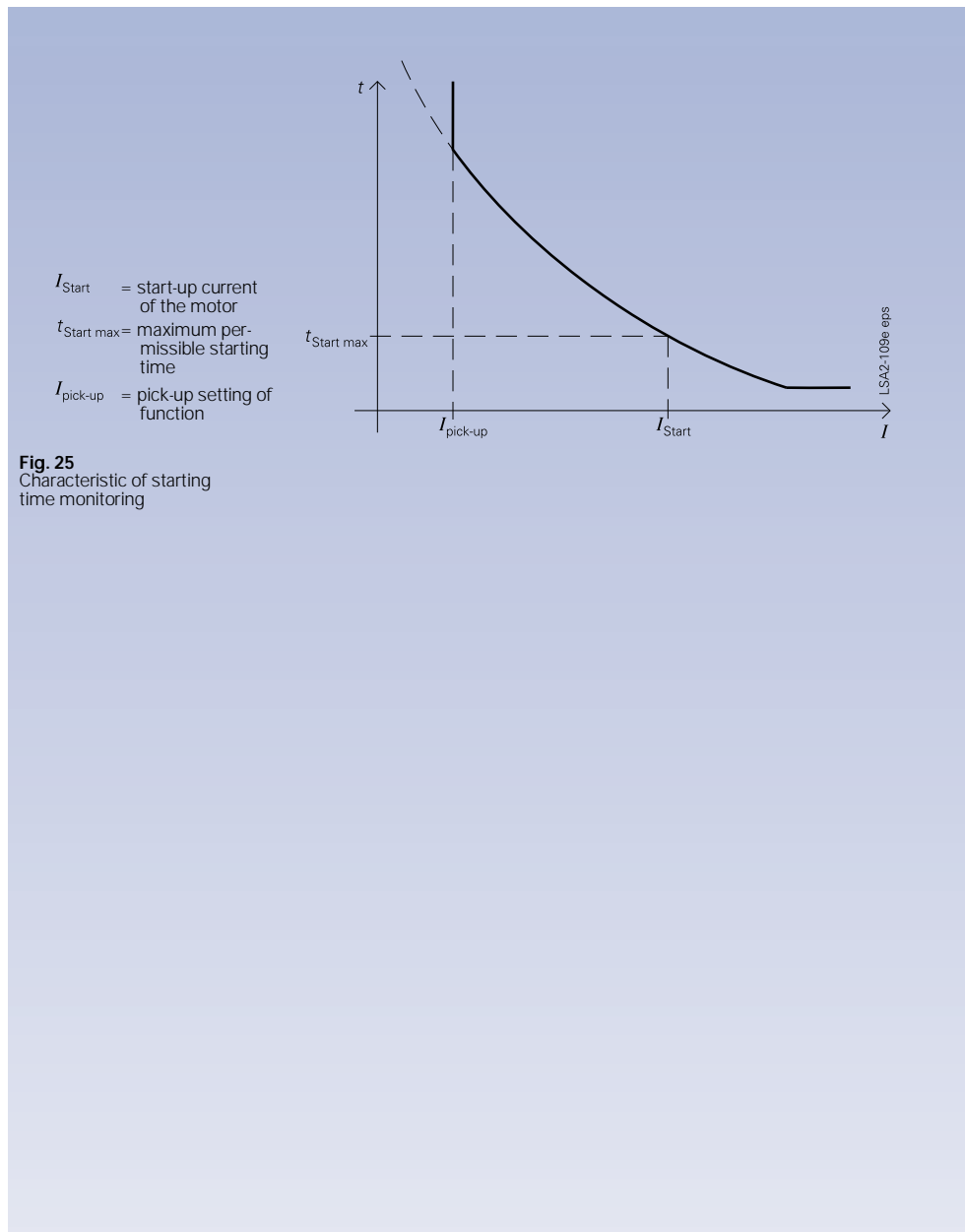

Undercurrent monitoring (ANSI 37)

This function permits detection of a spontaneous current drop-off which may occur due to reduced motor loading. Thus it is possible to detect shaft damage, no-load operation of pumps or blower failure.

SIPROTEC 7SJ531 (Version V3.2)

Numerical Line and Motor Protection with Control Functions

Typical applications

Busbar protection (Reverse interlocking)

The high-set stages of the protection devices can be blocked via a binary input (NC or NO contact). In this manner the 7SJ531 protection device provides a simple and fast protection for single busbars with single-end infeed.

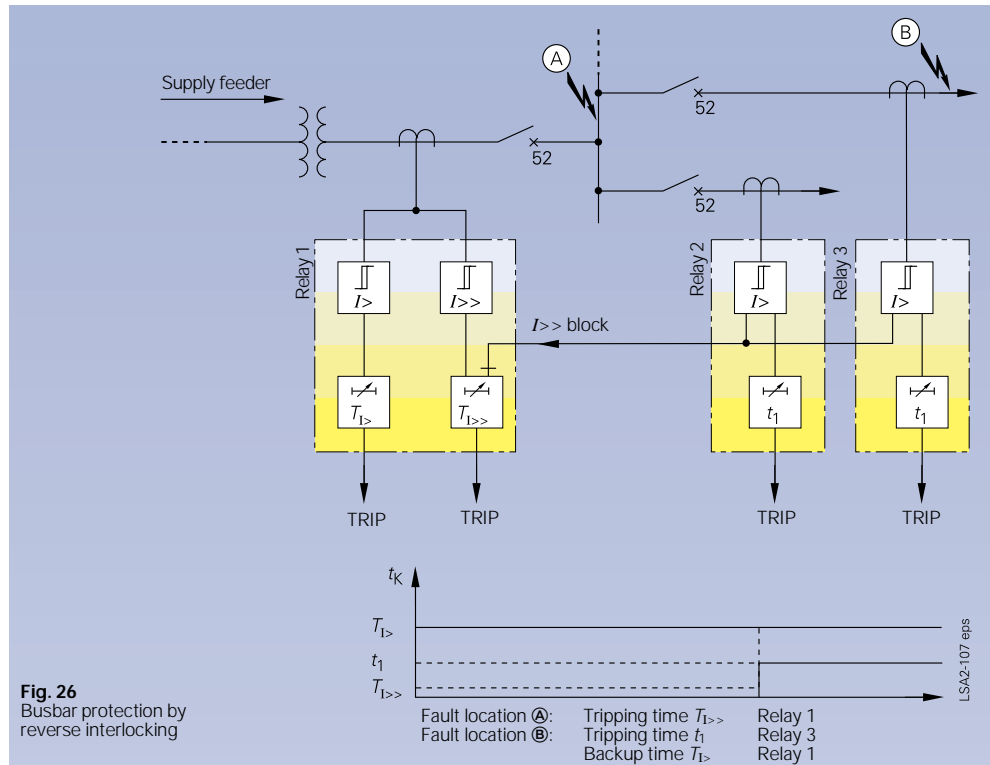

Transformer protection

The high-set stage allows current grading, the overcurrent stages operate as a backup protection for the downstream protection devices and the overload function protects the transformer against thermal overload. Weak-current single-pole faults on the low-voltage side which appear on the high-voltage side in the negative phase-sequence system can be detected by the unbalanced-load function.

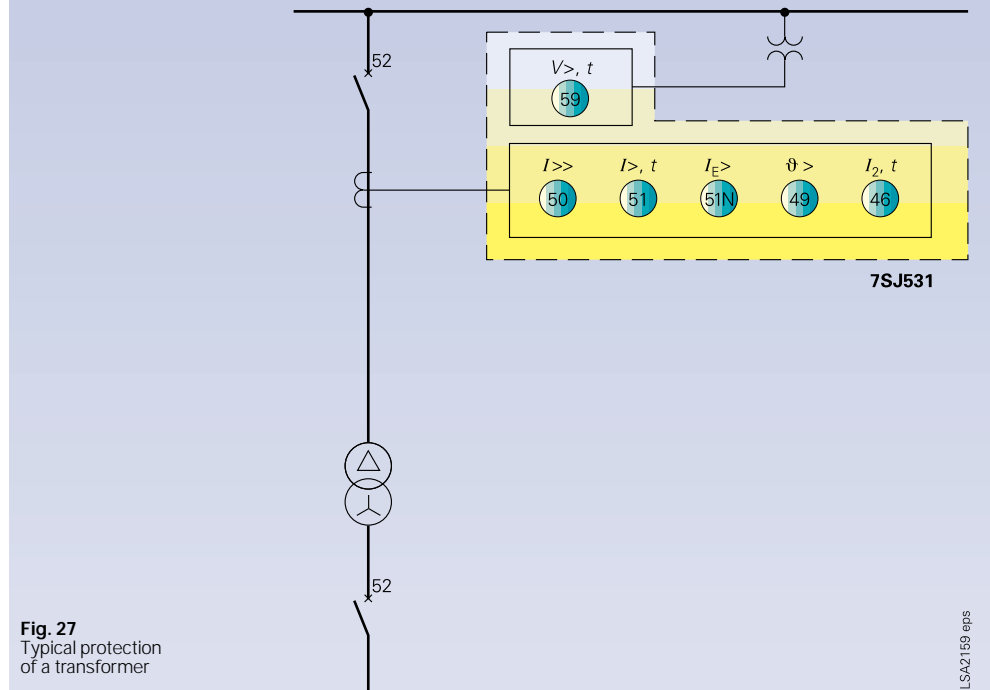

Motor protection

Stage $I_{>>}$ and $I_{E>>}$ can be applied for short-circuit protection. For isolated networks the sensitive earth-fault detection function ($I_{EE>>}$, $V_0>$) can be used. Protection is provided for the stator against thermal overload ($\theta_s>$) and for the rotor ($I_2>$, starting-time monitoring, start inhibit). Via a binary input a locked rotor can be detected and switched off. The under-voltage function prevents starting when voltage is too low, the overvoltage function averts damages of the insulation.

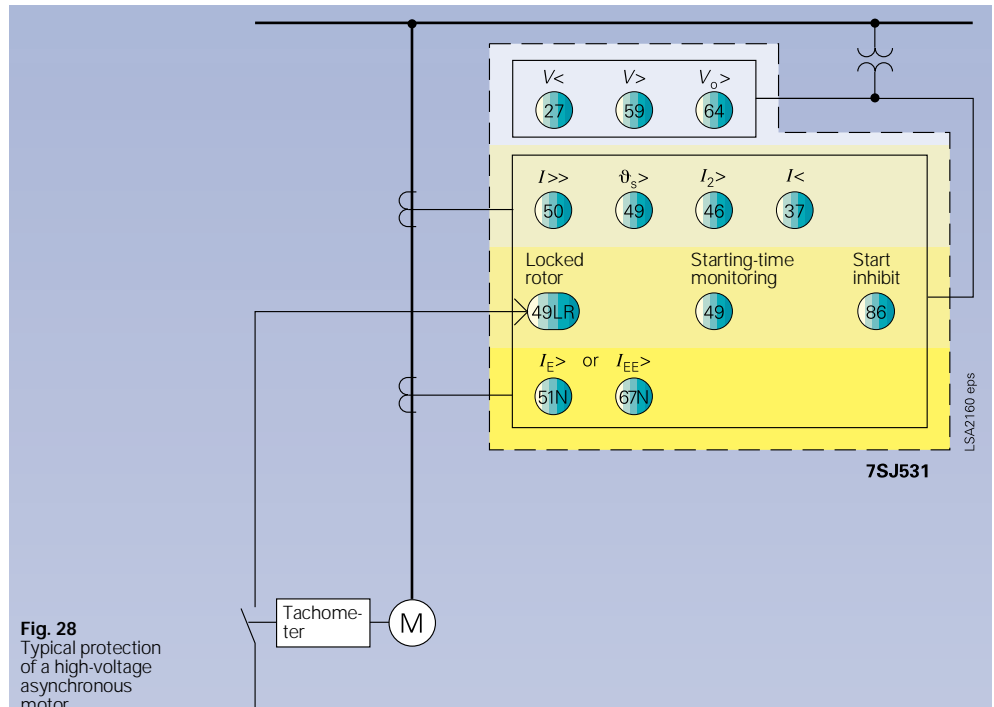

Fig. 28
Typical protection of a high-voltage asynchronous motor

Line protection

Simple ring systems within medium-voltage overhead systems can be protected as shown in Fig. 29.

At the supply terminals an auto-reclose can be employed; the other devices are equipped with directional overcurrent-time protection.

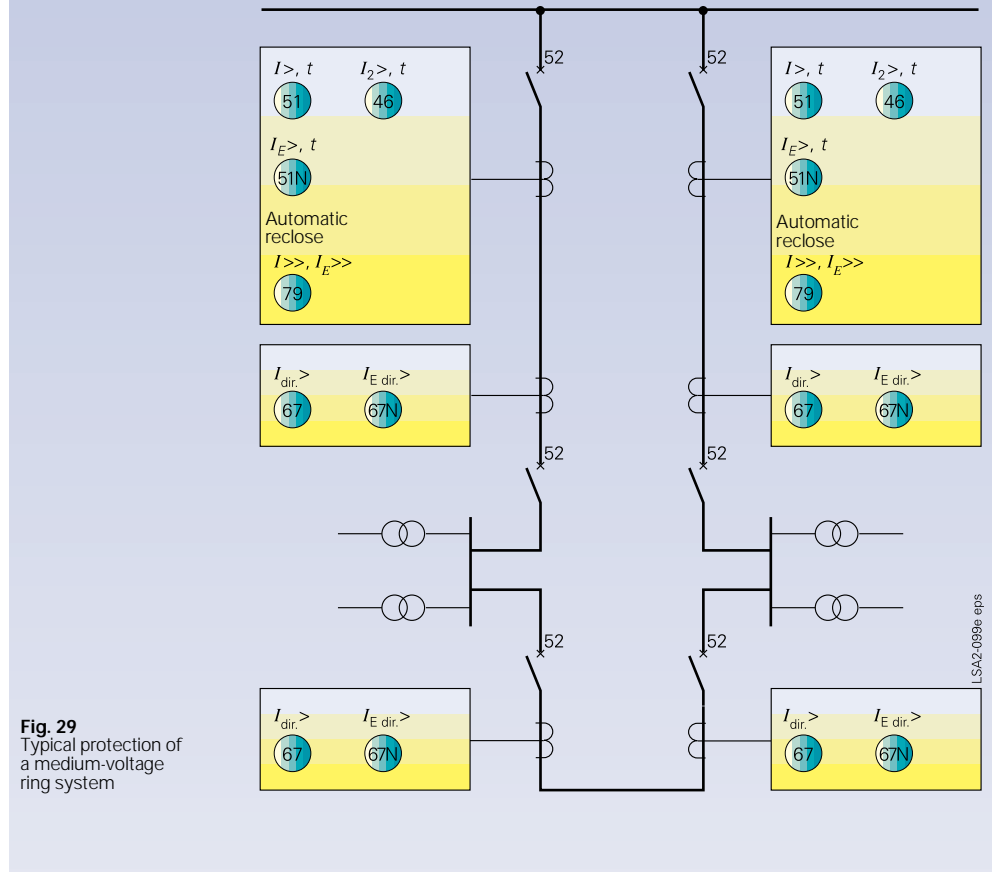

Fig. 29
Typical protection of a medium-voltage ring system

SIPROTEC 7SJ531 (Version V3.2)

Numerical Line and Motor Protection with Control Functions

Typical applications

Standard connection

For earthed networks the earth current is derived via the Holmgreen circuit from the phase currents. Provided the premise $0.1 I_N < I_{\text{earth}} < 1.5 A_{\text{secondary}}$ is met, the Holmgreen circuit can be used. The sensitive I_{EE} transformer has to be looped in the earth current circuit. If the earth current does not comply with the a.m. premise a core-balance current transformer according to Fig. 30 is required.

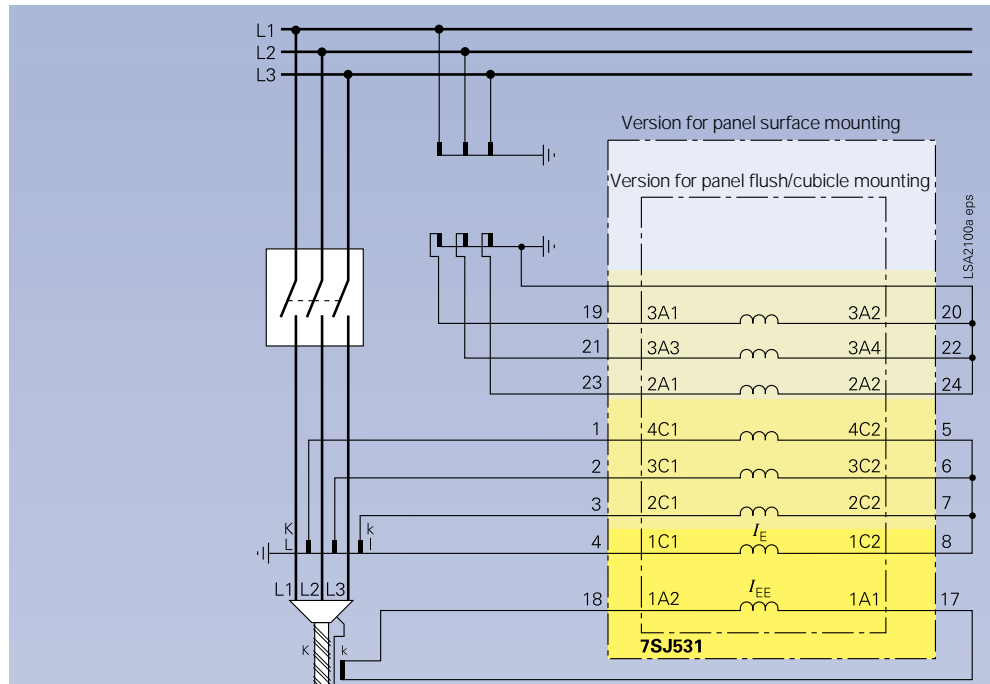

Fig. 30
Connection to 3 voltage transformers

Important! Earthing of cable shield at outgoing cable!
Note: Switching of current polarity (parameter address 1101) causes polarity reversal of current input I_{EE} !

Connection for compensated networks

The diagram shows the connection of two phase-to-earth voltages and the V_e voltages of the open delta winding and a core-balance current transformer for the earth current. This connection provides maximum accuracy in directional earth-fault detection and should be applied in compensated networks.

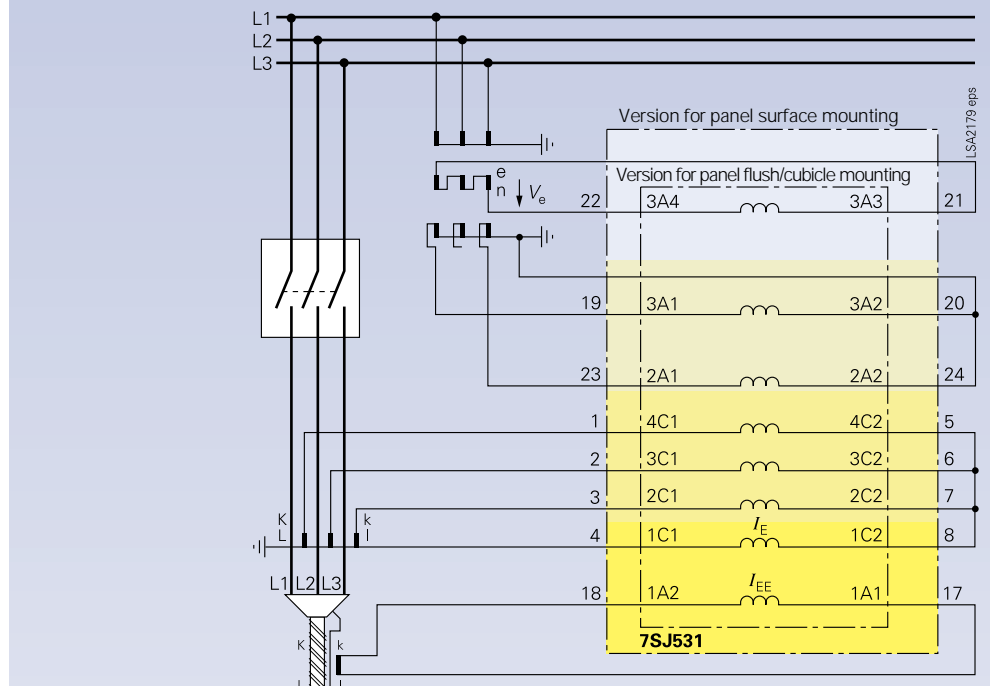

Fig. 31
Connection of an open delta winding

Important! Earthing of cable shield at outgoing cable!
Note: Switching of current polarity (parameter address 1101) causes polarity reversal of current input I_{EE} !

Connection for isolated or compensated networks only

If no directional earth-fault detection is used, a connection with two phase-current transformers is sufficient. For the directional phase-overcurrent-time protection the phase-to-phase voltages detected by two primary voltage transformers are sufficient.

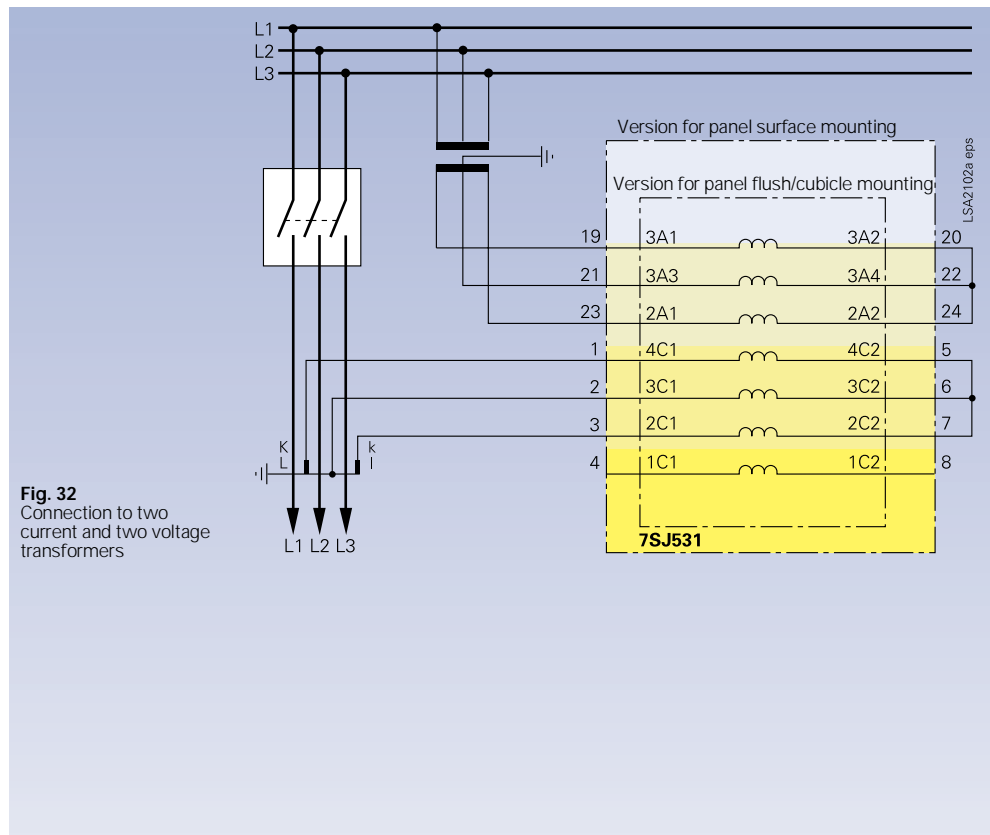

Fig. 32
Connection to two current and two voltage transformers

Overview of connection types

Function	Type of network	Current connection	Voltage connection
Overcurrent-time protection, phases/earth fault, non-directional	(low-resistance) earthed networks	Holmgreen circuit, needed with 3 phase-current transformers, earth with core-balance current-transformers possible	-
Overcurrent-time protection, phase fault, non-directional	isolated or compensated networks	Holmgreen circuit, possible with 3 or 2 phase-current transformers	-
Overcurrent-time protection, phase fault, directional	(low-resistance) earthed networks	Holmgreen circuit, needed with 3 phase-current transformers	phase-to-earth connection or phase-to-phase connection
Overcurrent-time protection, earth fault, directional	(low-resistance) earthed networks	Holmgreen circuit, needed with 3 phase-current transformers, core-balance current transformers possible	phase-to-earth connection needed
Overcurrent-time protection, phase fault, directional	isolated or compensated networks	Holmgreen circuit, possible with 3 or 2 phase-current transformers	phase-to-earth connection or phase-to-phase connection
Sensitive earth-fault protection, $\sin \varphi$ measurement	isolated networks	Holmgreen circuit, if $0.1 I_N < \text{earth current} < 1.5 \text{ A}$ secondary, otherwise core-balance current transformer needed	3 x phase-to-earth connection or phase-to-earth connection with open delta winding
Sensitive earth-fault protection, $\cos \varphi$ - measurement	compensated networks	core-balance current transformers needed	phase-earth connection with open delta winding
Sensitive earth-fault protection	(low-resistance) earthed networks	core-balance current transformers needed	-

SIPROTEC 7SJ531 (Version V3.2)

Numerical Line and Motor Protection with Control Functions

Technical data

Input circuits

Rated current I_N		1 or 5 A
Rated voltage V_N		100 to 125 V
Rated frequency f_N		50 or 60 Hz
Thermal overload capability	in voltage path,	continuous
	in current path,	continuous
		1 s
Dynamic overload capability (half cycle)		$250 \times I_N$
Power consumption,	voltage inputs	Approx. 0.5 VA
	current inputs	at $I_N = 1$ A at $I_N = 5$ A
		Approx. 0.1 VA Approx. 0.2 VA

Voltage supply

via integrated DC/DC converter

Rated auxiliary voltage V_{aux} / permissible tolerance	24, 48 V DC / 19 to 56 V DC 60, 110, 125 V DC / 48 to 144 V DC 220, 250 V DC / 176 to 288 V DC	
Max. ripple at rated voltage	$\leq 12\%$	
Power consumption,	quiescent	Approx. 12 W
	energized	Approx. 23 W
Max. back-up time during loss of auxiliary voltage	≥ 50 ms for $V_{aux} \geq 110$ V DC	

Binary inputs

Number	11, for each switching device 1 pair permanently assigned, the rest freely assignable
Voltage range	24 to 250 V DC
Current consumption independent of operating voltage	Approx. 2.5 mA

Alarm/event contacts

Number of relays with 1 C/O contact each	4 (marshallable)
Alarm/event relay with C/O contact	1
Switching capacity make/break	20 W/ VA
Switching voltage	250 V AC/DC
Permissible current, continuous	1 A

Command contacts

Number of relays	with 1 NO contact each	2 (marshallable)
	with 2 NO contacts each	2 (marshallable)
Switching capacity	make	1 000 W/ VA
	break	30 W/ VA
Switching voltage		250 V AC/DC
Permissible current	continuous	5 A
	0.5 s	30 A

LEDs

Ready indication green	1
Fault indication red	1
Marshallable LEDs red	6

Serial interfaces

Operator interface connection	non-isolated, on front panel
baud rate	9-way sub connector 1 200 to 19 200 Bd
Potential-free interface for connection to a control centre	
standard	Protocol to DIN 19 244
baud rate	4 800 to 19 200 Bd
fibre-optic connection	integrated FSMA connector for connection to fibre-optic cables at rear side
optical wavelength	820 nm
permissible attenuation	Max. 8 db
distance	Max. 1.5 km
no character	Switchable, supplied "light off"

Unit design

Housing, dimensions	7XP20, see dimension drawings
Weight flush mounting/cubicle mounting	Approx. 9.5 kg
Degree of protection according to EN 60529	IP 51

Standards

DIN VDE 0435, Part 303 and IEC 255-5 or IEC 255-6	–
---------------------------------------------------	---

Insulation tests

High-voltage test	2 kV (rms), 50 Hz; 1 min or alternatively 2.8 kV DC; 1 min
Impulse voltage test	5 kV (peak); 1.2/50 μ s; 0.5 J; 3 positive and 3 negative shots in intervals of 5 s

Disturbance tests

High-frequency test (1MHz test) IEC 255-22-1, class III	2.5 kV (peak); 1 MHz; $\tau = 15 \mu\text{s}$, 400 shots per second; duration 2 s
Electrostatic discharge (ESD test) IEC 255-22-2, class III	8 kV (peak); 5/30 ns; 10 positive discharges
Electromagnetic fields (Radiated electr. magn. field test) IEC 255-22-3, class III	Frequency 27 to 500 MHz; 10 V/m
Fast transient test IEC 255-22-4, class III	2 kV (peak); 5/50 ns; 5 kHz; 4 mJ per impulse; 1 min per polarity

EMC tests, emission (type tests) Standard: 50081-□ (generic standard)

Conducted interference voltage, aux. voltage CISPR 22, EN 55022, DIN VDE 0878 Part 22	150 kHz to 30 MHz limit value class B
Interference field strength CISPR 11, EN 55011, DIN VDE 0875 Part 11	30 to 1000 MHz limit value class A

Climatic conditions

Permissible ambient temperature	in service during storage during transport	-5 to +55 °C -25 to +55 °C -25 to +55 °C
Humidity rating		Annual average $\leq 75\%$ relative humidity, on 30 days per year up to 95 % relative humidity; condensation not permissible

Mechanical stress tests IEC 68 Parts 2 - 6 IEC 255 Part 21, 1

Permissible mechanical stress	in service during transport	10 to 60 Hz: 0.035 mm amplitude 60 to 500 Hz: 0.5 g acceleration 5 to 8 Hz: 7.5 mm amplitude 8 to 500 Hz: 2 g acceleration
-------------------------------	------------------------------------	-------------------------------------------------------------------------------------------------------------------------------------

Definite-time overcurrent protection non-directional/directional

Overcurrent	phase $I_{>}$ / phase $I_{\text{dir.}>}$ earth $I_{E>}$ / earth $I_{E \text{ dir.}>}$	$I/I_N = 0.1$ to 25, infinity $I/I_N = 0.05$ to 25, infinity
High-set current	phase $I_{>>}$ / phase $I_{\text{dir.}>>}$ earth $I_{E>>}$ / earth $I_{E \text{ dir.}>>}$	$I/I_N = 0.1$ to 25 $I/I_N = 0.05$ to 25
Delay times		0 to 60 s or infinity
Tolerances		
Current pick-up value		$\pm 5\%$ of set value
Time		$\pm 1\%$ or ± 10 ms
Reset time		Approx. 30 ms

Inverse-time overcurrent protection non-directional/directional

Overcurrent	phase I_p / phase $I_{p \text{ dir.}>}$ earth I_{Ep} / earth $I_{Ep \text{ dir.}>}$	$I_p/I_N = 0.1$ to 4 / $I_{p \text{ dir.}}/I_N = 0.1$ to 4 $I_{Ep}/I_N = 0.05$ to 4 / $I_{Ep \text{ dir.}}/I_N = 0.05$ to 4
High-set current	phase $I_{>>}$ (definite time, ANSI 51) / phase $I_{\text{dir.}>>}$ (definite time, ANSI 51) / earth $I_{E>>}$ (definite time, ANSI 51) / earth $I_{E \text{ dir.}>>}$ (definite time, ANSI 51)	$I/I_N = 0.1$ to 25 $I/I_N = 0.05$ to 25
Time multiplier t_p		0.05 to 3.2 s and infinity
Pick-up value		$1.1 \times I_p$
Characteristics according to IEC 255-4, Section 3.5.2 or BS 142 and ANSI C37		Normal inverse, very inverse, extremely inverse, $I/I_p = 1$ to 20, definite time char- acteristic above $20 \times I_p$
Tolerances		
Pick-up values $I_{>>}$, $I_{E>>}$, I_p , I_{Ep}		3 % of setting value
Delay time for $2 \leq I/I_p \leq 20$		5 % of setting value additionally 2 % current tolerance or 30 ms

Overvoltage protection

Overvoltage $V_{>}$	40 to 130 V
Delay time $t_{U>}$	0 to 60 s and infinity
Tolerances	
Voltage thresholds	3 % of set value
Delay times	1 % or 10 ms

Undervoltage protection

Undervoltage $V_{<}$ $V_{<<}$	30 to 120 V 30 to 120 V
Reset ratio r	1.05 to 3
Delay time $t_{U<}$ $t_{U<<}$	0 to 60 s and infinity 0 to 60 s and infinity
Tolerances	
Voltage thresholds	3 % of set value
Delay times	1 % or 10 ms

SIPROTEC 7SJ531 (Version V3.2)

Numerical Line and Motor Protection with Control Functions

Technical data (continued)

Overload protection	Factor k	0.1 to 4
	Time constant τ	1 to 999.9 min
	Alarm temperature θ_{Alarm}	50 to 100 %
	Current alarm stage I_{Alarm}	0,1 to $4 \times I_N$
	Prolongation factor at stand-still referring to time constant with running engine, factor τ	1 to 10
	Tolerances	
	Referring to $k \cdot I_N$	5 % class index acc. to IEC 255-8
	Referring to trip time	5 % ± 2 s; class index acc. to IEC 255-8
Auto-reclose function	Number of possible auto-reclosures, 3-pole	1 rapid auto-reclosure up to 9 delayed auto-reclosures
	Program for phase faults Initiation possible with	High-set O/Current $I_{>>}$ Overcurrent DMT $I_{>}$, IDMT I_p directional stages, unbalanced-load protection
	Program for earth faults Initiation possible with	High-set E/F $I_{E>>}$ Overcurrent DMT $I_{E>}$, IDMT I_{Ep} directional stages, unbalanced-load protection
	Action times	0.01 to 320 s and ∞
	Dead time RAR	0.01 to 320 s
	Dead times DAR	0.01 to 1 800 s
	Reclaim time	0.5 to 320 s
	Blocking times	0.5 to 320 s and ∞
	Close command duration	0.01 to 32 s
Earth-fault protection	Earth-fault detection with displacement voltage $V_{E>}$	2 to 130 V
	Faulted phase indication (only with directional option)	
	$V_{PHE} <$ the faulted phase	10 to 100 V
	$V_{PHE} >$ the healthy phase	10 to 100 V
	Measuring tolerance according to VDE 0435 part 303 (for sinusoidal quantities)	≤ 5 % of set value
	Directional determination	
	Measuring principle	Active/reactive power calculation
	Earth-fault current $I_{EE} > I_{EEP}$ (active and reactive)	3 to 1 600 mA
	Angle correction for core balance current transformer	0 to 5° in 2 CT operating points
	Adjustment of directional characteristic	- 45 to +45°
	Measuring tolerance according to VDE 0435 part 303 (for sinusoidal quantities)	≤ 10 % of set value
Circuit-breaker failure protection	Triggering threshold $I_{>}$	0.04 to $1 \times I_N$
	Delay time $t_{\text{breaker-failure protection}}$	0.06 to 60 s or infinity
	Tolerances	
	Pick-up value	3 % of setting value
	Delay time t	1 % of setting value or 20 ms
Unbalanced-load protection	Setting range	
	Tripping stage $I_{2>}$, $I_{2>>}$ in steps of 1%	5 to 80 % of I_N
	Time delays $T(I_{2>})$, $T(I_{2>>})$ in steps of 0.01 s	0 to 60 s
	Lower function limit	at least one phase current $\geq 0,1 \times I_N$
	Higher function limit	all phase currents $\leq 4 \times I_N$
	Tolerances	
	Pick-up values $I_{2>}$, $I_{2>>}$ current $I/I_N \leq 1.5$	± 1 % of I_N ± 5 % of set value
	current $I/I_N > 1.5$	± 5 % of I_N ± 5 % of set value
	Stage delay times $T(I_{2>})$, $T(I_{2>>})$	± 1 % or 10 ms
Starting time monitoring for motors	Setting ranges	
	Start-up current of the motor I_{start}/I_N	1 to 16
	Pick-up threshold $I_{\text{start en.}}/I_N$	0.6 to 10
	Permissible start-up time $T_{\text{start max.}}$	1 to 180 s
	Permissible locked-rotor time $T_{\text{lock. rot.}}$	0.5 to 120 s or ∞
	Tolerances	
	Pick-up value	3 %
	Delay time t	5 % of setting value or 30 ms

Start inhibit
for motors

Setting ranges	
Start-up current referred to rated motor current I_A/I_B	3 to 10
Rated motor current, rated transformer current I_B/I_N	0.2 to 1.2
Max. permissible start-up time $T_{start, max.}$	3 to 120 s
Rotor temperatur-delay time T_{delay}	0 to 60 min
Max. permissible hot starts n_h	1 to 4
Difference between hot and cold starts $n_c - n_h$	1 to 2
Prolongation factor for time constant of rotor; stand still $k_{\tau L}$	1 to 10

Fault location

Output of fault distance in km or mile line length	in Ω secondary,
Start-to-measure command	by trip signal or drop-off of fault detection or by external command via binary input
Setting reactance per unit line length (secondary)	0.01 to 10 Ω /miles, 0.006 to 6.215 Ω /km
Measuring tolerances acc. to VDE 0435 part 303 sinusoidal quantities	$\leq 2,5$ % of line length (without intermediate infeed) $30^\circ \leq \phi_K \leq 90^\circ$ and $V_{sc}/V_N \geq 0.1$

Fault recording

Measured values	$i_{L1}, i_{L2}, i_{L3}, i_E, v_{L1}, v_{L2}, v_{L3}, v_E$
Start signal	Trip, fault detection, binary input, LSA/SCADA, integrated operating panel
Recording duration	Max. 5 s
Holding time	Until fault-recording buffer full. New fault entries overwrite the oldest recorded faults.

Operational measured values

Currents	$I_{L1}, I_{L2}, I_{L3}, I_E$
Voltages	$V_{L1}, V_{L2}, V_{L3}, V_{12}, V_{23}, V_{13}, V_0$
Powers	P, Q
Power factor	$\cos \phi$
Energies	$W_{p+}, W_{p-}, W_{q+}, W_{q-}$
Frequency	f
Thermal replica	Θ, Θ_R
Measuring ranges	0 to 240 % I_N 0 to 120 % V_N P, Q are represented if all voltages and currents are within the valid range.

CE-conformity, standards

This product is in conformity with the directives of the Council of the European Communities on the approximation of the laws of the Member States relating to the electromagnetic compatibility (EMC Council Directive 89/336/EEC) and concerning electrical equipment for use within specified voltage limits (low-voltage directive 73/23/EEC). The product conforms with the international standard IEC 255 and the national standard DIN 57 435 part 303.

The relay is designed for use in an industrial environment acc. to the EMC standard specification.

Conformity is proved by tests performed by Siemens AG in line with article 10 of the Council Directives in accordance with the generic standards EN 50081-2 and EN 50082-2 for the low-voltage directive.

SIPROTEC 7SJ531 (Version V3.2)

Numerical Line and Motor Protection with Control Functions

Selection and ordering data

Designation	Order No.
SIPROTEC 7SJ531 (Version V3.2)	7SJ531 <input type="checkbox"/> - <input type="checkbox"/> <input type="checkbox"/> A <input type="checkbox"/> 2 - <input type="checkbox"/> <input type="checkbox"/> A <input type="checkbox"/>
Numerical line and motor protection with control functions	
<u>Rated current at 50/60 Hz</u> 1 A 5 A	1 5
<u>Auxiliary voltage V_{aux} for integrated DC/DC converter</u> 24, 48 V DC 60, 110, 125 V DC 220, 250 V DC	2 4 5
<u>Construction</u> Housing 7XP2030-1 for panel surface mounting without glass cover Housing 7XP2030-2 for panel flush mounting/cubicle mounting with Weidmüller terminals without glass cover	B E
<u>Languages</u> German/English German/French German/Polish	0 1 2
<u>Function range</u> with wattmetric earth-fault detection, with auto-reclose with wattmetric earth-fault detection, without auto-reclose without wattmetric earth-fault detection, with auto-reclose without wattmetric earth-fault detection, without auto-reclose	0 1 2 3
<u>Serial system interface</u> without serial system interface with serial 820 nm fibre-optic module (FSMA connector)	A C
<u>Directional overcurrent-time protection</u> without with	0 1
Manual 7SJ531 German English French Polish	C53000 - G1100 - C114-1 - G1176 - C114-1 - G1177 - C114-1 - G1155 - C114-1
DIGSI (Operating and analysis software for numerical protection devices)	7XS5020 - <input type="checkbox"/> AA00
<u>Operating languages</u> German English French	0 1 2

Connection diagram

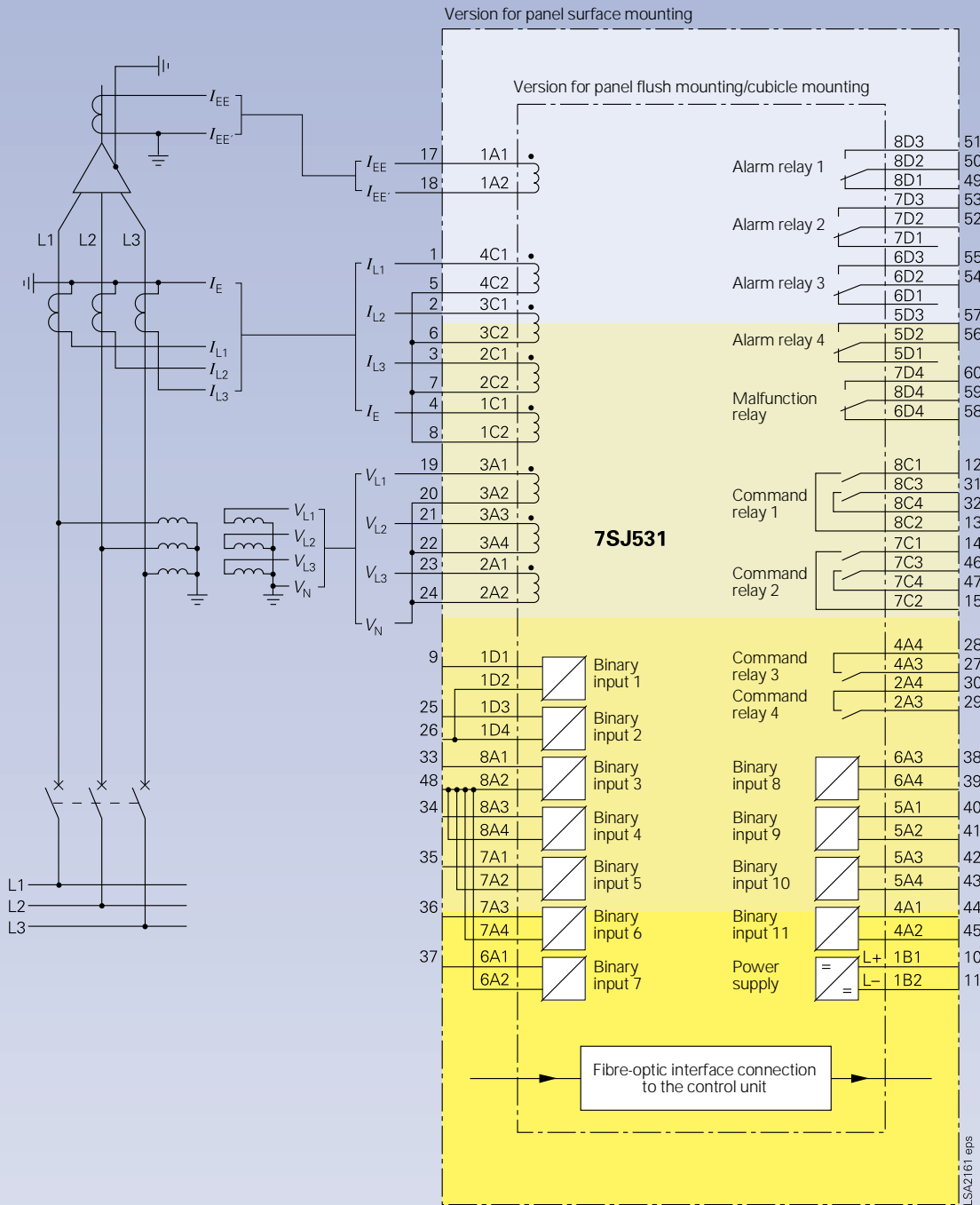

Fig. 33
Connection diagram

SIPROTEC 7SJ531 (Version V3.2)

Numerical Line and Motor Protection with Control Functions

Dimension drawings (in mm)

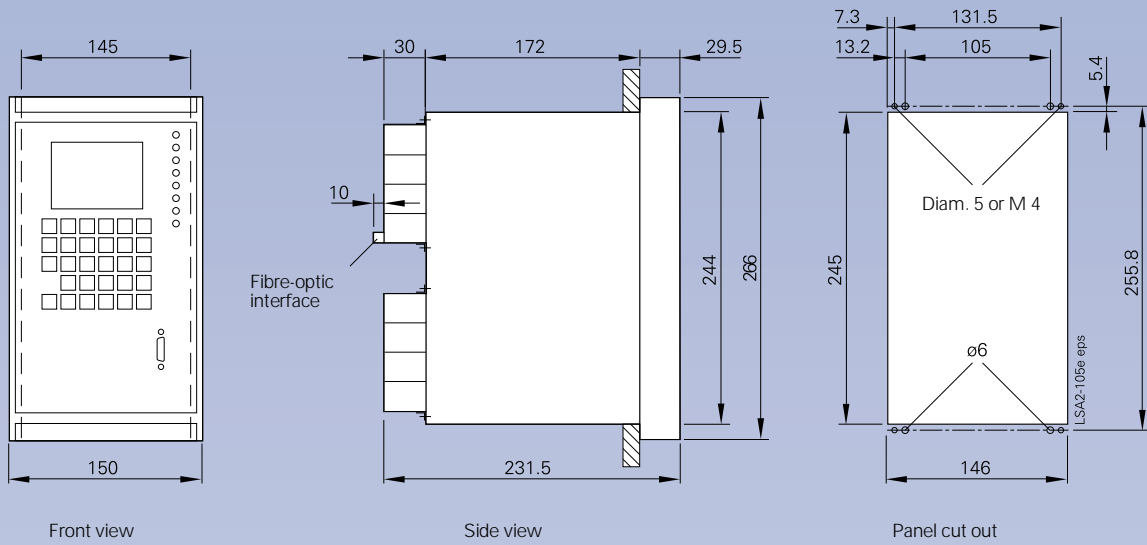

Fig. 34
7SJ531 with 7XP2030-2 housing
for panel flush mounting/cubicle mounting

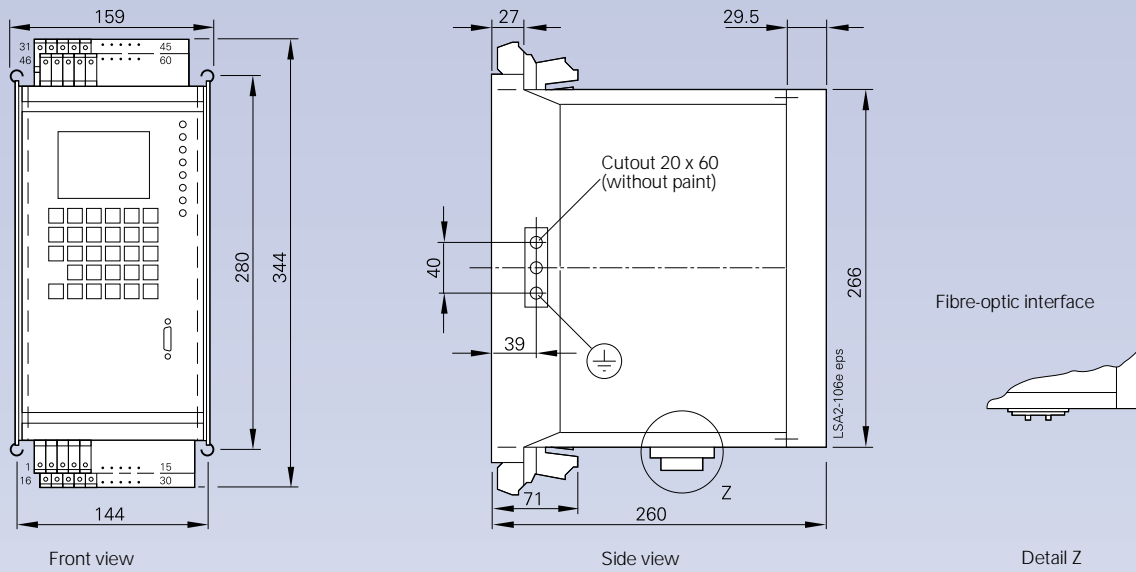

Fig. 35
7SJ531 with 7XP2030-1 housing
for panel surface mounting with two-tier terminals

Technical specification

The protective relays measured value processing must be completely numerical, i.e. all the way from sampling and digitizing of the analog values up to the decision to trip the circuit-breaker. The protective device must feature complete galvanic and interference-free isolation of the internal processing circuits from the measuring and supply circuits of the system by means of shielded input, binary I/O modules and DC converters.

It must be possible to apply the combined protection, control and monitoring device in networks with different types of neutral point earthing. Control of the switchgear must take place via the integrated operator panel, via binary inputs or via an operating and analysis program. Telecontrol of the protective device via modem must be possible.

The motor protection functions must be suitable for asynchronous machines of all sizes. Both overvoltage and undervoltage protection functions for the motor must be available. The undervoltage protection should have two stages. The starting time monitoring must take account of various starting currents. It must be possible to connect an external speed monitor to the protective device, in order to identify a locked rotor and to issue a non-delayed trip.

The overcurrent-time protection must be either definite-time or inverse-time, separately selectable for phase and earth faults. It must be possible to select from available characteristic curves (acc. to ANSI/IEEE and IEC) as well as from an user-defined overcurrent-time characteristic. The inverse-time overcurrent protection should be able to evaluate either the fundamental current or the true rms value.

It must be possible to connect a core-balance current transformer for sensitive earth-fault detection. The phase and earth-fault characteristics must be directional. It must be possible to rotate the tripping characteristic of the wattmetric earth-fault detection for particular network conditions. A fault locator should indicate the distance to the fault location. Automatic reclosure should permit a number of reclosing operations.

The operational measured values should include metered values for active and reactive work done and operating hour count. It should be possible to check individual operational measured values against set limits. It should be possible to select specific measured values for indication in the graphic display. The active and reactive power should be provided for the LSA/SCADA.

The internal battery should be checked at regular intervals by the processor. If battery capacity drops, an alarm should be initiated.

Catalog Index of the Protection and Substation Control

Title	Designation	Order No.
Measurement and Recording Systems		
Fault Recorder OSCILLOSTORE	SR 10.1	E50001-K4010-A101-A1-7600
Protective Relaying		
7SJ41 Definite-Time Overcurrent Protection Relay	LSA 2.1.10	E50001-K5712-A201-A2-7600
7SJ511 Numerical Overcurrent-Time Protection (Version V3)	LSA 2.1.3	E50001-K5712-A131-A3-7600
7SJ512 Numerical Overcurrent-Time Protection (Version V3)	LSA 2.1.4	E50001-K5712-A141-A3-7600
7SJ512 Numerical Feeder Protection	LSA 2.1.30	E50001-K5712-A411-A1-7600
7SJ531 SIPROTEC Numerical Overcurrent Protection Relay	LSA 2.1.9	E50001-K5712-A191-A4-7600
7SJ551 Multi-Function Protection Relay	LSA 2.4.2	E50001-K5742-A121-A3-7600
7SJ600 SIPROTEC Overcurrent, Motor and Overload Protection	LSA 2.1.15	E50001-K5712-A251-A2-7600
7SJ601 SIPROTEC Overcurrent Protection	LSA 2.1.16	E50001-K5712-A261-A1-7600
7SA510 Distance Protection Relay (Version V3)	LSA 2.1.17	E50001-K5712-A271-A1-7600
7SA511 Line Protection Relay (Version V3)	LSA 2.1.11	E50001-K5712-A211-A2-7600
7SA513 Line Protection Relay (Version V3)	LSA 2.1.12	E50001-K5712-A221-A1-7600
7SA518/519 Overhead Control-Line Protection Relay (Version V3)	LSA 2.1.14	E50001-K5712-A241-A1-7600
3VU13 Miniature Circuit-Breaker	LSA 2.1.8	E50001-K5712-A181-A2-7600
7SD502 Line Differential Protection with Two Pilot Wires	LSA 2.2.1	E50001-K5722-A111-A2-7600
7SD503 Line Differential Protection with Three Pilot Wires	LSA 2.2.2	E50001-K5722-A121-A2-7600
7SD511/512 Current Comparison Protection Relay (Version V3) for Overhead Lines and Cables	LSA 2.2.3	E50001-K5722-A131-A2-7600
7UT512/513 Differential Protection Relay (Version V3) for Transformers, Generators and Motors	LSA 2.2.4	E50001-K5722-A141-A2-7600
7SS5 Station Protection	LSA 2.2.5	E50001-K5722-A151-A2-7600
Auxiliary Current Transformers 4AM50, 4AM51, 4AM52 and Isolating Transformers 7XR95	LSA 2.2.6	E50001-K5722-A161-A1-7600
7SN71 Transient Earth-Fault Relay	LSA 2.3.2	E50001-K5732-A121-A1-7600
7VC1637 Earth-Leakage Monitor	LSA 2.3.4	E50001-K5732-A141-A1-7600
7UM511 Generator Protection Relay (Version V3)	LSA 2.5.2	E50001-K5752-A121-A2-7600
7UM512 Generator Protection Relay (Version V3)	LSA 2.5.3	E50001-K5752-A131-A2-7600
7UM515 Generator Protection Relay (Version V3)	LSA 2.5.4	E50001-K5752-A141-A2-7600
7VE51 Synchronizing Unit	LSA 2.5.7	E50001-K5752-A171-A1-7600
7VK512 Numerical Auto-Reclose/Check-Synchronism Relay	LSA 2.7.3	E50001-K5772-A131-A1-7600
Test Switch 7XV72	LSA 2.7.8	E50001-K5772-A181-A1-7600
7VP151 Three-Phase Portable Test Set (Omicron CMC56)	LSA 2.6.1	E50001-K5762-A111-A2-7600
Centralized and Remote Control of Siemens Protection Relays (Overview)*	LSA 2.8.1	E50001-K5782-A111-A1-7600
Operating and Analysis Software DIGSI V3*	LSA 2.8.2	E50001-K5782-A121-A1-7600
Substation Control and Protection		
Input/Output Unit 6MB522	LSA 1.1.1	E50001-K5701-A111-A4-7600
Input/Output Unit 6MB523	LSA 1.1.2	E50001-K5701-A121-A2-7600
6MB511/6MB512 Substation Master Unit 7SW511/7SW512 Relay Data Concentrator	LSA 1.1.3	E50001-K5701-A131-A2-7600
6MB520/6MB521 Input/Output Units	LSA 1.1.4	E50001-K5701-A141-A1-7600
6MB513/514 Compact Control Master Unit and Relay Data Concentrator	LSA 1.1.6	E50001-K5701-A161-A1-7600
6MB5510 Station Control Unit	LSA 1.2.1	E50001-K5701-A211-A2-7600
6MB552 Compact Remote Terminal Unit	LSA 1.2.2	E50001-K5701-A221-A1-7600
6MB5530-0 Minicomcompact Remote Terminal Unit	LSA 1.2.3	E50001-K5701-A231-A1-7600
6MB5530-1 Minicomcompact Remote Terminal Unit for Cable Shield Communication	LSA 1.2.4	E50001-K5701-A241-A1-7600
6MB5540 SINAUT LSA COMPACT Remote Terminal Unit	LSA 1.2.5	E50001-K5701-A251-A1-7600
6MB5515 Station Control Unit	LSA 1.2.6	E50001-K5701-A261-A1-7600
Control in SINAUT LSA Substation Control and Protection	LSA 1.4.1	E50001-K5701-A411-A1-7600
Status Indications in SINAUT LSA Substation Control and Protection	LSA 1.4.2	E50001-K5701-A421-A1-7600
Analog Values in SINAUT LSA Substation Control and Protection	LSA 1.4.3	E50001-K5701-A431-A1-7600
Metering in SINAUT LSA Substation Control and Protection	LSA 1.4.4	E50001-K5701-A441-A1-7600
Voltage Control with Input/Output Units 6MB520/6MB521	LSA 1.4.5	E50001-K5701-A451-A1-7600
Network Synchronization with Input/Output Units 6MB520/521	LSA 1.4.6	E50001-K5701-A461-A1-7600
Operation with Two Control Master Units	LSA 1.4.7	E50001-K5701-A471-A1-7600
Node Functions in SINAUT LSA Substation Control and Protection	LSA 1.4.8	E50001-K5701-A481-A1-7600
System Management with the SINAUT LSA Substation Control and Protection System	LSA 1.4.9	E50001-K5701-A491-A1-7600
LSADIAG - Testing and Diagnostics System for SINAUT LSA Substation Control and Protection	LSA 1.5.2	E50001-K5701-A521-A1-7600
LSACONTROL - Control and Monitoring	LSA 1.5.3	E50001-K5701-A531-A1-7600
LSAPROCESS - Process Information Analysis	LSA 1.5.5	E50001-K5701-A551-A1-7600
LSA 678 Standard Cubicle	LSA 1.6.1	E50001-K5701-A611-A1-7600

* Information on additional equipment for 7SJ531

Conditions of Sale and Delivery · Export Regulations Trademarks · Dimensions

Conditions of Sale and Delivery

Subject to the General Conditions of Supply and Delivery for Products and Services of the Electrical and Electronic Industry and to any other conditions agreed upon with the recipients of catalogs.

■ The technical data, dimensions and weights are subject to change unless otherwise stated on the individual pages of this catalog.

The illustrations are for reference only.

We reserve the right to adjust the prices and shall charge the price applying on the date of delivery. En 1.91a

Export Regulations

In accordance with the present provisions of the German Export List and the US Commercial Control List, export licences are not required for the products listed in this catalog.

An export licence may however be required due to country-specific application and final destination of the products.

Relevant are the export criteria stated in the delivery note and the invoice regarding a possible export and reexport licence.

Subject to change without notice.

Trademarks

All product designations used are trademarks or product names of Siemens AG or of other suppliers.

Dimensions

All dimensions in this catalog are given in mm.

Siemens online!

The Power Transmission and Distribution Group can also be found in the Internet:

<http://www.ev.siemens.de>

Responsible for

Technical contents:

Hans Heining-Triebs, Marko Zaherdoust,
Siemens AG, EV S V13, Nürnberg

General editing: Claudia Kühn-Sutiono
Siemens AG, EV BK T, Erlangen

Bereich
Energieübertragung und -verteilung
Geschäftsgebiet Sekundärssysteme
Postfach 4806
D-90026 Nürnberg

Siemens Aktiengesellschaft

Power
to the Point

Order No.: E50001-K5712-A191-A4-7600