

# Pocket Modem 56k 3.1

---





Copyright © August 11 INSYS MICROELECTRONICS GmbH

Any duplication of this manual is prohibited. All rights on this documentation and the devices are with INSYS MICROELECTRONICS GmbH Regensburg.

#### Trademarks

The use of a trademark not shown below is not an indication that it is freely available for use.

MNP is a registered trademark of Microcom Inc.

IBM PC, AT, XT are registered trademarks of International Business Machine Corporation.

INSYS®, e-Mobility LSG® and e-Mobility PLC® are registered trademarks of INSYS MICROELECTRONICS GmbH.

Windows™ is a registered trademark of Microsoft Corporation.

Linux is a registered trademark of Linus Torvalds.

#### Publisher:

INSYS MICROELECTRONICS GmbH

Waffnergasse 8

D-93047 Regensburg, Germany

Phone: +49 (0)941/56 00 61

Fax: +49 (0)941/56 34 71

E-mail: [insys@insys-tec.de](mailto:insys@insys-tec.de)

Internet: <http://www.insys-icom.com>

Date: Aug-11

Item: 31-22-06.019

Version: 1.1

Language: EN

<b>1</b>	<b>Preface</b> .....	<b>6</b>
1.1	Defects Liability Terms .....	6
1.2	Marking of Warnings and Notes.....	7
1.2.1	Symbols and Key Words .....	7
1.3	Symbols and the Formatting in this Manual .....	8
<b>2</b>	<b>Safety</b> .....	<b>9</b>
2.1	Usage According to the Regulations .....	9
2.2	Permissible Technical Limits.....	10
2.3	Responsibilities of the Operator.....	10
2.4	Qualification of the Personnel.....	10
2.5	Instructions for Transport and Storage .....	10
2.6	Markings on the Product .....	11
2.7	Environmental Protection .....	11
2.8	Safety Instructions for Electrical Installation .....	12
2.9	General Safety Instructions.....	12
<b>3</b>	<b>Scope of Delivery</b> .....	<b>14</b>
<b>4</b>	<b>Technical Data</b> .....	<b>15</b>
4.1	Physical Features.....	15
4.2	Technological Features .....	15
4.3	Certifications.....	15
<b>5</b>	<b>Connections and LEDs</b> .....	<b>16</b>
5.1	Front.....	16
5.2	Back.....	17
5.3	Pin Layout of the Serial Interface.....	17
5.4	RJ12 Phone Connection .....	18
<b>6</b>	<b>Function Overview</b> .....	<b>19</b>
<b>7</b>	<b>Initial Operation</b> .....	<b>21</b>
<b>8</b>	<b>Operating Principle</b> .....	<b>23</b>
8.1	Operation with the Terminal Program.....	23
<b>9</b>	<b>Functions</b> .....	<b>25</b>
9.1	Establish or Accept a Data Connection.....	25
9.2	Select Country-Specific Presets .....	27
9.3	Automatic Baud Rate Detection .....	27
9.3.1	Serial Connection .....	27
9.3.2	Phone connection .....	28
9.4	Data Buffer for Serial Data Transmission .....	29
9.5	Bit Direct Mode .....	29

---

9.6	Data Flow Control (Handshake) .....	30
9.6.1	Hardware data flow control (RTS/CTS) .....	30
9.6.2	Software data flow control (XON/XOFF) .....	30
9.7	Error correction.....	31
9.8	Data Compression .....	32
9.9	Selective Call Acceptance.....	33
9.10	Sending messages via data connection, SMS or Fax .....	35
9.11	Manual Sending of Messages.....	36
9.12	Switching on the Remote Configuration.....	37
9.13	Remote Configuration of the Pocket Modem 56k 3.1.....	38
9.14	Access Control and Security Callback .....	39
9.15	Idle Connection Control with Data Transmit Control .....	42
9.16	Priority Circuit for a Phone Connected in Series to the Pocket Modem 56k 3.1 ..	42
9.17	Reset .....	45
9.18	Firmware Update .....	46
10	Maintenance, Repair and Troubleshooting.....	48
10.1	Maintenance.....	48
10.2	Troubleshooting.....	48
10.3	Repair .....	48
11	Waste Disposal .....	49
11.1	Repurchasing of Legacy Systems.....	49
12	Declaration of Conformity .....	50
13	AT Command Reference .....	51
13.1	AT Messages .....	76
14	Country Codes .....	79
15	S Registry .....	83
15.1	Overview S Registry .....	83
15.2	Description S Registry .....	85
16	SMS Provider / Service Center .....	94
16.1	Alarm via SMS.....	94
16.2	Alarm Using E-Mail via SMS.....	94
17	Tables and Diagrams.....	96
17.1	List of Tables .....	96
17.2	List of Diagrams .....	96
18	Index.....	97

# 1 Preface

This manual allows for the safe and efficient use of the product. The manual is part of the product and must always be stored accessible for installation, commissioning and operating personnel.

## 1.1 Defects Liability Terms

A usage not according to the intended purpose, an ignorance of this documentation, the use of insufficiently qualified personnel as well as unauthorised modifications exclude the liability of the manufacturer for damages resulting from this. The liability of the manufacturer ceases to exist.

The regulations of our Delivery and Purchasing Conditions are effective. These can be found on our website ([www.insys-icom.de/imprint/](http://www.insys-icom.de/imprint/)) under "General Terms and Conditions".

## 1.2 Marking of Warnings and Notes

### 1.2.1 Symbols and Key Words

#### **Danger!**



##### **Risk of severe or fatal injury**

One of these symbols in conjunction with the key word Danger indicates an imminent danger. It will cause death or severe injuries if not avoided.



#### **Warning!**



##### **Personal injury**

This symbol in conjunction with the key word Warning indicates a possibly hazardous situation. It might cause death or severe injuries if not avoided.

#### **Caution!**



##### **Slight injury and / or material damage**

This symbol in conjunction with the key word Caution indicates a possibly hazardous or harmful situation. It might cause slight or minor injuries or a damage of the product or something in its vicinity if not avoided.

#### **Note**

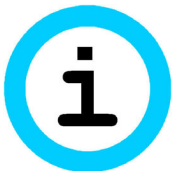

##### **Improvement of the application**

This symbol in conjunction with the key word Note indicates hints for the user or very useful information. This information helps with installation, set-up and operation of the product to ensure a fault-free operation.

## 1.3 Symbols and the Formatting in this Manual

This section describes the definition, formatting and symbols used in this manual. The various symbols are meant to help you read and find the information relevant to you. The following text is structured like a typical operating instruction of this manual.

### **Bold print: This will tell you what the following steps will result in**

After that, there will be a detailed explanation why you could perform the following steps to be able to reach the objective indicated first. You can decide whether the section is relevant for you or not.

→ An arrow will indicate prerequisites which must be fulfilled to be able to process the subsequent steps in a meaningful way. You will also learn which software or which equipment you will need.

1. ***One individual action step: This tells you what you need to do at this point. The steps are numbered for better orientation.***

✓ A result which you will receive after performing a step will be marked with a check mark. At this point, you can check if the previous steps were successful.

ⓘ Additional information which you should consider are marked with a circled "i". At this point, we will indicate possible error sources and tell you how to avoid them.

➤ *Alternative results and steps are marked with an arrow. This will tell you how to reach the same results performing different steps, or what you could do if you didn't reach the expected results at this point.*



## 2 Safety

The Safety section provides an overview about the safety instructions, which must be observed for the operation of the product.

The product is constructed according to the currently valid state-of-the-art technology and reliable in operation. It has been checked and left the factory in flawless condition concerning safety. In order to maintain this condition during the service life, the instructions of the valid publications and certificates must be observed and followed.

It is necessary to adhere to the general safety instructions must when operating the product. The descriptions of processes and operation procedures are provided with precise safety instructions in the respective sections in addition to the general safety instructions.

Moreover, the local accident prevention regulations and general safety regulations for the operating conditions of the device are effective.

An optimum protection of the personnel and the environment from hazards as well as a safe and fault-free operation of the product is only possible if all safety instructions are observed.

### 2.1 Usage According to the Regulations

The product may only be used for the purposes specified in the function overview. In addition, it may be used for the following purposes:

- Data transmission functions in machines according to the machine directive 2006/42/EC.
- Usage as data transmission device for a PLC or a usual PC.

The product may not be used for the following purposes and used or operated under the following conditions:

- Controlling or switching of machines and systems, which do not comply with the directive 2006/42/EC.
- Usage, controlling, switching and data transmission of machines and systems, which are operated in explosive atmospheres.
- Controlling, switching and data transmission of machines, which may involve risks to life and limb due to their functions or when a breakdown occurs.

## 2.2 Permissible Technical Limits

The product is only intended for the use within the permissible technical limits specified in the data sheets.

The following permissible limits must be observed:

- The ambient temperature limits must not be fallen below or exceeded.
- The supply voltage range must not be fallen below or exceeded.
- The maximum humidity must not be exceeded and condensate formation must be prevented.
- The maximum switching voltage and the maximum switching current load must not be exceeded.
- The maximum input voltage and the maximum input current must not be exceeded.

## 2.3 Responsibilities of the Operator

As a matter of principle, the operator must observe the legal regulations, which are valid in his country, concerning operation, functional test, repair and maintenance of electrical devices.

## 2.4 Qualification of the Personnel

The installation, commissioning and maintenance of the product must only be performed by trained expert personnel, which has been authorised by the plant operator. The expert personnel must have read and understood this documentation and observe the instructions.

Electrical connection and commissioning must only be performed by a person, who is able to work on electrical installations and identify and avoid possible hazards independently, based on professional training, knowledge and experience as well as knowledge of the relevant standards and regulations.

## 2.5 Instructions for Transport and Storage

The following instructions must be observed:

- Do not expose the product to moisture and other potential hazardous environmental conditions (radiation, gases, etc.) during transport and storage. Pack product accordingly.
- Pack product sufficiently to protect it against shocks during transport and storage, e.g. using air-cushioned packing material.

Check product for possible damages, which might have been caused by improper transport, before installation. Transport damages must be noted down to the shipping documents. All claims or damages must be filed immediately and before installation against the carrier or party responsible for the storage.

## 2.6 Markings on the Product

The identification plate of the product is either a print or a label on a face of the product. Amongst other things, it contains the following markings, which are explained in detail here.



### Observe manual

This symbol indicates that the manual of the product contains essential safety instructions that must be followed implicitly.



### Dispose waste electronic equipment environmentally

This symbol indicates that waste electronic equipment must be disposed separately from residual waste via appropriate collecting points. See also Section Disposal in this manual.



### CE marking

By applying a CE marking, the manufacturer confirms that the product complies with the European directives that apply product-specific.



### Appliance Class II – double insulated

This symbol indicates that the product complies with Appliance Class II

## 2.7 Environmental Protection

Dispose the product and the packaging according to the relevant environmental protection regulations. The Waste Disposal section in this manual contains notes about disposing the product. Separate the packaging components of cardboard and paper as well as plastic and deliver them to the respective collection systems for recycling.

## 2.8 Safety Instructions for Electrical Installation

The electrical connection must only be made by authorised expert personnel according to the wiring diagrams.

The notes to the electrical connection in the manual must be observed. Otherwise, the protection category might be affected.

The safe disconnection of circuits, which are hazardous when touched, is only ensured if the connected devices meet the requirements of VDE T.101 (Basic requirements for safe disconnection).

The supply lines are to be routed apart from circuits, which are hazardous when touched, or isolated additionally for a safe disconnection.

## 2.9 General Safety Instructions

### Caution!



**Moisture and liquids from the environment may seep into the interior of the product!**

**Fire hazard and damage of the product.**

The product must not be used in wet or damp environments, or in the direct vicinity of water. Install the product at a dry location, protected from water spray. Disconnect the power supply before you perform any work on a device which may have been in contact with moisture.

### Caution!



**Short circuits and damage due to improper repairs and modifications as well as opening of maintenance areas.**

**Fire hazard and damage of the product.**

It is not permitted to open the product for repair or modification.

### Caution!



**Overcurrent of the device supply!**

**Fire hazard and damage of the product due to overcurrent.**

The product must be secured with a suitable fuse against currents exceeding 1.6 A.

**Caution!**

**Overvoltage and voltage peaks from the mains supply!**  
Fire hazard and damage of the product due to overvoltage.  
Install suitable overvoltage protection.

**Caution!**

**Damage due to chemicals!**  
Ketones and chlorinated hydrocarbons dissolve the plastic housing and damage the surface of the device.  
Never let the device come into contact with ketones (e.g. acetone) or chlorinated hydrocarbons, such as dichloromethane.

**Caution!**

**Damage of the product!**  
Wrong power supply unit.  
Use the Pocket Modem 56k 3.1 only with the supplied power supply unit. Using a different power supply unit may damage the Pocket Modem 56k 3.1. The manufacturer cannot assume liability for this.

### 3 Scope of Delivery

The scope of delivery for the Pocket Modem 56k 3.1 includes all accessories listed below. Please check if all accessories are included in the box. If a part is missing or damaged, please contact your distributor.

Please keep the packing material for a possible future dispatch or storage.

- Pocket Modem 56k 3.1
- Power supply unit 230 V AC to 9...10 V DC
- Cable:
  - 1 phone cord (TAE-N to RJ12)
  - 1 serial cable with 9-pin sub-D plug for the connection to the PC (RS-232)
- 1 manual
- 1 CD ROM (optional)

## 4 Technical Data

### 4.1 Physical Features

All specified data was measured with a nominal input voltage, at full load, and an ambient temperature of 25 °C. The threshold value tolerances are subject to typical fluctuations.

Physical Feature	Value
Operating voltage	9..10 V DC voltage
Power consumption	Approx. 140 mA
Weight	150 g
Dimensions (Width x Depth x Height)	71 mm x 128 mm x 22 mm
Temperature range	0 °C – 55 °C
Maximum allowed humidity	95 % non-condensing

Table 1: Physical Features

### 4.2 Technological Features

Technological Feature	Description
Protection Class	Housing IP40
Supported data compression standards	MNP 2/3, MNP 5, V.42 bis; V.44, MNP 10, MNP 10 EC
Fax-Classes	Fax Class 1/2
Modulation types	V.32bis, V.32, V.23, V.22, V22 bis, V21, V.34+, V.34, V.42, V.90, V.92, Bell Norm 103/212
Error correction standards	MNP4, LAPM

Tabelle 1: Technological Features

### 4.3 Certifications

The Pocket Modem 56k 3.1 has been developed according to the following guidelines and standards:

- R&TTE 1999/5/EC
- DIN EN 55022 Class B
- DIN EN 61000-6-2
- DIN EN 60950-1
- CTR 21

## 5 Connections and LEDs

### 5.1 Front

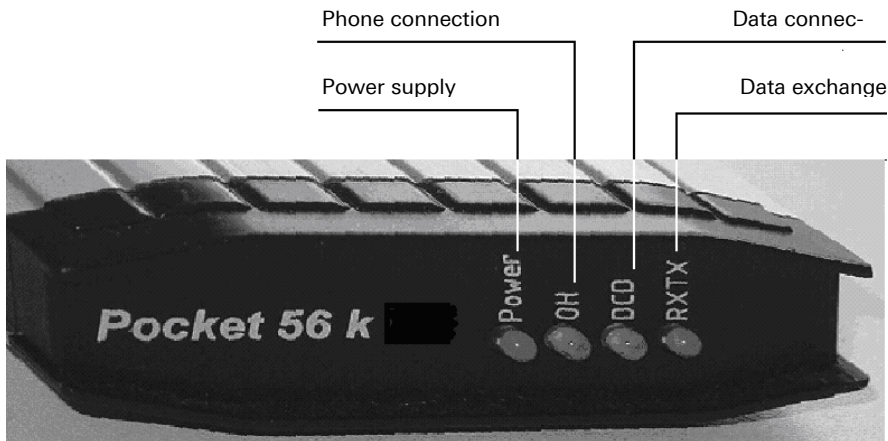

Figure 1: LEDs on the front

Description	Colour	LED off	LED on
Power	green	no power supply	power supply present
OH (Off Hook)	yellow	modem is offline	modem occupies phone line (online)
DCD (Data Carrier Detect)	Yellow	no connection established	connection to remote terminal established
RX/TX (Receive / Transmit)	green	no data exchange	data exchnage via the modem

Table 2: Description of the LEDs on the front



## 5.2 Back

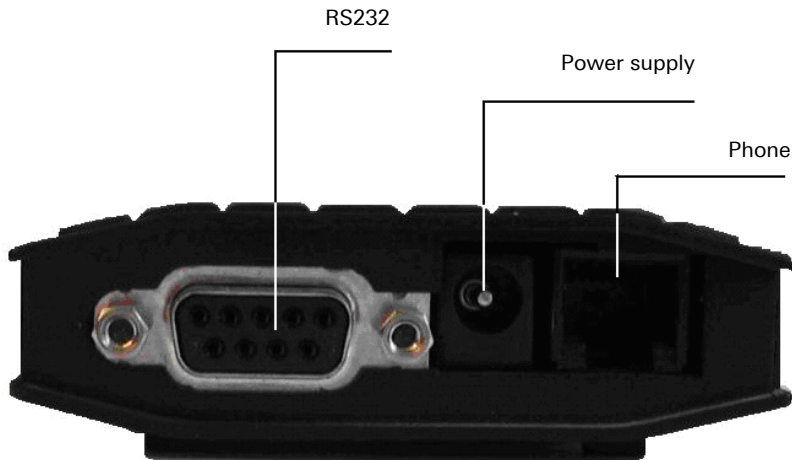

Figure 2: Connections on the back

## 5.3 Pin Layout of the Serial Interface

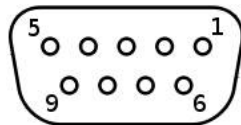

Figure 3: 9 pin D-sub socket at the device

Pin	Configuration	Description
1	DCD	Data Carrier Detect
2	RXD	Receive Data
3	TXD	Transmit Data
4	DTR	Data Terminal Ready
5	GND	Ground
6	DSR	Data Set Ready
7	RTS	Request To Send
8	CTS	Clear To Send
9	RI	Ring Indication

Table 3: Description of the pin layout of the D-sub socket

## 5.4 RJ12 Phone Connection

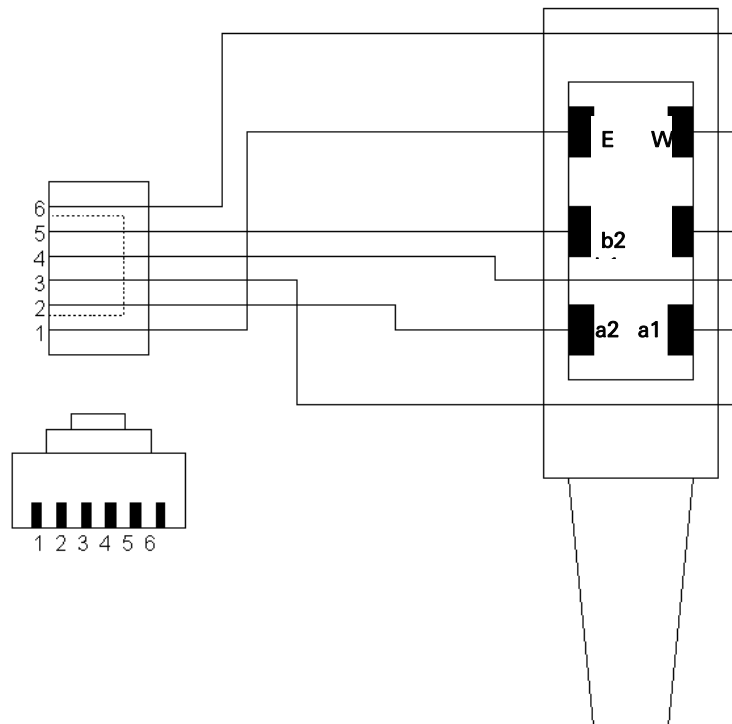

Figure 4: RJ12 plug connected with TAE connector

Pin	Configuration	Description
1	E	not connected (ground)
2	a2	for connecting a subsequent phone
3	a1	<b>Incoming</b> phone line (exchange line or PABX)
4	b1	<b>Outgoing</b> phone line (exchange line or PABX)
5	b2	for connecting a subsequent phone
6	W	not connected (external bell)

Table 4: Description of the pin layout of the RJ12 connector and the TAE connector

## 6 Function Overview

The Pocket Modem 56k 3.1 offers the following functions:

- **Automatic Baud Rate Detection**

The Pocket Modem 56k 3.1 will automatically adjust the data transmission rate, if a connection is made via its serial interface. The serial transmission rate can be preset for applications for the serial communication to be able to initialize with a defined baud rate.

- **Data buffer for serial data transmission**

The Pocket Modem 56k 3.1 has a fast send and receive buffer (cache) to adjust the modem to the operating speed of the application.

- **Bit Direct Mode**

The Pocket Modem 56k 3.1 can forward incoming data without having any influence on their transmission format.

- **Hardware and software data flow control**

The Pocket Modem 56k 3.1 can transmit to the application via the control lines of the serial interface to interrupt the dataflow, if the buffers of the Pocket Modem 56k 3.1 exceed a certain level. An application can also prompt the Pocket Modem 56k 3.1 via a control line to interrupt the data flow. As an alternative, the Pocket Modem 56k 3.1 can control the data flow via XOFF/XON characters in the data stream.

- **Error correction**

The Pocket Modem 56k 3.1 has the following error correction protocols: V.42,V.42bis, V.44,MNP2, MNP3, MNP4, and MNP10

- **Selective Call Answer**

The Pocket Modem 56k 3.1 can be set to accept only calls from phone numbers that were previously stored.

- **Sending messages via data connection, SMS or Fax**

The Pocket Modem 56k 3.1 can send a previously entered message to another modem, either as SMS or Fax, via a data connection. The message dispatch is triggered via an AT command.

- **Remote configuration**

The Pocket Modem 56k 3.1 can be configured remotely with the help of a common modem and a terminal program.

- **Access control**

The Pocket Modem 56k 3.1 can be protected from unauthorized access via a phone connection. An incoming connection must first be enabled with a password. Using security callback, the Pocket Modem 56k 3.1 calls a previously defined phone number back, when a call comes in.

- **Idle connection control with Data Transmit Control**

Data Transmit Control enables the Pocket Modem 56k 3.1 to terminate the connection, if no data is transmitted during a defined state. This will prevent unnecessary costs.

- **Priority circuit for phones connected in series to the Pocket Modem 56k 3.1**

The priority circuit prevents that a phone which is connected to the Pocket Modem 56k 3.1 in series is affected by the modem operation. The modem keeps the line free for phone operation. The Pocket Modem 56k 3.1 recognizes the states of the phone line at the individually adjustable voltages.

- **Storing the settings in the user profiles**

The Pocket Modem 56k 3.1 can store the user settings in two different "profiles". This means that two different configurations can be stored for special purposes and loaded as needed.

## 7 Initial Operation

This chapter describes how to activate the Pocket Modem 56k 3.1, i.e. how to connect the Pocket Modem 56k 3.1 to a PC, to a telephone network and how to test it.

### Connect the Pocket Modem 56k 3.1 to the power supply

How to connect the Pocket Modem 56k 3.1 to the power supply.

→ You will need the supplied power supply unit.

→ You will need a free power outlet.

1. *Connect the power supply connector of the supplied power supply unit into the Pocket Modem 56k 3.1.*
2. *Connect the power supply unit to the power outlet.*

✓ The Power LED is illuminated.

### Connect the Pocket Modem 56k 3.1 to a PC

How to connect the Pocket Modem 56k 3.1 to a PC via a serial interface.

→ You will need the 9 pin serial cable.

→ You will need a free serial interface at the PC.

ⓘ Use preferably serial interfaces which are actually at the PC as "real" hardware. Virtual serial interfaces or USB-to-Serial solutions often cause problems.

2. *Connect the 9 pin serial cable with the Pocket Modem 56k 3.1 and fasten the connection screws.*
3. *Connect the 9 pin serial cable to a free serial interface of your PC.*

ⓘ Note or remember to which interface (COM1 or COM2) you connected the Pocket Modem 56k 3.1 at the PC.

### Connect the Pocket Modem 56k 3.1 to the phone network

→ You will need the supplied phone cord

1. *Plug the RJ12 jack of the cable into the RJ45 phone connection at the Pocket Modem 56k 3.1.*
2. *Plug the TAE or RJ12 jack of the cable into the phone socket of your phone connection.*

### Test the Pocket Modem 56k 3.1

- The Pocket Modem 56k 3.1 is connected to the PC.
  - The power supply of the Pocket Modem 56k 3.1 is switched on.
  - A terminal program such as TeraTerm is installed at the PC.
1. *Open your terminal program.*
  2. *Open the serial interface, to which the Pocket Modem 56k 3.1 is connected.*
  3. *Enter AT into your terminal program.*
    - ✓ The response will be OK.
    - *If you don't receive the response OK, check the connection and if the Pocket Modem 56k 3.1 receives power. Repeat the test.*
    - ✓ The RX/TX LED flashes while you type.
    - ⓘ If the RX/TX LED at the Pocket Modem 56k 3.1 does not flash, while you type **AT** and receive an **OK**, the reason may be that you are connected to another modem (e.g. with the modem integrated in the laptop or the PC).  
In this case, check to which interface your Pocket Modem 56k 3.1 is actually connected and repeat the test.
    - ✓ The Pocket Modem 56k 3.1 is successfully installed and ready for operation.

## 8 Operating Principle

This chapter describes the basis procedures to operate and configure a Pocket Modem 56k 3.1.

You have the possibility to operate and configure the Pocket Modem 56k 3.1 via AT commands. You can enter these commands yourself with the help of a terminal program and the AT command reference.

### 8.1 Operation with the Terminal Program

In general, any terminal program may be used. We recommend the program TeraTerm by T. Teranishi. It is available free of cost on the Internet at <http://hp.vector.co.jp/authors/VA002416/teraterm.html>.

#### Configuration and settings of the Pocket Modem 56k 3.1 with a terminal program

How to configure and operate the Pocket Modem 56k 3.1 with a terminal program.

- The Pocket Modem 56k 3.1 is connected to the PC and switched on.
- A terminal program is installed on the PC.

1. *Start your terminal program.*
2. *Open the serial port, to which you connected the Pocket Modem 56k 3.1.*

① COM1 under Windows corresponds to /dev/ttyS0 under Linux.

3. *Type the character string **AT** into the terminal program. Complete the entry by pressing the Enter key.*

① Each command input starts with **AT** and is completed with the Enter key.

✓ The Pocket Modem 56k 3.1 responds with **OK**:

- *If the Pocket Modem 56k 3.1 does not respond, this may have two reasons:*
  - a) *The Pocket Modem 56k 3.1 is switched off or*
  - b) *The Pocket Modem 56k 3.1 is connected to a different serial port. Check it and repeat step 3.*

4. *Configure the Pocket Modem 56k 3.1 with the help of the AT commands.*

- ① A reference of the AT commands can be found in the chapter "AT Command Reference".

5. *Save your entries with AT&W.*

- ① Not all settings at the Pocket Modem 56k 3.1 must be actively stored by entering **AT&W**. Some settings are automatically saved immediately. We still recommend sending the command **AT&W** to the Pocket Modem 56k 3.1 as your last configuration step to ensure that all settings are stored safely and are available for the next restart.



## 9 Functions

### 9.1 Establish or Accept a Data Connection

The Pocket Modem 56k 3.1 can call another modem via the phone line and establish a data connection. After calling a phone number, the Pocket Modem 56k 3.1 will synchronize with the called modem and opens a data connection with the transmission speed that is currently set at the serial interface. During the active data connection, all incoming characters are sent to the other, called modem. AT commands are therefore not processed. To ensure that the Pocket Modem 56k 3.1 will process AT commands during an active connection, it must be switched to command mode using the "Escape sequence". After that, the local Pocket Modem 56k 3.1 will process the entered characters as AT commands and will not transmit them to the remote terminal. A remote Pocket Modem 56k 3.1 can be switched to command mode during an active data connection, using the function "Remote configuration".

The Pocket Modem 56k 3.1 can also accept an incoming connection. The "Application" or the PC must support hardware data flow control at the serial interface with the terminal program, otherwise the Pocket Modem 56k 3.1 will not accept the incoming connection. Otherwise, the hardware data flow control in the Pocket Modem 56k 3.1 must be deactivated, in order for a connection to be accepted, regardless of the status of the application. After the preset number of ring tones, it will go off-hook and open a connection.

As default, the hardware data flow control is active.

#### Configuration with AT commands

To **establish a data connection** with the Pocket Modem 56k 3.1, use the command

**ATD<phonenumber>**

Replace **<phonenumber>** with the phone number of the remote terminal.

If another modem accepts the connection, the Pocket Modem 56k 3.1 will report

**CONNECT**

If the remote terminal is busy, the Pocket Modem 56k 3.1 will report

**BUSY**

---

If the remote terminal is not a modem, the Pocket Modem 56k 3.1 will report the following, after the remote terminal went off-hook

**NO CARRIER**

---

If the Pocket Modem 56k 3.1 does not receive a dial tone after it went off-hook before the dialing procedure, it will report

**NO DIALTONE**

---

If the Pocket Modem 56k 3.1 is connected to a **phone system**, it may occur that after it went off-hook no dialing tone is heard, but another acoustic sound.

**ATX3**

To make sure that the Pocket Modem 56k 3.1 **will not wait for the dialing tone before the dialing procedure**, select the following command before the dialing procedure

---

To **switch to command mode** during a data connection, use the Escape sequence

**+++**

After that, no data may be transmitted for 1 second for the Pocket Modem 56k 3.1 to switch to command mode.

---

To **switch back** to normal data transmission from the **command mode**, use the command

**ATO**

---

To **accept an incoming connection**, use the command

**ATA**

---

To set the **number of ring tones** after the Pocket Modem 56k 3.1 has gone off-hook and has accepted the connection, use the command

**ATS0=<n>**

Replace the **<n>** with the number of ring tones.

---

---

To **terminate a connection** and to prompt the Pocket Modem 56k 3.1 **ATH** to go off-hook, use the command

---

## 9.2 Select Country-Spezifc Presets

### Note

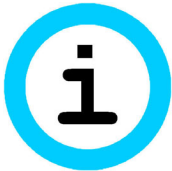

#### Loss of saved settings!

Changing the country code will reset all stored settings in the Pocket Modem 56k 3.1 to factory defaults (except the country code setting).

Download (or make notes of) the settings of your Pocket Modem 56k 3.1 before you change the country specific preset.

The Pocket Modem 56k 3.1 holds a range of presets, which allow you to adjust the device to the standards and requirements of the local telephone network. You find a list of countries and the corresponding country codes in the section „Country Codes“.

The default setting is „Europe“ with the country code „FD“.

### Configuration with AT commands

---

To choose the preset for the country where the the Pocket Modem 56k 3.1 is deployed, use the command: **AT+GCI=<n>**

---

## 9.3 Automatic Baud Rate Detection

### 9.3.1 Serial Connection

The automatic baud rate detection enables a continuous automatic adjustment of all parameters (baud rate, data format) of the serial interface at the Pocket Modem 56k 3.1. The device will detect during the operation, which baud rate and which data format is applied to the serial interface. After a restart, the Pocket Modem 56k 3.1 will restore the last working interface configuration. With each incoming AT command (according to the character string "AT"), the parameters for the interface of the Pocket Modem 56k 3.1 will be checked and adjusted, if necessary. This is the reason why **the baud rate can not be stored with the command AT&W**, as the Pocket Modem 56k 3.1 will immediately adjust its interface to the current parameters of the currently established serial connection.

The function is active as default.

## Configuration with AT commands

---

To set the baud rates **temporarily** (until the next "AT"), enter one of the following baud rates for **<n>**:

300, 600, 1200, 2400, 4800, 9600, 14400, 19200, 28800, 38400, 57600 or 115200 bps. **AT+IPR=<n>**

This setting can not be stored.

---

The Pocket Modem 56k 3.1 must be configured with the baud rate, which is used to operate the application at a later time, as the Pocket Modem 56k 3.1 will always use the last known functioning configuration of its interface.

### 9.3.2 Phone connection

The automatic negotiation of the baud rate and the modulation standard enables the Pocket Modem 56k 3.1 to negotiate the largest possible connection speed to the remote terminal while the connection is established. The speed depends on the settings and the abilities of the modem at the remote terminal. Via the modulation standard, the connection speed can be set through the phone line. If nothing is defined, the Pocket Modem 56k 3.1 will automatically try to determine the optimum connection parameters.

The function is active as default.

#### Configuration with AT commands

---

To configure the modulation standard and thus the connection speed, use the command: **AT+MS=<modulation>**

---

Please find the possible parameters for this command in the Chapter "AT Command reference".

---

To display the current settings: **AT+MS?**

---

For a list of possible parameter of the command, enter: **AT+MS=?**

---

## 9.4 Data Buffer for Serial Data Transmission

The Pocket Modem 56k 3.1 provides send and receive buffers. These buffers prevent the loss of data, in case the application or the remote terminal can not receive data at this time. The data buffer can be deactivated together with the error correction (bit direct mode). When the buffer is activated, the data flow control should be active to avoid a buffer overflow in the Pocket Modem 56k 3.1. If the buffer overflows, the data gets lost. **Operation without a buffer and error correction is only useful for special character framings.**

The function is active as default.

### Configuration with AT commands

---

To deactivate the error correction as well as the buffer in the Pocket Modem 56k 3.1 for applications with special data format, use the command:

**AT\N1**

---

To deactivate only the error correction, use the command:

**AT\N0**

---

## 9.5 Bit Direct Mode

For **special applications**, the buffering of the Pocket Modem 56k 3.1 can be deactivated using the setting "unbuffered, bit direct". All data is forwarded without buffering and further influence of the Pocket Modem 56k 3.1. This applies especially to the parity and stop bits. The error correction and the data compression are in this case switched off as well. If the Pocket Modem 56k 3.1 is operated in this mode, not all functions will be available. The remote configuration and all functions for which a password is required, will no longer be available. **This mode should only be used for special character framings.**

### Configuration with AT commands

---

To deactivate the buffer of the Pocket Modem 56k 3.1 and to switch on the bit direct mode, use the command:

**AT\N1**

---

## 9.6 Data Flow Control (Handshake)

The data flow control ensures that the data transfer is interrupted as soon as the modem buffer exceeds a certain level. Two data flow control options are available: Via the control lines RTS and CTS, or via the control characters XON/XOFF which are inserted into the data stream.

### 9.6.1 Hardware data flow control (RTS/CTS)

The hardware data flow control works in two directions. When the critical buffer level is exceeded, the modem will set the CTS line to "low" and will thus indicate to the application to interrupt the dataflow. When the buffer is emptied sufficiently for the Pocket Modem 56k 3.1 to be able to receive data again, the CTS line is set to "high". Reversely, the application can also indicate to the Pocket Modem 56k 3.1 to interrupt the data flow. This is done via the RTS line. If it is set to "low", the modem will interrupt the data flow to the application. The application will set it to "high" to request data from the Pocket Modem 56k 3.1. The data flow control with RTS/CTS behavior is active by default.

#### Configuration with AT commands

---

To switch the data flow control on and to set the type to RTS/CTS, use:	<b>AT&amp;K3</b>
---	------------------

---

To switch the data flow control off, use:	<b>AT&amp;K0</b>
---	------------------

---

### 9.6.2 Software data flow control (XON/XOFF)

When the input buffer of the modem exceeds a certain fill state, the modem will insert an XOFF character into the data stream to the application. This character will cause the application to send no more data. It will depend on the according application software if the XON/XOFF data flow control is supported.

After the input buffer of the modem is emptied so much that data can be received again, the modem will send an XON character to the application. This character will cause the application to send data to the modem again. Analogously, the application can insert XON/XOFF characters into the data stream to switch the data flow on and off. The XON/XOFF data flow control is only available when the transmitted data do not contain the characters XON or XOFF, which usually appear only in actual ASCII texts (7 bit). When binary data (programs, etc.) are transmitted, or in the XMODEM transmission protocol, for example, occasionally appearing XON or XOFF characters would disturb the operation.

#### Configuration with AT commands

---

To switch the data flow control on and to set the type to XON/XOFF, use:	<b>AT&amp;K4</b>
--	------------------

---

To switch the data flow control off, use:	<b>AT&amp;K0</b>
---	------------------

---

## 9.7 Error correction

The Pocket Modem 56k 3.1 masters the V.42 error correction protocol including the Microcom Networking Protocol Levels 2/3/4 (MNP2, MNP3, MNP4) and the data throughput optimization MNP10. The V.42 error correction includes the protocols LAPM (Link Access Procedure for Modem) and MNP4. LAPM is the preferred error correction. MNP 4 is supported to maintain the compatibility with other MNP modems. Both methods determine frames to transfer net data and use CRC (Cyclic Redundancy Check) check sums for error tests. In V.42, there is the option to have the modem identify if the partner is a V.42 modem, a MNP modem, or a modem without error correction. The modem can then autonomously adjust to the partner.

As default, the automatic selection of V.42LAPM or MNP4 or no correction is set.

### Configuration with AT commands

---

To define the type of error correction, use the command:	<b>AT\N&lt;n&gt;</b>
--	----------------------

---

To set V.42LAP-M or MNP4 error correction exclusively, use:	<b>AT\N2</b>
---	--------------

---

Use the following command for the Pocket Modem 56k 3.1 to automatically select V.42LAP-M, MNP4, or an error-corrected connection:	<b>AT\N3</b>
---	--------------

---

To set V.42LAP-M error correction exclusively, use:	<b>AT\N4</b>
---	--------------

---

For the buffered mode without error correction, use:	<b>AT\N0</b>
--	--------------

---

## 9.8 Data Compression

The Pocket Modem 56k 3.1 supports various data compression types. During the connection setup, it will automatically detect the type of data compression used by the remote terminal, or it is set to a certain type of data compression. Data compression is only available for error corrected connections. To be able to use data compression, both sides (sender and recipient) must be able to at least recognize and support the same data compression mode.

The default setting is the automatic selection of MNP5 and V42.bis and V.44 data compression (**AT%C3**).

### Configuration with AT commands

To select the compression type, use:	<b>AT%C&lt;n&gt;</b>
To completely switch off the compression, use the following commands:	<b>AT%C0</b> <b>AT+DS44=0</b>
To select the MNP4 compression:	<b>AT%C1</b>
To select the V42bis and V.44 data compression if they are switched on (see below):	<b>AT%C2</b>
To select the V42bis and MNP5 data compression if V42.bis compression is switched on (see below):	<b>AT%C3</b>
To switch on V.42bis compression:	<b>AT%C2</b>
To switch on V.44 compression:	<b>AT+DS44=3</b>
To switch off V.42bis compression:	<b>AT%C0</b>
To switch off V.44 compression:	<b>AT+DS44=0</b>



## 9.9 Selective Call Acceptance

If the selective call acceptance is activated, the Pocket Modem 56k 3.1 will only accept calls from previously defined callers. The Pocket Modem 56k 3.1 will identify the caller via CLIP. This must, however, be supported by the network provider or the phone system, where the modem is connected to. The list of phone numbers of the Pocket Modem 56k 3.1 has 8 storage locations altogether (N0 to N7).

### Configuration with AT commands

To activate the selective call acceptance, use the command:	<b>AT&amp;A1</b>
To switch the selective call acceptance off, use the following command:	<b>AT&amp;A0</b>
To display a complete list of stored phone numbers for the selective call acceptance, use:	<b>AT*N?</b>
To delete a single storage location, overwrite the storage location with an empty space after the character "=".	<b>AT*N&lt;n&gt;=</b>
To delete the entire phone list for the selective call acceptance:	<b>AT*N99</b>
To store the phone number <nr> in the storage location <n> , use:	<b>AT*N&lt;n&gt;=&lt;nr&gt;</b>

The Pocket Modem 56k 3.1 checks the phone number sent via CLIP for one of the stored numbers. The check starts on the "right", i.e. from the end of the phone number submitted by CLIP. This makes it possible to recognize a phone number, although a prefix such as "+49" or "0049" was placed before the number. Also, the number for the detection can be made variable with the help of wild cards. The stored phone numbers may not include any separators, such as dashes between prefix and phone number.

For example, to permit the numbers +49941686920, 0941686920, 0049941686920 as callers, just store 941686920 at the location number 1.	<b>AT*N1=941686920</b>
---	------------------------

For each variable digit in the phone number, an asterisk \* can be entered.

To keep the last two digits variable, e.g. to allow callers from extensions, use two (\*\*) characters.

---

**AT\*N1=9416869\*\***

## 9.10 Sending messages via data connection, SMS or Fax

The Pocket Modem 56k 3.1 can send a message via SMS, data connection, or as e-mail. The sending of messages can only be triggered via an AT command. By default, three attempts are made to send a message.

### Configuration with AT commands

To enable the SMS dispatch, first define the phone number of the SMS service center which is used to send the message. **AT&Z0=Phone number**

To prevent that the Pocket Modem 56k 3.1 does not wait for a phone number from the exchange (e.g. for configurations with phone systems), the dial tone detection can be turned off. **ATX3**

To define the type of the message dispatch (SMS to mobile phone, SMS to fixed network, data connection, see Table 1: Type of message transmission), use: **AT\*M<n>**

If you want to send the message to mobile phones, e.g. in the D2 network, use: **AT\*M4**

The connection type depends on the type of transmission, the provider and the end terminal. Please make sure to set the correct transmission type for the message of the Pocket Modem 56k 3.1. If you set SMS to mobile phone via D2, for example, you can only send SMS to mobile phones in the D2 network.

Some providers support the forwarding of a message to an e-mail address. Please contact your provider for further information. The following table shows various pre-settings of the Pocket Modem 56k 3.1 to send messages to different end devices.

Transmission	Protocol	Data Format	Example	
Data connection				<b>AT*M0</b>
SMS to Mobile	PET	8N1	D1 or E Network	<b>AT*M1</b>
SMS to Mobile	UCP	7E1		<b>AT*M2</b>
SMS to Mobile	PET	7E1		<b>AT*M3</b>
SMS to Mobile	UCP	8N1	D2 network	<b>AT*M4</b>
Fax				<b>AT*M5</b>
SMS to mobile phone or fixed network				<b>AT*M6</b>

Table 1: Type of message transmission

---

This setting must be saved.

**AT&W**

---

To enter the message text, use the command:

**AT\*v**

---

After this command is entered, the modem will respond and wait for the message text. Enter the text and complete the entry with the Enter key.

**New alarm text:**

---

## 9.11 Manual Sending of Messages

The group message or the individual pulse messages can be sent manually.

### Configuration with AT commands

---

To send the commands, use the command: **AT%A<n>**

---

Use <n> to address the messages which are supposed to be sent. The message no. 0 is the group message; the other pulse messages are addressed by 1 to 10. For example, the message no. 1 is sent with this command:

**AT%A1**

---

If the messages 1 to 10 are triggered, the sent message will always consist of the group message and the attached pulse message.

## 9.12 Switching on the Remote Configuration

The Pocket Modem 56k 3.1 can be configured remotely. It has a remote configuration mode. To configure the Pocket Modem 56k 3.1 remotely, a data connection to the modem to be configured must be established. This can be performed by calling the Pocket Modem 56k 3.1 from any modem. After switching into the remote configuration mode, AT commands can be sent to configure the Pocket Modem 56k 3.1.

To switch into the remote configuration mode, a data connection must be established between the modems. A particular connection type is not mandatory. We recommend using only error-corrected connections for the remote configuration to avoid AT command transfer errors.

The remote configuration is active as default.

### Configuration with AT commands

To turn the remote configuration on, use:	<b>AT*R1</b>
To enable the remote configuration, the automatic call acceptance (e.g. after 2 ring tones) must be activated.	<b>ATS0=2</b>
Activate the error correction, for example, for the Pocket Modem 56k 3.1 to automatically dial the V.42LAP-M or MNP4 error correction.	<b>AT\N2</b>
To enter a password for the remote configuration, use the command:	<b>AT*C</b>
Save the settings with:	<b>AT&amp;W</b>

## 9.13 Remote Configuration of the Pocket Modem 56k 3.1

### Perform the remote configuration

In the following, we show how you can configure the Pocket Modem 56k 3.1 remotely.

- You will need a modem which you can use to establish a connection to the Pocket Modem 56k 3.1.
- You will need a terminal program.

1. *Open your terminal program.*
2. *Establish a connection to the Pocket Modem 56k 3.1. Use the local modem to dial the phone number of the Pocket Modem 56k 3.1 with `ATD<phonenumber>`.*

✓ The local modem establishes a connection.

3. *After the connection has been established, enter `****` (four asterisks). This will switch you into remote maintenance mode.*

✓ If you set a password, you will now need to enter it.

✓ After you successfully entered the password, the Pocket Modem 56k 3.1 will send a prompt in form of an ">".

✓ You can now configure the Pocket Modem 56k 3.1 remotely.

ⓘ Some AT commands are not available in remote maintenance mode. The AT commands are **ATA**, **ATD**, **ATO**, **AT&F**, **AT/B**.

4. *Complete the remote configuration by entering `AT*E`.*

✓ The Pocket Modem 56k 3.1 is now in the normal data connection mode. You can now exchange data between your local modem and the Pocket Modem 56k 3.1, or terminate the connection.

ⓘ Enter `****` to re-initiate a remote configuration.

## 9.14 Access Control and Security Callback

To protect yourself from unauthorized access via the phone line, the modem may be protected by a password. This password is used to establish a data connection, for security callback and remote configuration. This means: If the access control is activated, the system will prompt you for a password before outgoing connections and when dialing into the Pocket Modem 56k 3.1 for remote configuration. After successful authentication, the function Security Callback will trigger a callback from the Pocket Modem 56k 3.1 to a predefined number.

The factory default *standard password* is "QWERTY".

### Configuration with AT commands

To change the password, use	<b>AT*C</b>
To turn the access control for incoming and outgoing connections on, use	<b>AT*P1</b>
To turn the access control off, use	<b>AT*P0</b>
To accept a call, the automatic call acceptance must be activated:	<b>ATS0=2</b>
To activate the security callback and to save the phone number to be called, use the command:	<b>AT&amp;Z1=&lt;YourNumber&gt;</b>
Please note: If you operate the Pocket Modem 56k 3.1 at a phone system, which will not provide an exchange after going off-hook, enter the character for the exchange together with the phone number.	
To activate the security callback and to call back the caller identified by CLIP instead of a special phone number, use the command:	<b>AT&amp;Z1=C</b>
Please note that a phone system may make a callback impossible, if it requires an exchange first. Some phone systems, however, can add the character for the exchange to the CLIP which they send to the end device.	
To store the command, use the command:	<b>AT&amp;W</b>

### Triggering a "Security Callback"

How to trigger a security callback of the Pocket Modem 56k 3.1:

- You will need another modem to be able to connect to the Pocket Modem 56k 3.1.
- The security callback function at the Pocket Modem 56k 3.1 is activated.
- The automatic call acceptance at the Pocket Modem 56k 3.1 is activated.
- ① Use the function "selective call acceptance" to be able to restrict the number of callers who can trigger a security callback.
- *If you use another Pocket Modem 56k 3.1 to trigger a security callback at a Pocket Modem 56k 3.1, the access control must be deactivated at one of the devices.*
- Your second modem can be reached at the number stored in the Pocket Modem 56k 3.1. It must be able to accept calls.
- You will need a terminal program.



**1. *Establish a connection to the Pocket Modem 56k 3.1.***

- ✓ The Pocket Modem 56k 3.1 responds the incoming call.  
Connect  
SECURITY CALLBACK  
REMOTE PASSWORD:
- ✓ The Pocket Modem 56k 3.1 prompts you to enter the password.
- ⓘ The standard password is "QWERTY".

**2. *Enter the password.***

- ✓ After three unsuccessful password entries, the Pocket Modem 56k 3.1 will hang up.
- ✓ After 10 seconds, the Pocket Modem 56k 3.1 will dial the stored phone number.
- ⓘ The Pocket Modem 56k 3.1 performs 3 dialing attempts with 10 seconds pause before each subsequent attempt.
- ✓ If the called modem responds, a normal data connection exists.

## 9.15 Idle Connection Control with Data Transmit Control

The Data Transmit Control (DTC) is a function of the Pocket Modem 56k 3.1 which monitors the data transmission in online mode. This function prevents the Pocket Modem 56k 3.1 to stay online for an unlimited amount of time, although no data is being transmitted anymore. The DTC function can define the time after which the Pocket Modem 56k 3.1 will hang up as soon as there is no data transfer on the phone line.

### Configuration with AT commands

---

To define the time, after which the Pocket Modem 56k 3.1 should hang up, if no data transmission is available, use the command

You can select a value between 1 and 255 seconds for `<n>`. Please note that the timer `ATS15=<n>` will start running, as soon as the Pocket Modem 56k 3.1 goes off-hook ("OH" LED lights up). We therefore strongly recommend to avoid setting times below 20 seconds.

---

## 9.16 Priority Circuit for a Phone Connected in Series to the Pocket Modem 56k 3.1

The Pocket Modem 56k 3.1 may give a phone connected in series priority, to make sure the modem functions interfere as little as possible with the usage of the phone connection. The Pocket Modem 56k 3.1 can determine on the basis of the voltage in the line, if the phone line is used by a phone, if a phone in series is going off-hook or if the remote terminal of the Pocket Modem 56k 3.1 is terminating the connection.

The functions of the priority circuit may be combined or used individually. The functions can be selected and activated with the AT command `AT-STE=<n>`.

The following table provides the combination of functions with the according `AT-STE` command.

Command	Detecting a busy phone line	Going off-hook by telephone	Remote terminal connection abort
AT-STE=0	Off	Off	Off
AT-STE=1	On	Off	Off
AT-STE=2	Off	On	Off
AT-STE=3	On	On	Off
AT-STE=4	Off	Off	On
AT-STE=5	On	Off	On
AT-STE=6	Off	On	On
AT-STE=7	On	On	On

Table 5: Possible combinations of the individual functions of the priority circuit

The modem detects the status of the phone line at the voltage levels in the line. Optionally, the voltages for the various line states can be set with the command **AT-TTE=U1,U2,U3**. The voltages U1, U2 and U3 are by default set to functioning values and need not be modified. The following illustration shows the voltage curve for the according line state and the appropriate AT command parameters.

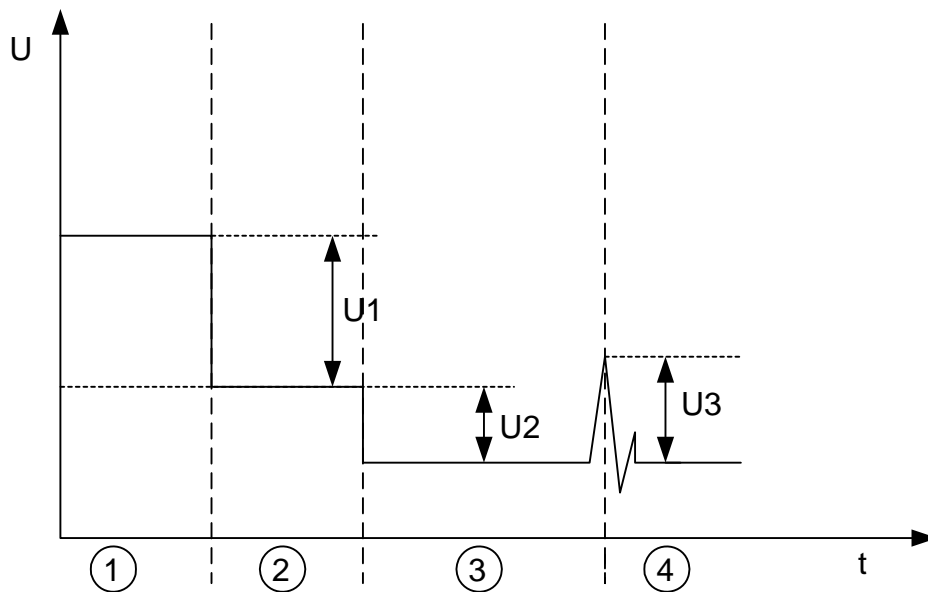

Figure 5: Line states and voltages in the line

State	Description
1	No connection has been established. The line is free.
2	A connection has been established. The telephone is off-hook and connected to a remote terminal. The voltage in the line has dropped with the amount of U1. The Pocket Modem 56k 3.1 can thus detect that the line is busy.
3	A connection has been established, but this time the Pocket Modem 56k 3.1 occupies the line and is connected to a remote terminal. If the telephone connected in series goes off-hook, the voltage will drop with the amount U2. The Pocket Modem 56k 3.1 will detect that the phone has gone off-hook and will terminate the connection.
4	The line is busy during a modem connection. After the remote terminal hangs up, the Pocket Modem 56k 3.1 will detect through the short power spike U3 (the crackling noise in the line) that the remote terminal has hung up. This will set the event code of the S registry 86 to 25 (remote terminal has hung up). This means that the Pocket Modem 56k 3.1 will not keep the line busy for an unnecessarily long period. If phone systems are used which dampen the crackling noise or the short power spike, it may occur that the system will not detect that the remote terminal has hung up.

Table 6: Line states and behavior of the priority circuit

### Configuration with AT commands

To use the desired functions of the priority circuit, use: **AT-STE=<n>**

To set the voltage level for the detection of the line status, use:

U1 is the voltage difference in the phone line between hung up state (free line) and the busy line.

U2 is the voltage difference, which is generated in the phone line when the Pocket Modem 56k 3.1 has already gone off-hook and a telephone connected in series is going off-hook. **AT-TTE=U1 , U2 , U3**

U3 is the voltage difference in the phone line between hung up state (free line) and the busy line.

To store the command, use the command: **AT&W**

## 9.17 Reset

There are two methods to reset the Pocket Modem 56k 3.1: by briefly disconnecting the supply voltage, or by using an AT command.

### Configuration with AT commands

---

To reset the Pocket Modem 56k 3.1, use the command **ATZ**

---

To reset the Pocket Modem 56k 3.1 and load the settings stored in user profile „0“, use the command **ATZ0**

---

To reset the Pocket Modem 56k 3.1 and load the settings stored in user profile „1“, use the command **ATZ1**

---

To reset the Pocket Modem 56k 3.1 to factory defaults, use the command **AT&F&WZ**

---

## 9.18 Firmware Update

### Note

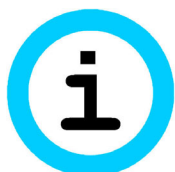

#### Function loss due to faulty update!

The Pocket Modem 56k 3.1 may lose its function, if it is updated with a wrong firmware or if the transfer of the firmware was faulty.

Before updating the firmware of the Pocket Modem 56k 3.1, contact the INSYS MICROELECTRONICS support department. They will provide you with the suitable firmware version for your Pocket Modem 56k 3.1.

The firmware of the Pocket Modem 56k 3.1 can be updated to add more functions to the Pocket Modem 56k 3.1 or to improve the existing functions. A firmware update can be performed with the help of a terminal program that supports ASCII uploads (e.g. TeraTerm).

#### Firmware update with a terminal program

How to load new firmware to the Pocket Modem 56k 3.1.

- You will need a terminal program that supports ASCII file transfers, such as TeraTerm.
- You will need the firmware that is suitable for your Pocket Modem 56k 3.1.
- The Pocket Modem 56k 3.1 is connected to the PC.

1. *Start your terminal program.*
2. *Activate hardware handshake in the terminal program.*
3. *Open the serial interface, to which the Pocket Modem 56k 3.1 is connected.*
4. *Set the baud rate in the terminal program to 57600 baud.*
5. *Type in "AT" and confirm with "Enter".*

✓ The Pocket Modem 56k 3.1 responds with OK:

➤ *If the Pocket Modem 56k 3.1 does not respond, check the connection and if the device receives power at all. Continue with step 2.*

ⓘ The firmware upload can not function without the hardware handshake. The input buffer at the serial interface of the Pocket Modem 56k 3.1 flows over and the Pocket Modem 56k 3.1 resets itself. In this case, you will hear the relays click during the upload. It is possible that an error message is displayed.

- ❗ Before you start with the upload, ensure that no other programs are active on your system, which could interrupt the data flow at the serial interface. Opening a DVD drive, playing music or connecting a USB device can also disturb or interrupt the data flow. As a result, the Pocket Modem 56k 3.1 may fail to function, and only INSYS MICROELECTRONICS will be able to restore it.
- 6. *Type **AT\*\*** to start the firmware upload.*

  - ✓ The modem reports "Download initiated...".
- 7. *Use the terminal program to send the file with the firmware loader, such as "HS\_LADER.S37".*

  - ❗ If you do not send a firmware file, the Pocket Modem 56k 3.1 will terminate the procedure after approx. 60 seconds.
  - ✓ The upload progress is displayed by dots in the terminal window.
  - ✓ The Pocket Modem 56k 3.1 reports the successful upload of the firmware loader, for example with
 

```
Flash loader - Rev 27
Standard d/load mode
SST 39VF/LF020 Mfr_ID=BF, Device_ID=D6
2MBit Device Detected
Download flash code ..
```
  - *If you didn't receive the previous message for a successful upload, the upload has most probably failed. Try to reset the Pocket Modem 56k 3.1 and to repeat the process from step 4. If this fails and the Pocket Modem 56k 3.1 does no longer react to AT commands, please contact the INSYS MICROELECTRONICS support department.*
- 8. *Use the terminal program to send the file with the firmware, such as "20B7.S37".*

  - ✓ The upload progress is again displayed by dots in the terminal window.
  - ✓ After a successful upload, the Pocket Modem 56k 3.1 will display:
 

```
Device successfully programmed
```
  - ✓ The Pocket Modem 56k 3.1 will reset itself and is ready for operation.

## 10 Maintenance, Repair and Troubleshooting

### 10.1 Maintenance

The product is maintenance-free and does not require special regular maintenance.

### 10.2 Troubleshooting

If a failure occurs during the operation of the product, you will find troubleshooting tips in the "Knowledge Base" on our web site (<http://www.insys-icom.de/knowledge/>). If you need further support, please contact the INSYS icom Support. You can contact our support department via e-mail under [support@insys-tec.de](mailto:support@insys-tec.de) and via phone under +49 941 58692-0.

### 10.3 Repair

Send defect devices with detailed failure description to the source of supply of your device. If you have purchased the device directly from INSYS icom, send the device to: INSYS MICROELECTRONICS GmbH, Waffnergasse 8, 93047 Regensburg.

#### Caution!



**Short circuits and damage due to improper repairs and modifications as well as opening of products.**

**Fire hazard and damage of the product.**

It is not permitted to open the product for repair or modification.



# 11 Waste Disposal

## 11.1 Repurchasing of Legacy Systems

According to the new WEEE guidelines, the repurchasing and recycling of legacy systems for our clients is regulated as follows:

Please send those legacy systems to the following address, carriage prepaid:

Frankenberg-Metalle  
Gaertnersleite 8  
D-96450 Coburg  
Germany

This regulation applies to all devices which were delivered after August 13, 2005.

## 12 Declaration of Conformity

This device complies with the requirements set out in the Council Directive on the Approximation of the Laws of the Member States relating to Electromagnetic Compatibility 2004/108/EC and the Council Directive relating to Low Voltage 2006/95/EC as well as the Council Directive R&TTE 1999/5/EC.

We will gladly send you a copy of the declaration of conformity on request.

## 13 AT Command Reference

Command	Description
<b>AT**</b>	<u>Start of the flash load function</u>
<b>ATA</b>	<u>Answer mode</u> The Pocket Modem 56k 3.1 modem is switched into response mode. This is only effective in Germany, if the connected phone goes off-hook or if a call comes in.
<b>A/</b>	<u>Repeat the last command</u> The last command is repeated.
<b>AT\<u>A</u>&lt;n&gt;</b>	<u>Select maximum MNP block size</u> Define maximum block size for error corrected MNP transmissions. <b>AT\<u>A</u>0</b> 64 byte <b>AT\<u>A</u>1</b> 128 byte (default) <b>AT\<u>A</u>2</b> 192 byte <b>AT\<u>A</u>3</b> 256 byte
<b>AT*<u>A</u>&lt;n&gt;</b>	<u>Automatic call acceptance ON/OFF</u> <b>AT*<u>A</u>0</b> Call acceptance is blocked, irrespective of S0 <b>AT*<u>A</u>1</b> Call acceptance according to S0 (default) <b>Note: see also S-Registry 36, bit 7</b>
<b>AT&amp;<u>A</u>&lt;n&gt;</b>	<u>Selective Call Answer On or Off</u> To evaluate selective call answer, the phone number must be transmitted (CLIP). The following countries support the "CLIP" function: Australia, Belgium, China, Denmark, Germany, Finland, Great Britain, Hong Kong, India, Ireland, Iceland, Italy, Canada, Korea, New Zealand, The Netherlands, Norway, Austria, Sweden, Singapore, Spain, Taiwan, USA. <b>AT&amp;<u>A</u>1</b> Switches the selective call answer ON <b>AT&amp;<u>A</u>0</b> Switches the selective call answer OFF (default) <b>The AT&amp;A setting is saved in AT&amp;W.</b>
<b>AT%<u>A</u>&lt;n&gt;</b>	<u>Send alarm text manually</u> Manual triggering of the message. After the message is sent, the device responds with OK (success) or ERROR (failure). <b>Note: see also AT*<u>V</u>&lt;n&gt;</b>

Command	Description
<b>AT\B&lt;n&gt;</b>	<p><u>Send "break" to the other Pocket Modem 56k 3.1</u></p> <p>For connections that were not error corrected the Pocket Modem 56k 3.1 sends a break signal to the other Pocket Modem 56k 3.1. The length of the signal is: the specified parameter times 1/10 of a second.</p> <p>For error corrected connections, the Pocket Modem 56k 3.1 sends a break signal according to the active error correction protocol without considering a parameter specification.</p> <p>If no connection is established or if a fax connection is active, an error message is displayed.</p> <p><b>AT\B1</b>          1/10 second break signal</p> <p><b>AT\B2</b>          2/10 second break signal</p> <p><b>AT\B3</b>          3/10 second break signal</p> <p><b>AT\B4</b>          4/10 second break signal</p> <p><b>AT\B5</b>          5/10 second break signal</p> <p><b>AT\B6</b>          6/10 second break signal</p> <p><b>AT\B7</b>          7/10 second break signal</p> <p><b>AT\B8</b>          8/10 second break signal</p> <p><b>AT\B9</b>          9/10 second break signal</p>
<b>AT%B&lt;n&gt;</b>	<p><u>Switch key abort on and off during connection</u></p> <p><b>%B0</b>            Key abort is active. Each character on the TX line will result in an interruption of the connection setup (default)</p> <p><b>%B1</b>            Key abort is deactivated. A connection setup can not be interrupted manually. A connection setup can only be terminated via DTR drop, internal canceling of the Pocket Modem 56k 3.1 (<b>NO DIALTONE, BUSY</b>) or Timeout (<b>NO CARRIER</b>). (S-Registry 36 Bit 6)</p>
<b>AT%C&lt;n&gt;</b>	<p><u>Enable data compression</u></p> <p>Enable/disable a data compression type</p> <p>The Pocket Modem 56k 3.1 can only perform data compression for error corrected connections.</p> <p><b>AT%C0</b>          No data compression enabled</p> <p><b>AT%C1</b>          MNP 5 data compression enabled</p> <p><b>AT%C2</b>          Enable V.42bis and V.44 data compression</p> <p><b>AT%C3</b>          Enable MNP 5 and V.42bis data compression (default)</p>

Command	Description
<b>AT*C</b>	<p><u>Remote configuration password</u></p> <p>This password secures the remote configuration as well as incoming data connections (see <b>AT*P</b>) and security callback.</p> <p><b>OLD PASSWORD</b>      Requires the old password (default: <b>QWERTY</b>). Wrong input leads to <b>ERROR</b>.</p> <p><b>NEW PASSWORD</b>      Enter the new password with 6 to 12 characters.</p> <p><b>CONFIRM</b>              Repeat the new password. Wrong input leads to <b>ERROR</b>.</p> <p><b>OK</b>                      The password is immediately stored in the EEPROM.</p>
<b>AT&amp;C&lt;n&gt;</b>	<p><u>DCD (CT109) behavior</u></p> <p>Behavior of the RS232 DCD output of the Pocket Modem 56k 3.1.</p> <p><b>AT&amp;C0</b>                  DCD is always ON</p> <p><b>AT&amp;C1</b>                  DCD follows the carrier signal of the phone line (default)</p>
<b>AT+CMGF=&lt;n&gt;</b>	<p><u>Set the SMS dispatch format with AT+CMGS</u></p> <p><b>AT+CMGF=0</b>              Sets the PDU mode for the SMS dispatch via <b>AT+CMGS</b> (default).</p> <p><b>AT+CMGF=1</b>              Sets the text mode for the SMS dispatch via <b>AT+CMGS</b>.</p>
<b>AT+CMGS=&lt;n&gt;</b>	<p><u>SMS dispatch directly via AT command</u></p> <p>Depending on the setting of <b>AT+CMGF=&lt;n&gt;</b>, the command <b>AT+CMGS=&lt;n&gt;</b> will have a different syntax.</p> <p><b>Setting AT+CMGF=1 (text mode):</b>  <b>AT+CMGS=&lt;phonenumber&gt;</b></p> <p>The Pocket Modem 56k 3.1 returns the "&gt;" character and awaits the SMS text (up to 160 characters), ending with an EOF character (0x1A or STRG-Z).</p> <p><b>Notes:</b></p> <ul style="list-style-type: none"> <li>➤ Depending on the provider, the phone number must be entered in the format "0941xxx" or "49941xxx" (see <b>AT*M</b> and/or <b>AT&amp;Z2</b>).</li> <li>➤ After the sending procedure was successful, the Pocket Modem 56k 3.1 will return "+CMGS: 000".</li> </ul> <p><b>Setting AT+CMGF=0 (PDU mode):</b>  <b>AT+CMGS=&lt;PDU string length&gt;</b></p> <p>The Pocket Modem 56k 3.1 returns the character "&gt;" and awaits the PDU string, ended with an EOF character (0x1A or STGR-Z).</p> <p><b>Notes:</b></p> <ul style="list-style-type: none"> <li>➤ Depending on the provider, the phone number must be entered in the format "0941xxx" or "49941xxx" (see <b>AT*M</b> and/or <b>AT&amp;Z2</b>).</li> <li>➤ "Numbering Plan" is ignored.</li> <li>➤ The service center is defined by <b>AT&amp;Z0</b>, the SCA field in the PDU string is ignored.</li> <li>➤ Message header, confirmation SMS and validity period are not supported.</li> <li>➤ Data coding scheme: Only the "default alphabet" is supported.</li> <li>➤ After the sending procedure was successful, the Pocket Modem 56k 3.1 will return "+CMGS: &lt;MR&gt;" where &lt;MR&gt; is the message reference defined in the</li> </ul>

Command	Description
	<p style="text-align: center;"><b>PDU string.</b></p>
<b>AT+CPIN?</b>	<p><u>Dummy command for GSM compatibility</u>  <b>AT+CPIN?</b> responds with "<b>+CPIN: READY</b>".  <b>Note: This command only serves for the purpose of compatibility with applications for GSM devices.</b></p>
<b>AT+CREG?</b>	<p><u>Dummy command for GSM compatibility</u>  <b>AT+CREG?</b> responds with "<b>+CREG: 0,1</b>".  <b>Note: This command only serves for the purpose of compatibility with applications for GSM devices.</b></p>
<b>AT+CSQ</b>	<p><u>Dummy command for GSM compatibility</u>  <b>AT+CSQ</b> responds with "<b>+CSQ: 20.99</b>".  <b>Note: This command only serves for the purpose of compatibility with applications for GSM devices.</b></p>
<b>AT+CPMS?</b>	<p><u>Dummy command for GSM compatibility</u>  <b>AT+CPMS?</b> responds with "<b>+CPMS: "MT",8,40,"MT",8,40,"MT",8,40</b>".  <b>Note: This command only serves for the purpose of compatibility with applications for GSM devices.</b></p>

Command	Description
<p><b>ATD&lt;n&gt;</b></p>	<p><u>Dial</u></p> <p>The Pocket Modem 56k 3.1 goes off-hook and dials according to the dialing string transmitted via the <b>ATD</b> command. After the dialing procedure, the Pocket Modem 56k 3.1 attempts to establish a connection. If the <b>ATD</b> command was performed without a dialing string, the Pocket Modem 56k 3.1 goes off-hook and attempts to connect to the other Pocket Modem 56k 3.1 (without dialing). The behavior of the Pocket Modem 56k 3.1 depends on the activation of the line current recognition (see <b>ATX</b> command). The execution of the <b>ATD</b> command also depends on when the last dialing attempt was performed.</p> <p>In the mode <b>AT+FCLASS=0</b>, the Pocket Modem 56k 3.1 acts like a data modem. It attempts to connect to another data modem. This attempt is repeated until the waiting period that was specified in the S7 registry has expired.</p> <p>If this period is exceeded, the Pocket Modem 56k 3.1 hangs up and the following error message appears: <b>NO CARRIER</b>.</p> <p>In the mode <b>FCLASS=1</b> or <b>=2</b>, the Pocket Modem 56k 3.1 acts as a fax modem. It attempts to connect to another fax or fax modem. (The Pocket Modem 56k 3.1 goes into receive status HDLC V.21 channel 2, as if the command <b>AT+FRH</b> had been executed.)</p> <p>The following characters may be transmitted as parameters (brackets, punctuation marks, spaces and semicolons are ignored):</p> <p><b>0 to 9</b>      The digits from 0 to 9</p> <p><b>*</b>            The asterisk: Only for tone dialing</p> <p><b>#</b>            The hash: Only for tone dialing</p> <p><b>A-D</b>         The inband signaling characters A, B, C, D</p> <p><b>P</b>            Pulse dialing mandatory: Pulse or tone dialing is required according to the region.</p> <p><b>T</b>            Tone dialing mandatory: Pulse or tone dialing is required according to the region.</p> <p><b>W</b>            Wait for dialing tone: The Pocket Modem 56k 3.1 waits for the dialing tone before it starts to dial. If no dialing tone was detected within the period specified in the S6 registry, the Pocket Modem 56k 3.1 hangs up and an error message is displayed.</p> <p><b>@</b>            Waiting for silence: The Pocket Modem 56k 3.1 waits at least five seconds for silence in the line, before it executes the next character from the parameter string. If this five second silence can not be detected and the abort period in the S7 registry has not been exceeded, the Pocket Modem 56k 3.1 terminates the connection displaying the message: <b>NO ANSWER</b>.</p> <p>If busy signal recognition was activated, the Pocket Modem 56k 3.1 terminates the connection displaying the message: <b>BUSY</b>.</p> <p>If a response tone from the other Pocket Modem 56k 3.1 is received during the waiting period, a connection is established.</p>

Command	Description
<b>ATD&lt;n&gt;</b> <i>(continued)</i>	<p><b>,</b> Dial tone delay: The Pocket Modem 56k 3.1 performs a dial tone delay before it executes the next character of the parameter string. The delay length is defined in the S8 registry.</p> <p><b>L</b> Last number re-dialing.</p> <p><b>;</b> Return to the input mode after dialing. It is added to the end of the dialing string and causes the Pocket Modem 56k 3.1 to return to the entry mode when it reaches “;” (with: message <b>OK</b>). This enables the input of <b>AT</b> commands even with a receiver off-hook. The additional <b>AT</b> commands can follow in the same input line after the “;” or they can be transmitted to further input lines. The <b>ATH</b> command will abort the connection and the receiver is hung up.</p> <p><b>S=n</b> Dialing the n-th number from the number pool, which was set up with the <b>AT&amp;Z&lt;n&gt;</b> command.</p> <p><b>!</b> If the character “!” is a part of the dialing string, the Pocket Modem 56k 3.1 will hang up within the time frame determined in S29 and then goes off-hook again.</p> <p><b>^</b> Suppresses the sending of a ringing tone.</p> <p><b>ATD12345;</b> The semicolon (;) causes the return to the input mode after dialing.</p> <p><b>Default:</b> Ringing tone is sent for fax operation. No ringing tone for data operation.</p> <p><b>( )</b> Are ignored: They are just used as an outline.</p> <p><b>-</b> Are ignored: They are just used as an outline.</p> <p><b>, ,</b> Space characters are ignored: They are just used as an outline.</p> <p><b>Examples:</b></p> <p><b>ATD12345</b> Dial the phone number 12345</p> <p><b>ATDP12345</b> Dial the phone number 12345 with the pulse dialing method</p> <p><b>ATDT12345</b> Dial the phone number 12345 with the tone dialing method</p> <p><b>ATX3D0W12345</b></p> <p>For PBXs, which connect to the exchange line using the prefix 0 (or 9): First, blind dialing is activated by: <b>x3</b> (see the command „<b>ATX3</b>“) to be able to dial a leading 0 without hearing a dialing tone. After 0 has been dialed via: <b>D0</b> dialing tone recognition can be switched on again using the parameter: <b>w</b>. The Pocket Modem 56k 3.1 thus waits for the dialing tone and continues with the rest of the dial-up (via: 12345) only after hearing the dialing tone. Waiting for the dialing tone may be omitted. In this case, the dialing command is <b>ATX3D012345</b>.</p>



Command	Description
<b>AT&amp;D&lt;n&gt;</b>	<p><u>DTR (CT108/2) behavior</u></p> <p>DTR (CT108/2) behavior - Monitoring on/off transitions of the RS232 DTR line of the PC.</p> <p><b>AT&amp;D0</b> DTR is ignored. Allows the operation with PCs which do not run DTR.</p> <p><b>AT&amp;D1</b> A DTR on/off transition causes the Pocket Modem 56k 3.1 to react as if it had received an abort sequence <b>+++</b>. The Pocket Modem 56k 3.1 switches to the input mode without hanging up.</p> <p><b>AT&amp;D2</b> A DTR on/off transition causes the Pocket Modem 56k 3.1 to hang up. Going off-hook automatically is not possible. (default)</p> <p><b>AT&amp;D3</b> A DTR on/off transition causes the Pocket Modem 56k 3.1 to perform a reset as if an <b>ATZ</b> command had been executed. A preceded <b>AT&amp;Y</b> command decides if either the default 0 or 1 is loaded.</p>
<b>AT+DS=&lt;n&gt;</b>	<p><u>Activate/deactivate V.42bis data compression</u></p> <p><b>AT+DS=0</b> Deactivates V.42bis data compression</p> <p><b>AT+DS=3</b> Activates V.42bis data compression (default)</p>
<b>AT+DS44=&lt;n&gt;</b>	<p><u>Activate/deactivate V.44 data compression</u></p> <p><b>AT+DS44=0</b> Deactivates V.44 data compression</p> <p><b>AT+DS44=3</b> Activates V.44 data compression (default)</p>
<b>ATE&lt;n&gt;</b>	<p><u>Command entry Echo</u></p> <p>This command toggles the responses, which the Pocket Modem 56k 3.1 creates as reactions from application commands (Echo), ON or OFF.</p> <p><b>ATE0</b> Switch off Echo</p> <p><b>ATE1</b> Switch on Echo (default)</p>
<b>AT%E&lt;n&gt;</b>	<p><u>Automatic Retrain</u></p> <p>When transmission problems occur, the Pocket Modem 56k 3.1 executes a retrain procedure. After three unsuccessful retrain attempts, the Pocket Modem 56k 3.1 will hang up.</p> <p><b>AT%E0</b> Retrain not allowed</p> <p><b>AT%E1</b> Retrain allowed</p> <p><b>AT%E2</b> Fall back, fall forward allowed (default)</p>
<b>AT*E</b>	<p><u>Terminate remote configuration</u></p> <p>The command <b>AT*E</b> terminates a remote configuration.</p>
<b>AT&amp;F</b>	<p><u>Loading the default factory settings</u></p> <p>The Pocket Modem 56k 3.1 loads the default factory setting from the internal, non-volatile memory. This puts the Pocket Modem 56k 3.1 into a defined basic state. <b>AT&amp;F</b> also overwrites a part of the S registry.</p> <p>The Pocket Modem 56k 3.1 has the following two defaults: (<b>AT&amp;F0</b>, <b>AT&amp;F1</b>).</p>

Command	Description
<b>AT+GCI=&lt;n&gt;</b>	<p><u>Set country code</u></p> <p>The command <b>AT+GCI</b> allows the customization of the modem for different countries. As default, the Pocket Modem 56k 3.1 is set to Europe (CTR21) with <b>AT+GCI=FD</b>. Currently, the Pocket Modem 56k 3.1 is only authorized for this country profile.</p> <p><b>Note:</b>           <b>Please note that all country settings will result in ALL modem settings being reset to the default settings (such as AT&amp;F&amp;W). Therefore, please select a country profile first and adjust the settings afterwards.</b></p>
<b>ATH</b>	<p><u>Disconnect connection</u></p> <p>The Pocket Modem 56k 3.1 terminates the connection.</p>
<b>AT*H&lt;n&gt;</b>	<p><u>Declaration of the connection protocol speed (MNP 10)</u></p> <p><b>AT*H&lt;n&gt;</b> determines the speed that is used to exchange the declarations during the MNP10 connection setup before the modems enter the MNP 10 mode.</p> <p><b>AT*H0</b>           Connection setup takes place with the highest possible speed. (default)</p> <p><b>AT*H1</b>           Connection setup takes place with 1,200 bps</p> <p><b>AT*H2</b>           Connection setup takes place with 4800 bps</p>
<b>ATI&lt;n&gt;</b>	<p><u>Identification</u></p> <p>The Pocket Modem 56k 3.1 sends an identification to the PC, according to the following parameter:</p> <p><b>ATI0</b>           Product code</p> <p><b>ATI1</b>           Previously calculated EPROM checksum</p> <p><b>ATI2</b>           Calculation of the EPROM checksum and comparison with the previously calculated checksum stored in the EPROM. OK for correct comparison.</p> <p><b>ATI3</b>           Number of firmware version in the EPROM</p> <p><b>ATI4</b>           Pocket Modem 56k 3.1 Version number</p> <p><b>ATI5</b>           Country code parameter (Germany = 006/Europe = 253)</p> <p><b>ATI6</b>           Version number and revision of "data pump"</p>
<b>AT+IPR=&lt;n&gt;</b>	<p><u>Determine baud rate</u></p> <p>Use the command <b>AT+IPR</b> to temporarily set a certain baud rate.</p> <p><b>AT+IPR=0</b>       Activates the automatic baud rate detection (default)</p> <p><b>AT+IPR=&lt;n&gt;</b>     Sets the Pocket Modem 56k 3.1 temporarily to the fixed baud rate n. The following baud rates are supported: 300, 1,200, 2,400, 4,800, 9,600, 19,200, 38,400, 57,600 and 115,200.</p> <p>The setting <b>AT+IPR</b> is not stored with <b>AT&amp;W</b>.</p>

Command	Description
<b>AT&amp;K&lt;n&gt;</b>	<p data-bbox="352 248 1417 277"><u>Select data flow control between the PC and the Pocket Modem 56k 3.1 (handshake)</u></p> <p data-bbox="352 297 770 327">Fax operation default is RTS/CTS.</p> <p data-bbox="352 347 798 376"><b>AT&amp;K0</b>            No data flow control</p> <p data-bbox="352 396 1062 425"><b>AT&amp;K3</b>            Select data flow control RTS/CTS (default)</p> <p data-bbox="352 445 979 474"><b>AT&amp;K4</b>            Select data flow control XON/XOFF</p> <p data-bbox="352 495 1129 524"><b>AT&amp;K5</b>            Select transparent data flow control XON/XOFF</p> <p data-bbox="352 544 1150 573"><b>AT&amp;K6</b>            Select RTS/CTS and XON/XOFF data flow control</p> <p data-bbox="352 593 1426 775"><b>AT&amp;K8</b>            Activates the controlled half duplex operation on the serial interface for RS485. In this mode, the CTS signal is deactivated (high), while the Pocket Modem 56k 3.1 sends data at the serial interface. Thus, the CTS signal can be used as driver release signal for a RS485 driver. The polarity can be set with <b>AT&amp;R</b>.</p>
<b>AT-K&lt;n&gt;</b>	<p data-bbox="352 801 794 831"><u>Extended MNP functions (MNP 10)</u></p> <p data-bbox="352 851 1409 920">This command determines if a V.42LAP-M connection can be switched to a MNP 10 connection</p> <p data-bbox="352 940 1251 969"><b>AT-K0</b>            Disables switching from V.42 LAP-M to MNP 10 (default)</p> <p data-bbox="352 990 1134 1019"><b>AT-K1</b>            Enables switching from V.42 LAP-M to MNP 10</p>

Command	Description
<b>AT\K</b>	<p data-bbox="352 248 523 277"><u>Break control</u></p> <p data-bbox="352 293 1430 405">The Pocket Modem 56k 3.1 reacts to a break (receive path OFF for a certain amount of time), which it receives from another modem or from the PC, or from the command <b>AT\B</b> according to the parameters.</p> <p data-bbox="352 427 1430 495"><b>1. Situation</b> In case of a break from the application during the data connection to another modem:</p> <p data-bbox="352 510 1430 577"><b>AT\K0</b> Pocket Modem 56k 3.1 enters the command mode and sends no break to the other modem</p> <p data-bbox="352 593 1430 660"><b>AT\K1</b> Pocket Modem 56k 3.1 deletes the data buffer and sends a break to the other modem</p> <p data-bbox="352 676 676 705"><b>AT\K2</b> See <b>AT\K1</b></p> <p data-bbox="352 721 1430 788"><b>AT\K3</b> Pocket Modem 56k 3.1 immediately sends break to the other modem; data buffers are not deleted.</p> <p data-bbox="352 804 676 833"><b>AT\K4</b> See <b>AT\K0</b></p> <p data-bbox="352 848 1430 916"><b>AT\K5</b> Pocket Modem 56k 3.1 inserts break into the data transmitted to the other modem</p> <p data-bbox="352 938 1430 1084"><b>2. Situation</b> During a data connection, the Pocket Modem 56k 3.1 was set to command mode by an escape sequence +++. In this condition, the command <b>AT\B</b> will send a break to the other modem. In this situation, the parameter n will cause the following:</p> <p data-bbox="352 1099 1430 1167"><b>AT\K0</b> Pocket Modem 56k 3.1 deletes the data buffer and sends a break to the other modem</p> <p data-bbox="352 1182 676 1211"><b>AT\K1</b> See <b>AT\K0</b></p> <p data-bbox="352 1227 1430 1294"><b>AT\K2</b> Pocket Modem 56k 3.1 sends a break to the other modem without delay.</p> <p data-bbox="352 1310 676 1339"><b>AT\K3</b> See <b>AT\K2</b></p> <p data-bbox="352 1355 1430 1422"><b>AT\K4</b> Pocket Modem 56k 3.1 inserts a break into the data transmitted to the other modem</p> <p data-bbox="352 1438 1430 1505"><b>AT\K5</b> See <b>AT\K4</b> – Return from the online command mode into the data mode via the <b>ATO</b> command.</p> <p data-bbox="352 1527 1430 1628"><b>3. Situation</b> In the case a break is received from another modem during a connection that has not been error corrected, the parameters cause the following:</p> <p data-bbox="352 1644 1430 1711"><b>AT\K0</b> Pocket Modem 56k 3.1 deletes the data buffer and sends a break to the PC</p> <p data-bbox="352 1727 676 1756"><b>AT\K1</b> See <b>AT\K0</b></p> <p data-bbox="352 1771 1430 1800"><b>AT\K2</b> Pocket Modem 56k 3.1 sends a break to the PC without delay</p> <p data-bbox="352 1816 676 1845"><b>AT\K3</b> See <b>AT\K2</b></p> <p data-bbox="352 1861 1430 1962"><b>AT\K4</b> Pocket Modem 56k 3.1 sends a break to the application, which is embedded into the data that was received from the other Pocket Modem 56k 3.1</p> <p data-bbox="352 1977 676 2007"><b>AT\K5</b> See <b>AT\K4</b></p>

Command	Description
<b>ATL&lt;n&gt;</b>	<p><u>Speaker volume</u></p> <p>This command regulates the speaker volume (see command <b>ATM</b>).</p> <p><b>ATL1</b>            Speaker volume low (default)</p> <p><b>ATL2</b>            Speaker volume medium</p> <p><b>ATL3</b>            Speaker volume high</p>
<b>AT%L</b>	<p><u>Display level of the received signal</u></p> <p>The value that is reported from the Pocket Modem 56k 3.1 equals the already amplified level within the Pocket Modem 56k 3.1, not the phone line level.</p> <p>Large <b>AT%L</b> responses imply a low signal level; small values imply a high signal level (009 = -9db, 043 = -43db)</p>
<b>AT*L&lt;n&gt;</b>	<p><u>Determines the automatic speed limitation</u></p> <p>The automatic speed limitation is used to automatically achieve the least possible error rate for connections without error correction.</p> <p>In the factory settings the speed limitation is always switched on (<b>AT*L0</b>).</p> <p>If the limitation is switched off (<b>AT*L1</b>), the Pocket Modem 56k 3.1 will always establish the connection on the phone side with the maximum possible speed (or the speed defined with <b>AT+MS</b>), irrespective of the data rate at the serial interface. This means that the INSYS Modem 336 will, for example, always attempt to establish a 33600 baud connection, even if the serial interface is only set to 9600 baud. Without error correction the high speed will obviously lead to higher bit error rates, which is usually disruptive.</p> <p>The automatic speed limitation (<b>AT*L0</b>) will limit the speed on the phone side to the speed of the serial interface.</p> <p>It should only be switched off if very low baud rates are employed or if the speed of the serial interface is changed during the connection.</p>
<b>ATM&lt;n&gt;</b>	<p><u>Speaker control</u></p> <p>This command regulates when the speaker is active (see command <b>ATL&lt;n&gt;</b>).</p> <p><b>ATM0</b>            Speaker always OFF</p> <p><b>ATM1</b>            Speaker ON during dialing and connection setup (default)</p> <p><b>ATM2</b>            Speaker always ON</p> <p><b>ATM3</b>            Speaker on during connection setup</p>

Command	Description																					
<b>AT+MR=&lt;n&gt;</b>	<p><u>Show modulation type</u></p> <p>The command <b>AT+MR=&lt;n&gt;</b> enables the display of the modulation type after the message <b>CONNECT</b></p> <p><b>AT+MR=0</b> Switches the display function OFF (default).</p> <p><b>AT+MR=1</b> Switches the display function ON. The displayed value applies to the sent data.</p> <p><b>AT+MR=2</b> Switches the display function ON. The displayed value applies to the received data.</p> <p>If the display function is switched on the Pocket Modem 56k 3.1 will display the modulation type and the line speed after the message <b>CONNECT</b>. After the message <b>CONNECT</b>, the line „<b>+MCR:</b>” appears, followed by the modulation type (see command <b>AT+MS</b>) and the line „<b>+MRR:</b>”, followed by the line speed.</p> <p><b>Note:</b>           <b>The AT+MR command is useful for a connection check.</b></p>																					
<b>AT+MS=&lt;Modulation&gt;, [Automode], [Send Minbaud, Send Maxbaud], [Receive Minbaud, Receive Maxbaud]</b>	<p><u>Select modulation type</u></p> <p><b>AT+MS</b> determines the modulation type. The command enables or disables automatic modulation recognition and defines the highest and lowest possible connection speed. The command has the format <b>AT+MS=&lt;Modulation&gt;, [Automode], [Send Minbaud, Send Maxbaud], [Receive Minbaud, Receive Maxbaud]</b></p> <p><b>AT+MS?</b> Shows the current setting</p> <p><b>AT+MS=?</b> Displays a list of possible parameters</p> <p><b>Parameter modulation:</b></p> <p>The modulation parameter determines the preferred (automode = 1) or the mandatory (automode = 0) modulation type.</p> <p>The following values are available:</p> <table> <tbody> <tr> <td>V21</td> <td>V.21</td> <td>300</td> </tr> <tr> <td>V22</td> <td>V.22</td> <td>1200</td> </tr> <tr> <td>V22B</td> <td>V.22bis</td> <td>2400 or 1200</td> </tr> <tr> <td>V23C</td> <td>V.23</td> <td>1200</td> </tr> <tr> <td>V32</td> <td>V.32</td> <td>9600 or 4800</td> </tr> <tr> <td>V32B</td> <td>V.32bis</td> <td>14400, 12000, 9600, 7200 or 4800</td> </tr> <tr> <td>V34</td> <td>V.34</td> <td>33600, 31200, 28800, 26400, 24000, 21600, 19200, 16800, 14400, 12000, 9600, 7200, 4800 or 2400</td> </tr> </tbody> </table>	V21	V.21	300	V22	V.22	1200	V22B	V.22bis	2400 or 1200	V23C	V.23	1200	V32	V.32	9600 or 4800	V32B	V.32bis	14400, 12000, 9600, 7200 or 4800	V34	V.34	33600, 31200, 28800, 26400, 24000, 21600, 19200, 16800, 14400, 12000, 9600, 7200, 4800 or 2400
V21	V.21	300																				
V22	V.22	1200																				
V22B	V.22bis	2400 or 1200																				
V23C	V.23	1200																				
V32	V.32	9600 or 4800																				
V32B	V.32bis	14400, 12000, 9600, 7200 or 4800																				
V34	V.34	33600, 31200, 28800, 26400, 24000, 21600, 19200, 16800, 14400, 12000, 9600, 7200, 4800 or 2400																				

Command	Description						
<b>AT+MS=&lt;Modulation&gt;, [Automode], [Send Minbaud, Send Maxbaud], [Receive Minbaud, Receive Maxbaud]</b> <i>(continued)</i>	V90  V92	V.90  V.92	56000, 54667, 53333, 52000, 50667, 49333, 48000, 46667, 48000, 46667, 45333, 42667, 41333, 40000, 38667, 37333, 36000, 34667, 33333, 32000, 30667, 29333, 28000				
	B103	Bell 103	300				
	B212	Bell 212	1200/75				
<b>Parameter Automode:</b>							
The optional parameter automode determines whether the Pocket Modem 56k 3.1 automatically adjusts to the desired modulation type. The following values may be used:							
<table border="0"> <tr> <td style="padding-right: 40px;">0</td> <td>Automatic modulation adjustment switched off</td> </tr> <tr> <td>1</td> <td>Automatic modulation adjustment switched on</td> </tr> </table>				0	Automatic modulation adjustment switched off	1	Automatic modulation adjustment switched on
0	Automatic modulation adjustment switched off						
1	Automatic modulation adjustment switched on						
<b>Parameter Reception Minbaud:</b>							
The optional parameter minbaud determines the lowest possible baud rate for Pocket Modem 56k 3.1 reception.							
<b>Parameter Reception Maxbaud:</b>							
The optional parameter maxbaud determines the highest possible baud rate for Pocket Modem 56k 3.1 reception.							
<b>Parameter Send Minbaud:</b>							
The optional parameter minbaud determines the lowest possible baud rate which the Pocket Modem 56k 3.1 uses for sending.							
<b>Parameter Send Maxbaud:</b>							
The optional parameter maxbaud determines the highest possible baud rate which the Pocket Modem 56k 3.1 uses for sending.							







Command	Description
<b>AT*N&lt;n&gt;=&lt;nr&gt;</b> >	<p><u>Permitted numbers for selective call acceptance</u></p> <p>Definition of 8 authorized phone numbers, for which modem access is permitted. Only if the transmitted phone number matches a phone number that was entered in the list will the Pocket Modem 56k 3.1 report RING for an incoming call or will accept the call according to the settings of <b>ATS0</b> (the line RI is activated with each call, irrespective of that fact). <b>The selective call acceptance is switched on and off with AT&amp;A.</b></p> <p><b>AT*Nn=&lt;nr&gt;</b></p> <p><b>&lt;n&gt;</b> Describes the storage location – range of values: 0..7.</p> <p><b>&lt;no&gt;</b> Permitted phone number consists of numbers and the wild card "*" for exactly one character. The phone number may not contain separators such as brackets or space characters. After they were entered, the phone numbers are immediately saved in the power fail-safe memory of the Pocket Modem 56k 3.1.</p> <p><b>AT*N&lt;n&gt;=&lt;n1&gt;</b> The memory <b>N&lt;n&gt;</b> allows all phone numbers ending in <b>&lt;n1&gt;</b>.</p> <p><b>AT*N99=</b> Deletes all existing entries in the list</p> <p><b>AT*N?</b> Displays all stored entries</p> <p>Example: <b>AT*N5=1234</b> allows all calls ending with <b>1234</b>. E.g.: 0175/9991234, 0941/8881234, or +4940/7771234 <b>AT*N1=01234567**</b> permits all calls from the block of numbers 01234567-00 to 01234567-99</p>
<b>AT*N99</b>	<p><u>Delete the list of permitted phone numbers for the selective call answer</u></p> <p>The command <b>AT*N99=</b> deletes the entire list of phone numbers for the selective call answer.</p>
<b>AT*N?</b>	<p><u>Output of the list of permitted phone numbers</u></p> <p><b>AT*N?</b> activates the output of the entire saved list of permitted phone numbers for the selective call answer.</p>
<b>AT%N</b>	<p><u>Output of the last rejected phone number</u></p> <p>For active selective call answer (<b>AT&amp;A1</b>), the last phone number, whose call was rejected, will be displayed.</p> <p><b>Note: After it was entered, the phone number is not saved in the power fail-safe memory of the Pocket Modem 56k 3.1.</b></p>
<b>ATO&lt;n&gt;</b>	<p><u>Return to online data mode</u></p> <p>If the Pocket Modem 56k 3.1 is in online command mode, it will return to online data mode. If the Pocket Modem 56k 3.1 is in offline command mode, it will report <b>ERROR</b>.</p> <p><b>ATO0</b> Return to online data mode.</p> <p><b>ATO1</b> Before the modem switches to online data mode, a retrain procedure is provoked.</p>
<b>ATP</b>	<p><u>Switch on pulse dialing method (deactivated for some models)</u></p> <p>Starting with this command, each dial-up is performed with the pulse dialing method, until an <b>ATT</b> or <b>ATDT</b> command switches it back to tone dialing.</p>

Command	Description
<b>AT*P&lt;n&gt;</b>	<p><u>Password query</u></p> <p><b>AT*P0</b> Switches the password query off after the connection has been established. (default)</p> <p><b>AT*P1</b> Switches the password query on after the connection has been established.</p> <p>If the password query is activated, the Pocket Modem 56k 3.1 will query the password after <b>CONNECT</b> has taken place. After the password has been entered correctly, the actual <b>CONNECT</b> will take place and data may be transmitted. If a wrong password was entered, the Pocket Modem 56k 3.1 will hang up. The password is the same as for remote control and is set with <b>AT*C</b> .</p>
<b>ATQ&lt;n&gt;</b>	<p><u>Quiet control</u></p> <p>This command toggles sending messages from the Pocket Modem 56k 3.1 to the application ON and OFF.</p> <p><b>ATQ0</b> Send messages to application (default).</p> <p><b>ATQ1</b> Don't send messages to application.</p>
<b>AT%Q</b>	<p><u>Display telephone call quality</u></p> <p>Displays the quality of the data connection (deviation from the eye diagram). Low values indicate a good line quality. The line quality value must be evaluated differently depending on the negotiated data rate.</p> <p>Connections with more than 9600 baud will reach the value "000" for good lines and should not have values of more than "010".</p> <p>For connections with 33600 baud good lines will have values between 010...030. Depending on the settings and the modulation type a fall back or retrain is triggered if the line quality is too bad to enable a new negotiation of the connection (if necessary with a slower speed).</p> <p>High values indicate bad quality. These values are constantly updated during a connection. If the value increases significantly during a connection, the quality will deteriorate. After a previous <b>AT%E</b> command, an <i>Autoretrain</i> is performed.</p>

Command	Description
<b>AT\Q&lt;n&gt;</b>	<p><u>Quiet Call</u></p> <p>Quiet Call will switch of the phone connected in series at the first ring. In connection with the selective call answer (<b>AT&amp;N&lt;n&gt;</b>), calls from a previously defined phone number can take place without a ring of the phone connected in series. If the phone number is not detected by the Pocket Modem 56k 3.1, the phone is switched on again after the first ring.</p> <p><b>AT\Q0</b> Switches Quiet Call off (default)</p> <p><b>AT\Q1</b> Activates Quiet Call. The phone connected in series is disconnected, as soon as an entire ring signal cycle is detected on the line.</p> <p><b>AT\Q2</b> Activates Quiet Call. The phone connected in series is disconnected, as soon as a ring signal flank is detected on the line.</p> <p>The selection between the settings \Q1 or \Q2 depends on the circumstances at the phone connection. For \Q2 in connection with pulse dialing, phones that are connected in parallel will sometimes result in an erroneous detection of a ring signal flank. When using pulse dialing at the phones connected in series, <b>AT\Q1</b> must be used.</p>
<b>AT&amp;R&lt;n&gt;</b>	<p><u>RTS/ CTS behavior</u></p> <p>This command determines how the Pocket Modem 56k 3.1 treats the RTS/CTS (CT105/CT106) data flow control lines.</p> <p>(See also command <b>AT&amp;K</b>).</p> <p><b>AT&amp;R0</b> CTS behavior complies with V.25bis. CTS is deactivated during the connection setup after recognition of the response or ringing tones and will only be activated after the connection is set up. During the controlled half duplex operation (<b>AT&amp;K8</b>) CTS is active, if the Pocket Modem 56k 3.1 sends data at the serial interface. When data is received at the serial interface, CTS is inactive.</p> <p><b>AT&amp;R1</b> CTS only switches to OFF when this is required by the data flow control. During the controlled half duplex operation (<b>AT&amp;K8</b>) CTS is inactive, if the Pocket Modem 56k 3.1 sends data at the serial interface. When data is received at the serial interface, CTS is active. (default)</p>
<b>AT*R&lt;n&gt;</b>	<p><u>Switches the remote control on and off</u></p> <p><b>AT*R0</b> Switches the remote control OFF.</p> <p><b>AT*R1</b> Switches the remote control ON (default).</p>
<b>ATS&lt;n&gt;</b>	<p><u>Read/write of the S registry</u></p> <p>Depending on the country settings, the S registries may only be changed within certain limits. The Pocket Modem 56k 3.1 still reports <b>OK</b> although the value has not changed. We recommend checking the results after each write attempt, using the <b>ATS&lt;n&gt;?</b> command</p> <p><b>ATS&lt;n&gt;=&lt;x&gt;</b> Sets the S registry n to the value x.</p> <p><b>ATS&lt;n&gt;?</b> Shows the value of the S registry n.</p>

Command	Description
<b>AT%S&lt;n&gt;</b>	<p><u>Ability to switch between DCD and DSR lines</u></p> <p><b>AT%S0</b>      The DSR signal is on the DSR line The DCD signal is on the DCD line (default)</p> <p><b>AT%S1</b>      The DSR signal is on the DCD line The DCD signal is on the DSR line (Interchangeability of the lines)</p>
<b>AT&amp;S</b>	<p><u>DSR behavior</u></p> <p>This command determines how the Pocket Modem 56k 3.1 treats its DSR (CT107) output.</p> <p><b>AT&amp;S0</b>      DSR always ON (default).</p> <p><b>AT&amp;S1</b>      DSR ON after a response tone has been detected; DSR OFF when no carrier is detected any more.</p>
<b>AT*S&lt;n&gt;</b>	<p><u>Selects the transmission speed at the serial interface.</u></p> <p>The settings can be selected with this command. This will, however, not switch off the automatic detection. As soon as an <b>AT</b> is recognized, the serial interface will set itself to the recognized speed and protocol.</p> <p>If no <b>AT</b> is sent, the selected speed is maintained until a hardware reset is performed. If the selected speed should be maintained longer, it must be stored with <b>AT&amp;W</b>.</p> <p> <b>This command will not change the registry S23! It only changes if the automatic speed detection is used.</b></p> <p><b>AT*S0</b>      Maintaining the current speed.</p> <p><b>AT*S1</b>      300 bps</p> <p><b>AT*S2</b>      600 bps</p> <p><b>AT*S3</b>      1,200 bps</p> <p><b>AT*S4</b>      2,400 bps</p> <p><b>AT*S5</b>      4,800 bps</p> <p><b>AT*S6</b>      9,600 bps</p> <p><b>AT*S7</b>      19,200 bps</p> <p><b>AT*S8</b>      38,400 bps</p> <p><b>AT*S9</b>      57,600 bps</p> <p><b>AT*S10</b>     115,200 bps</p>

Command	Description																																													
<b>AT-STE=&lt;n&gt;</b>	<p><u>Priority circuit for Pocket Modem 56k 3.1 with phone connected in series</u></p> <p>The Pocket Modem 56k 3.1 gives a phone connected in series priority, to make sure it interferes as little as possible with the usage of the phone connection.</p> <p><b>Monitoring Functions:</b></p> <p>1) <b>Detecting a busy phone line</b>                      During a dial-up attempt, the Pocket Modem 56k 3.1 detects the busy phone line. (<b>LINE IN USE</b>).</p> <p>2) <b>Going off-hook on account of a telephone connected in series</b>                      If a telephone connected in series goes off-hook during an existing Pocket Modem 56k 3.1 connection, the Pocket Modem 56k 3.1 will immediately terminate the connection.                      The telephone is connected to the line and receives a dialing tone.</p> <p>3) <b>Remote terminal connection abort</b>                      When the remote terminal aborts a connection, the modem will immediately hang up.</p> <table border="1" data-bbox="354 1003 1433 1361"> <thead> <tr> <th>Command</th> <th>Function 1</th> <th>Function 2</th> <th>Function 3</th> <th></th> </tr> </thead> <tbody> <tr> <td><b>AT-STE=0</b></td> <td>--</td> <td>--</td> <td>--</td> <td>(default)</td> </tr> <tr> <td><b>AT-STE=1</b></td> <td>√</td> <td>--</td> <td>--</td> <td></td> </tr> <tr> <td><b>AT-STE=2</b></td> <td>--</td> <td>√</td> <td>--</td> <td></td> </tr> <tr> <td><b>AT-STE=3</b></td> <td>√</td> <td>√</td> <td>--</td> <td></td> </tr> <tr> <td><b>AT-STE=4</b></td> <td>--</td> <td>--</td> <td>√</td> <td></td> </tr> <tr> <td><b>AT-STE=5</b></td> <td>√</td> <td>--</td> <td>√</td> <td></td> </tr> <tr> <td><b>AT-STE=6</b></td> <td>--</td> <td>√</td> <td>√</td> <td></td> </tr> <tr> <td><b>AT-STE=7</b></td> <td>√</td> <td>√</td> <td>√</td> <td></td> </tr> </tbody> </table>	Command	Function 1	Function 2	Function 3		<b>AT-STE=0</b>	--	--	--	(default)	<b>AT-STE=1</b>	√	--	--		<b>AT-STE=2</b>	--	√	--		<b>AT-STE=3</b>	√	√	--		<b>AT-STE=4</b>	--	--	√		<b>AT-STE=5</b>	√	--	√		<b>AT-STE=6</b>	--	√	√		<b>AT-STE=7</b>	√	√	√	
Command	Function 1	Function 2	Function 3																																											
<b>AT-STE=0</b>	--	--	--	(default)																																										
<b>AT-STE=1</b>	√	--	--																																											
<b>AT-STE=2</b>	--	√	--																																											
<b>AT-STE=3</b>	√	√	--																																											
<b>AT-STE=4</b>	--	--	√																																											
<b>AT-STE=5</b>	√	--	√																																											
<b>AT-STE=6</b>	--	√	√																																											
<b>AT-STE=7</b>	√	√	√																																											
<b>ATT</b>	<p><u>Switching on tone dialing</u></p> <p>Starting with this command, each dial up is performed with the tone dialing method, until an <b>ATP</b> or <b>ATDP</b> command switches it back to pulse dialing.</p>																																													
<b>AT-TRV</b>	<p><u>Phone Line Voltage Measurement (Tip Ring Voltage)</u></p> <p>Use the command <b>AT-TRV</b> to measure the phone line voltage (Tip Ring Voltage). The result is yielded in volt. For an existing connection the voltage range will be 5V – 12V. Otherwise the voltage is higher than 20V. If the voltages are lower than 2V, no phone line is connected.</p>																																													

Command	Description																																
<b>AT-TTE=U1 , U2 , U3</b>	<p><u>Parameter configuration for priority circuit</u></p> <p>The command <b>AT-TTE=U1 , U2 , U3</b> will set the change of the loop voltage. The settings are required to detect <b>AT-STE=&lt;n&gt;</b>.</p> <p><b>U1</b>                    <b>Line busy</b> Factory setting: u1=1000 (10V)</p> <p><b>U2</b>                    <b>Going off-hook on account of a telephone connected in series</b> Factory setting: u2=100 (1V)</p> <p><b>U3</b>                    <b>Remote terminal connection abort</b> Factory setting: u3=500 (5V)</p> <p><b>These settings cannot be stored with AT&amp;W in the power fail-safe memory.</b></p>																																
<b>AT*U&lt;n&gt;</b>	<p><u>Select the data format at the serial interface</u></p> <p>The data format can be preselected with this command. This will, however, not switch off the automatic detection. As soon as an <b>AT</b> is recognized, the serial interface will set itself to the recognized speed and protocol.</p> <p>If no <b>AT</b> is sent, the selected protocol is maintained until a hardware reset is performed. If the selected protocol should be maintained longer, it must be stored with <b>AT&amp;W</b>.</p> <p>                    <b>This command will not change the registry S23! It only changes if the automatic speed and protocol detection is used.</b></p> <table> <tbody> <tr> <td><b>AT*U0</b></td> <td>8 data bits,</td> <td>no parity,</td> <td>1 stop bit</td> </tr> <tr> <td><b>AT*U1</b></td> <td>7 data bits,</td> <td>odd parity,</td> <td>1 stop bit</td> </tr> <tr> <td><b>AT*U2</b></td> <td>7 data bits,</td> <td>even parity,</td> <td>1 stop bit</td> </tr> <tr> <td><b>AT*U3</b></td> <td>7 data bits,</td> <td>no parity,</td> <td>1 stop bit</td> </tr> <tr> <td><b>AT*U6</b></td> <td>7 data bits,</td> <td>no parity,</td> <td>2 stop bits</td> </tr> <tr> <td><b>AT*U7</b></td> <td>8 data bits,</td> <td>odd parity,</td> <td>1 stop bit</td> </tr> <tr> <td><b>AT*U8</b></td> <td>8 data bits,</td> <td>even parity,</td> <td>1 stop bit</td> </tr> <tr> <td><b>AT*U9</b></td> <td>8 data bits,</td> <td>no parity,</td> <td>2 stop bits</td> </tr> </tbody> </table>	<b>AT*U0</b>	8 data bits,	no parity,	1 stop bit	<b>AT*U1</b>	7 data bits,	odd parity,	1 stop bit	<b>AT*U2</b>	7 data bits,	even parity,	1 stop bit	<b>AT*U3</b>	7 data bits,	no parity,	1 stop bit	<b>AT*U6</b>	7 data bits,	no parity,	2 stop bits	<b>AT*U7</b>	8 data bits,	odd parity,	1 stop bit	<b>AT*U8</b>	8 data bits,	even parity,	1 stop bit	<b>AT*U9</b>	8 data bits,	no parity,	2 stop bits
<b>AT*U0</b>	8 data bits,	no parity,	1 stop bit																														
<b>AT*U1</b>	7 data bits,	odd parity,	1 stop bit																														
<b>AT*U2</b>	7 data bits,	even parity,	1 stop bit																														
<b>AT*U3</b>	7 data bits,	no parity,	1 stop bit																														
<b>AT*U6</b>	7 data bits,	no parity,	2 stop bits																														
<b>AT*U7</b>	8 data bits,	odd parity,	1 stop bit																														
<b>AT*U8</b>	8 data bits,	even parity,	1 stop bit																														
<b>AT*U9</b>	8 data bits,	no parity,	2 stop bits																														
<b>ATV&lt;n&gt;</b>	<p><u>Format of modem messages</u></p> <p>This command determines if the Pocket Modem 56k 3.1 transmits messages to the application in short or long format.</p> <p><b>ATV0</b>                    Messages in short format, i.e. only the error number</p> <p><b>ATV1</b>                    Messages in long format, i.e. the error text (<i>default</i>)</p>																																
<b>AT\V&lt;n&gt;</b>	<p><u>Format of connect rate messages</u></p> <p><b>AT\V0</b>                    This command enables the display of the connect message in three lines.</p> <p><b>AT\V1</b>                    This command enables the display of the connect message in one-line. (default)</p>																																



Command	Description
<b>AT&amp;V&lt;n&gt;</b>	<p data-bbox="355 246 662 280"><u>Show the configurations</u></p> <p data-bbox="355 302 1396 403"><b>AT&amp;V0</b> The active configuration of the modem, the saved user defaults and the saved phone numbers 0 to 3 (the parameter 0 may be omitted) are displayed.</p> <p data-bbox="355 414 1396 481"><b>AT&amp;V1</b> Displays the diagnostic data of the last connection (connection partner, reason for disconnect).</p> <p data-bbox="502 504 1348 571"><b>TERMINATION REASON:</b> Reason for disconnect. E.g.: Connection termination via command (<b>ATH: "LOCAL REQUEST"</b>).</p> <p data-bbox="502 582 1404 638"><b>LAST TX rate:</b> Last baud rate at the phone line in send direction, prior to the termination.</p> <p data-bbox="502 660 1396 728"><b>HIGHEST TX rate:</b> Highest baud rate that was achieved at the phone line in send direction, prior to the termination.</p> <p data-bbox="502 739 1364 795"><b>LAST RX rate:</b> Last baud rate at the phone line in receive direction, prior to the termination.</p> <p data-bbox="502 806 1396 873"><b>HIGHEST RX rate:</b> Highest baud rate that was achieved at the phone line in receive direction, prior to the termination.</p> <p data-bbox="502 907 1404 996"><b>Note:</b> The data rates may vary if a fall forward, fall back or retrain occurred during the connection. To impact the negotiated data rate, use the command <b>AT+MS</b>.</p> <p data-bbox="502 1019 1404 1120"><b>PROTOCOL:</b> Displays the used error correction protocol. "<b>LAPM</b>" equals a V.42 secured connection. For "<b>NONE</b>", the connection was not error corrected (the error corrected can be influenced with the command <b>AT\N</b>).</p> <p data-bbox="502 1142 1404 1232"><b>COMPRESSION:</b> Displays the used data compression method. The example shows the used compression method V.42bis (the compression method can be set with the command <b>AT%C</b>).</p> <p data-bbox="502 1254 1396 1377"><b>LINE QUALITY:</b> Displays the quality of the data connection (deviation from the eye diagram). Low values indicate a good line quality. The line quality value must be evaluated differently depending on the negotiated data rate.</p> <p data-bbox="502 1400 1372 1467">Connections with more than 9600 baud will reach the value "000" for good lines and should not have values of more than "010".</p> <p data-bbox="502 1478 1420 1601">For connections with 33600 baud good lines will have values between 010...030. Depending on the settings and the modulation type a fall back or retrain is triggered if the line quality is too bad to enable a new negotiation of the connection (if necessary with a slower speed).</p> <p data-bbox="502 1624 1428 1780"><b>Rx LEVEL:</b> Displays the receive level (which is internally applied at the modem chip) in -dBm. High values indicate a low input level; low values indicate a high input level. The optimum receive levels range from approx. 012 to 028. Too high levels could cause distortions; too low levels will cause the line noise to have a negative impact on the connection quality.</p> <p data-bbox="502 1803 1388 1870"><b>Local Rtrn Count:</b> Number of retrains (renegotiation of the connection), triggered by the local modem.</p> <p data-bbox="502 1881 1404 1948"><b>Remote Rtrn Count:</b> Number of retrains (renegotiation of the connection), triggered by the remote modem.</p> <p data-bbox="355 1971 1396 2027"><b>AT&amp;V3</b> Display of the currently set baud rate (<b>AT*S&lt;n&gt;</b>) as well as the currently set data format (<b>AT*U&lt;n&gt;</b>).</p>



Command	Description
<b>AT+VCID=&lt;n&gt;</b>	<p><u>Set CLIP</u></p> <p>With this function, the phone number of the caller can be displayed during an incoming call.</p> <p>(Only for phone lines or systems that support CLIP. If you want to use the CLIP function, please ask your network provider, if your connection supports this function.</p> <p>The following countries support CLIP: Australia, Belgium, China, Denmark, Germany, Finland, Great Britain, Hong Kong, India, Ireland, Iceland, Italy, Canada, Korea, New Zealand, The Netherlands, Norway, Austria, Sweden, Singapore, Spain, Taiwan, USA).</p> <p><b>AT+VCID=0</b> Switches the CLIP function OFF (default).</p> <p><b>AT+VCID=1</b> Switches the CLIP function ON and displays the ID preformatted for calls.</p> <p><b>AT+VCID=2</b> Switches the CLIP function ON and displays the ID unformatted for calls.</p>
<b>AT+VRID=&lt;n&gt;</b>	<p><u>Set last received CLIP</u></p> <p>The command <b>AT+VRID</b> displays the CLIP of the last caller.</p> <p><b>AT+VRID=0</b> displays the ID preformatted.</p> <p><b>AT+VRID=1</b> displays the ID unformatted.</p>
<b>ATW&lt;n&gt;</b>	<p><u>Error correction messages</u></p> <p>This command determines which data transmission rate information is provided for a <b>CONNECT</b> message.</p> <p><b>ATW0</b> The Pocket Modem 56k 3.1 reports the baud rate between Pocket Modem 56k 3.1 and application. (default)</p> <p><b>ATW1</b> During the connection setup, the Pocket Modem 56k 3.1 reports the phone line speed, the error correction protocol and the application baud rate.</p> <p><b>ATW2</b> The Pocket Modem 56k 3.1 reports the phone line speed.</p>
<b>AT&amp;W&lt;n&gt;</b>	<p><u>Save configuration</u></p> <p>The command saves the current modem configuration including the S registry in one of the two user-defined defaults.</p> <p><b>AT&amp;W0</b> Save in user default 0</p> <p><b>AT&amp;W1</b> Save in user default 1</p>

Command	Description
<b>ATX&lt;n&gt;</b>	<p><u>Extended result messages, dial tone detection</u></p> <p>The command determines which group of messages the Pocket Modem 56k 3.1 sends to the PC. This is important for PBXs, as a leading 0 or 9 must often be dialed before a dialing tone is heard on the line. <i>Blind dialing</i> (dialing without detecting the dialing tone) is activated or deactivated according to the parameter. The detection of the dialing tone, however, can always be enforced using the parameter <b>W</b> in the <b>ATD</b> dialing string (see command <b>ATD</b>). In the mode <b>AT+FCLASS=1,2</b> the Pocket Modem 56k 3.1 always sends the message <b>CONNECT</b> to the PC without specifying the transmission speed.</p> <p><b>ATX0</b>            No detection of the dialing tone, i.e. an unsuccessful dialing attempt leads to the message <b>NO CARRIER</b>. No detection of the busy signal, i.e. when calling a busy line the message <b>NO CARRIER</b> is displayed. The message is displayed without specifying the speed.</p> <p><b>ATX1</b>            As <b>ATX0</b>, but the <b>CONNECT</b> message contains the speed specification.</p> <p><b>ATX2</b>            Dialing tone detection is active, i.e. a dialing attempt without the presence of a dialing tone leads to the message <b>NO DIALTONE</b>. No detection of the busy signal, i.e. when calling a busy line the message <b>NO CARRIER</b> is displayed.</p> <p><b>ATX3</b>            No detection of the dialing tone, i.e. an unsuccessful dialing attempt leads to the message <b>NO CARRIER</b>. Busy signal detection active, i.e. when calling a busy line the message <b>BUSY</b> is displayed.</p> <p><b>ATX4</b>            Dialing tone detection is active, i.e. a dialing attempt without the presence of a dialing tone leads to the message <b>NO DIALTONE</b>. (default) Busy signal detection is active, i.e. when calling a busy line the message <b>BUSY</b> is displayed.</p>
<b>AT*X</b>	<p><u>Terminate remote configuration</u></p> <p>The command <b>AT*X</b> terminates a remote configuration.</p>
<b>AT&amp;Y&lt;n&gt;</b>	<p><u>Selection of user configuration for hardware reset</u></p> <p><b>AT&amp;Y0</b>            For a hardware reset following the <b>AT&amp;Y0</b>-command, the user default 0 (created using the <b>AT&amp;W0</b> command) is loaded into the current modem configuration.</p> <p><b>AT&amp;Y1</b>            For a hardware reset following the <b>AT&amp;Y1</b>-command, the user default 1 (created using the <b>AT&amp;W1</b> command) is loaded into the current modem configuration.</p>
<b>ATZ&lt;n&gt;</b>	<p><u>Software reset</u></p> <p>The command causes the Pocket Modem 56k 3.1 to perform a software reset. The Pocket Modem 56k 3.1 will load the default saved by the user (according to the parameter). If no parameter is specified, the user default 0 is loaded.</p> <p><b>ATZ0</b>            Software reset; afterwards the user default 0 is loaded.</p> <p><b>ATZ1</b>            Software reset; afterwards the user default 1 is loaded.</p>



## 13.1 AT Messages

List of message numbers and messages texts depending on the command **ATX**.

Message Number Short form	Message text in long form	ATX<0>	ATX<1>	ATX<2>	ATX<3>	ATX<4>
+F4	+FCERROR	X	X	X	X	X
0	OK	X	X	X	X	X
1	CONNECT	X	X	X	X	X
2	RING	X	X	X	X	X
3	NO CARRIER	X	X	X	X	X
4	ERROR	X	X	X	X	X
5	CONNECT 1200	1	X	X	X	X
6	NO DIAL TONE	3	3	X	3	X
7	BUSY	3	3	3	X	X
8	NO ANSWER	1	X	X	X	X
9	CONNECT 600	1	X	X	X	X
10	CONNECT 2400	1	X	X	X	X
11	CONNECT 4800	1	X	X	X	X
12	CONNECT 9600	1	X	X	X	X
13	CONNECT 7200	1	X	X	X	X
14	CONNECT 12000	1	X	X	X	X
15	CONNECT 14400	1	X	X	X	X
16	CONNECT 19200	1	X	X	X	X
17	CONNECT 38400	1	X	X	X	X
18	CONNECT 57600	1	X	X	X	X
19	CONNECT 115200	1	X	X	X	X
20	CONNECT 230400	X	X	X	X	X
22	CONNECT 75TX/1200RX	1	X	X	X	X
23	CONNECT 1200TX/75RX	1	X	X	X	X
24	DELAYED	4	4	4	4	X
32	BLACKLISTED	4	4	4	4	X
33	FAX	X	X	X	X	X
35	DATA	X	X	X	X	X
40	CARRIER 300	X	X	X	X	X
44	CARRIER 1200/75	X	X	X	X	X
45	CARRIER 75/1200	X	X	X	X	X
46	CARRIER 1200	X	X	X	X	X
47	CARRIER 2400	X	X	X	X	X
48	CARRIER 4800	X	X	X	X	X
49	CARRIER 7200	X	X	X	X	X
50	CARRIER 9600	X	X	X	X	X

Message Number Short form	Message text in long form	ATX<0>	ATX<1>	ATX<2>	ATX<3>	ATX<4>
51	CARRIER 12000	X	X	X	X	X
52	CARRIER 14400	X	X	X	X	X
53	CARRIER 16800	X	X	X	X	X
54	CARRIER 19200	X	X	X	X	X
55	CARRIER 21600	X	X	X	X	X
56	CARRIER 24000	X	X	X	X	X
57	CARRIER 26400	X	X	X	X	X
58	CARRIER 28800	X	X	X	X	X
59	CONNECT 16800	1	X	X	X	X
61	CONNECT 21600	1	X	X	X	X
62	CONNECT 24000	1	X	X	X	X
63	CONNECT 26400	1	X	X	X	X
64	CONNECT 28800	1	X	X	X	X
66	COMPRESSION: CLASS 5	X	X	X	X	X
67	COMPRESSION: V.42 bis	X	X	X	X	X
69	COMPRESSION: NONE	X	X	X	X	X
70	PROTOCOL: NONE	X	X	X	X	X
77	PROTOCOL: LAP-M	X	X	X	X	X
78	CARRIER 31200	X	X	X	X	X
79	CARRIER 33600	X	X	X	X	X
80	PROTOCOL: ALT	X	X	X	X	X
81	PROTOCOL: ALT- CELLULAR	X	X	X	X	X
84	CONNECT 33600	X	X	X	X	X
91	CONNECT 31200	X	X	X	X	X
150	CARRIER 32000	X	X	X	X	X
151	CARRIER 34000	X	X	X	X	X
152	CARRIER 36000	X	X	X	X	X
153	CARRIER 38000	X	X	X	X	X
154	CARRIER 40000	X	X	X	X	X
155	CARRIER 42000	X	X	X	X	X
156	CARRIER 44000	X	X	X	X	X
157	CARRIER 46000	X	X	X	X	X
158	CARRIER 48000	X	X	X	X	X
159	CARRIER 50000	X	X	X	X	X
160	CARRIER 52000	X	X	X	X	X
161	CARRIER 54000	X	X	X	X	X
162	CARRIER 56000	X	X	X	X	X
165	CONNECT 32000	X	X	X	X	X
166	CONNECT 34000	X	X	X	X	X
167	CONNECT 36000	X	X	X	X	X

Message Number Short form	Message text in long form	ATX<0>	ATX<1>	ATX<2>	ATX<3>	ATX<4>
168	CONNECT 38000	X	X	X	X	X
169	CONNECT 40000	X	X	X	X	X
170	CONNECT 42000	X	X	X	X	X
171	CONNECT 44000	X	X	X	X	X
172	CONNECT 46000	X	X	X	X	X
173	CONNECT 48000	X	X	X	X	X
174	CONNECT 50000	X	X	X	X	X
175	CONNECT 52000	X	X	X	X	X
176	CONNECT 54000	X	X	X	X	X
177	CONNECT 56000	X	X	X	X	X
178	CONNECT 230400	X	X	X	X	X
180	CARRIER 28000	X	X	X	X	X
181	CARRIER 29333	X	X	X	X	X
182	CARRIER 30667	X	X	X	X	X
183	CARRIER 33333	X	X	X	X	X
184	CARRIER 34667	X	X	X	X	X
185	CARRIER 37333	X	X	X	X	X
186	CARRIER 38667	X	X	X	X	X
187	CARRIER 41333	X	X	X	X	X
188	CARRIER 42667	X	X	X	X	X
189	CARRIER 45333	X	X	X	X	X
190	CARRIER 46667	X	X	X	X	X
191	CARRIER 49333	X	X	X	X	X
192	CARRIER 50667	X	X	X	X	X
193	CARRIER 53333	X	X	X	X	X
194	CARRIER 54667	X	X	X	X	X

Table 7: AT responses depending on the ATX command

**Notes regarding the table:**

An **X** in the column indicates that a message is either sent in long or short form (depending on the **ATV** command). In the topmost line, the characters 0 to 4 each indicate the parameters for the commands **ATX0** to **ATX4**.

If there is a number in a column, this indicates that an error message is displayed according to the error number.

S registries may be read and written using the **ATS<n>** command. (See Chapter 1, command **ATS<n>**) Certain S registries may only be read; into others only a particular range of values may be entered.

If the range of values is exceeded, the modem will report **OK**, although the value was not accepted. We therefore recommend to immediately check modifications by reading (**ATS<n>?**).

## 14 Country Codes

Adjust the modem to local requirements using the command **AT+GCI=<countrycode>**

All other settings should be carried out **after** the country code has been selected, because some factory settings depend on the country.

Country	Code
Europe TBR21*)	FD (default)
Egypt	36
Ethiopia	FE
Albania	B8
Algeria	FE
Andorra	FD
Argentina	07
Australia	09
Bangladesh	FE
Belgium*	FD/0F
Belize	FE
Benin	FE
Burma (Myanmar)	FE
Bolivia	FE
Bosnia Herzegovina	FE
Brazil	16
Brunei	FE
Bulgaria	1B
Chile	25
China	26
Costa Rica	FE
Denmark*	FD/31
Germany	FD/42
Dominican Republic	33
Ecuador	FE
Ivory Coast	FE
El Salvador	FE
Estonia	F9
Finland*	FD/3C
France*	FD/3D
Gabon	3D
Ghana	FE
Greece*	FD/46
Greenland	31
Great Britain*	FD/B4

Country	Code
Guatemala	FE
Honduras	FE
Hong Kong	50
India	53
Indonesia	54
Ireland*	FD/57
Iceland*	FD/52
Israel	58
Italy*	FD/59
ITU/Taiwan	FE
Jamaica	B4
Japan	00
Yemen	FE
Jordan	FE
Cambodia	FE
Cameroon	3D
Canada	20
Kazakhstan	B8
Qatar	98
Kenya	B4
Colombia	27
Republic of Korea	61
Croatia	FA
Kuwait	62
Laos	FE
Latvia	FD
Lebanon	64
Liechtenstein*	FD
Lithuania	FE
Luxembourg*	FD/69
Madagascar	FE
Malawi	B4
Malaysia	6C
Malta	B4
Mauritania	FE
Mauritius	B4
Macedonia	FE
Mexico	73
Monaco	FD
Moldavia	B8
Montenegro	FE
New Zealand	7E
Nicaragua	FE



Country	Code
Netherlands*	FD/7B
Niger	3D
Nigeria	81
Norway*	FD/82
Oman	FE
Austria*	FD/0A
Pakistan	84
Panama	85
Paraguay	87
Peru	FE
Philippines	89
Poland	8A
Portugal*	FD/8B
Reunion	3D
Romania	8E
Russian Federation	B8
San Marino*	FD
Zambia	FE
Saudi Arabia	98
Sweden*	FD/A5
Switzerland	FD/A6*
Senegal	99
Serbia	FE
Singapore	9C
Zimbabwe	B4
Slovak Republic	FB
Slovenia	FC
Spain*	FD/A0
Sri Lanka	A1
South Africa	9F
Taiwan	FE
Tanzania	B4
Thailand	A9
Czech Republic	2E
Turkey	AE
Tunisia	FE
Uganda	B4
Ukraine	FE
Hungary	51
Uruguay	B7
USA	B5
Venezuela	BB
United Arab Emirates	B3

Country	Code
Belarus	FE
Cyprus	2D

**Table 8: Country codes to adjust the local requirements**

\*) The standard TBR21 applies to all public phone networks in EU countries (Belgium, Denmark, German, Finland, France, Greece, Great Britain, Ireland, Italy, Luxembourg, Netherlands, Austria, Portugal, Sweden, Spain), as well as in Switzerland, Liechtenstein, Norway and Iceland. Only old telecommunications systems require the individual country to be set explicitly.

## 15 S Registry

S registries may be read and written using the **ATS<n>** command. (see also AT Command Reference). Certain S registries may only be read; into others only a particular range of values may be entered.

If the range of values is exceeded, the modem will report **OK**, although the value was not accepted. We therefore recommend to immediately check modifications by reading (**ATS<n>?**).

### Note:

- \* These registries are stored in the user defaults with **AT&W0** or **AT&W1**.
- \*\* The defaults can differ depending on the set country code.

### 15.1 Overview S Registry

Tab	Function	Units	Range	Default
S0*	Number of ringing tones until automatically going off-hook	Ringing tones	0-5	5
S1	Ringing tone counter	Ringing tones	0-255	0
S2*	Escape	ASCII	0-255	43
S3	Return	ASCII	0-127	13
S4	Linefeed character	ASCII	0-127	10
S5	Backspace character	ASCII	0-255	8
S6*	Waiting period dial tone	s	3-7	3
S7*	Waiting period carrier signal	s	0-100	50
S8*	Dial tone delay	s	1-7	2
S9*	Reaction time carrier signal	0.1 s	1-255	6
S10*	Time period between lost carrier signal and hang up	0.1 s	14-254	14
S12*	Transmission clock of the ESC characters	0.02 s	0-255	50
S13*	Number of dialing attempts to send the message		1-12	3
S14*	General settings			146
S15*	Data Transmit Controller DTC	1s	0-255	0
S17*	Initial character for remote configuration		0-127	42
S21*	Settings for V24			52
S22*	Settings			117
S24*	Time period until switching into sleep mode	s	0-255	0
S25	Time period for DTR signal	0.01 s	0-255	5
S26	Time period between RTS/CTS	0.01 s	0-255	1

Tab	Function	Units	Range	Default
S27*	General settings	-		137
S29	Time period for modifier "flash"	10 ms	0-17	0
S30	Time period until hang up due to silence	10 s	0-255	0
S31*	General settings	-		192
S36*	Reset of error logs	-		135
S38	Time period until forced hang up	s	0-255	20
S39*	Flow control	-		3
S40*	General settings	-		104
S41*	General settings	-		195
S46*	Data compression	-		138
S48*	Setting for V42 declaration phase	-		7
S86	Error event code	-		Read-only
S91*	Transmit Level	-	0-15	14
S95*	Result code	-		0

**Table 9: Overview S Registry: Units, value range, presets**

## 15.2 Description S Registry

**Note:** Registries marked with \*) are stored in the user defaults with the command **AT&W**.

- S0\*** Number of ringing tones until automatically going off-hook  
Number of rings until the modem goes off-hook  
For S0=0 the modem will not go off-hook when a call comes in. The value of S0 can be between 0 and 5.
- S1** Ringing tone counter  
Counter for call ringing. S1 is read-only. S1 will be reset to zero, when the modem answers a call.
- S2\*** Escape  
Escape character which causes a switch from data mode to online command input mode. Values larger than 127 will lead to the fact that no ESC character will be recognized.
- S3** Return  
Carriage Return Character (CR).
- S3** Linefeed character  
Linefeed character
- S5** Backspace character  
Backspace character
- S6\*** Waiting period dial tone  
Maximum waiting time for the dialing tone. After the modem went off-hook it waits 7 seconds for the dialing tone (fixed for approval purposes). If it detects a dialing tone during this waiting period it will start dialing.  
If it does not detect a dialing tone, it will check if dial tone recognition is activated or if the dialing string (Chapter „AT Command Set“, command **ATD**) contains the parameter **W**. If the dialing tone detection is not activated, the modem waits for the dialing tone. The waiting time (in seconds) is specified in S6.  
The value of the S6 registry can be between 4 and 7 seconds.
- S7\*** Waiting period carrier signal  
Wait for the carrier frequency from the other modem. The maximum time for the modem to wait for a response from the other modem is specified in S7. The time starts running as soon as the modem has finished dialing. The value of S7 can be between 0 and 180 seconds.

**S8\*** Dial tone delay

Dial pause time, if a comma is included in the dialing string. If there is a comma in the dialing string, the modem will wait during the dialing procedure, until the time specified in S8 (in seconds) has run out. The value of S8 can be between 1 and 7 seconds.

**S9\*** Reaction time carrier signal

DCD response time for the carrier frequency from the other modem. The DCD output of the RS232 interface (CT109) of the modem switches to ON, when the carrier frequency from the other modem is detected before the time defined in S9 (in tenth of seconds) runs out. S9 must be smaller than S10.

**S10\*** Time period between lost carrier signal and hang up

The time which leads to termination after carrier frequency loss. In S10, the time period for which the modem waits for the disconnection if it can no longer detect the carrier frequency from the other modem, is specified in tenth of seconds.

**S12\*** Transmission clock of the ESC characters

Minimum pre and post run time and maximum interim time in 1/50 of seconds between two characters. This must be observed, if the modem is supposed to detect an abort sequence (usually +++).

**S13\*** Number of dialing attempts to send a message

Bit	Meaning	
Bit 0 – 3	Number of dialing attempts	Range of values: 1...12 Default value: 3 S13 determines the number of attempts to send the message. <b>Note:</b> The limitation to a maximum of 12 attempts is necessary for approval purposes (black listing).
Bit 4 - 7	Reserved	

**S14\*** General settings

Bit	Meaning		
Bit 0	Reserved		
Bit 1	Echo on inputs	Command echo	0: Echo off 1: Echo on
Bit 2	Reserved		
Bit 3	Result format	Result codes:	0: Message numbers ( <b>ATV0</b> ) 1: Message texts ( <b>ATV1</b> )
Bit 4	Reserved		
Bit 5	Tone/pulse dialing	Tone/pulse	0: Tone dialing ( <b>ATT</b> ) 1: Pulse dialing ( <b>ATP</b> )
Bit 6	Reserved		
Bit 7	Originate/answer	Originate/answer	0: Answer mode 1: Originate mode

**S15\*** DTC Time Settings

The idle connection control is a function integrated in the firmware which monitors the data transmission in online mode. This function prevents the modem to stay online for an unlimited amount of time, although no data is being transmitted anymore.

In the registry S15, any time period between 1 and 255 seconds may be entered. If S15 is set to 0, the idle connection control is switched off.

The timer will run immediately after the modem goes off-hook. As soon as the timer has run out, a modem reset is performed (which will forcibly lead to the hanging up of the modem).

**S17\*** Initial character for remote configuration

In S17, the ASCII code of a character which is used to start the remote configuration, is defined. Values >127 switch the remote configuration off completely. The default setting in S17 is "42", which equals the ASCII character "\*". This means that the remote configuration is started with the Escape character sequence

**<Pause> \*\*\*\* <Pause>.**

**Note:** The number of characters in the Escape sequence is fixed to "4" characters).

**S21\*** Settings for V24

Bit	Meaning	
Bit 0.1	Reserved	
Bit 2	CTS behaviour	CT106 (CTS) behaviour: 0: see <b>AT\K0</b> 1: see <b>AT&amp;R1</b>
Bit 3-4	DTR behaviour	CT108 (DTR) behaviour: 0: see <b>AT&amp;D0</b> 1: see <b>AT&amp;D1</b> 2: see <b>AT&amp;D2</b> 3: see <b>AT&amp;D3</b>
Bit 5	DCD behaviour	CT109 (DCD) behaviour: 0: see <b>AT&amp;C0</b> 1: see <b>AT&amp;C1</b>
Bit 6	DSR behaviour	CT107 (DCD) behaviour: 0: see <b>AT&amp;S0</b> 1: see <b>AT&amp;S1</b>
Bit 7	Reserved	Reserved

**S22\*** Speaker system settings

Bit	Meaning	
Bit 0.1	Speaker volume	Speaker volume: 0: Off ( <b>ATL0</b> ) 1: Silent ( <b>ATL1</b> ) 2: Medium ( <b>ATL2</b> ) 3: Loud ( <b>ATL3</b> )
Bit 2-3	Speaker control	Speaker control: 0: Off ( <b>ATM0</b> ) 1: On until carrier ( <b>ATM1</b> ) 2: Always on ( <b>ATM2</b> ) 3: On at establishing
Bit 4-6	Error message group	Limit result codes: 0: see <b>ATX0</b> 4: see <b>ATX1</b> 5: see <b>ATX2</b> 6: see <b>ATX3</b> 7: see <b>ATX4</b>
Bit 7	Stores the setting of <b>AT*L</b>	

**S24\*** Time period until switching into sleep mode

The time after which the modem switches to energy saving mode (sleep) during inactivity is determined (in seconds) in S24. The energy saving mode will be quit as soon as characters are sent to the modem, or when a call comes in.

**Note:** When the modem is in sleep mode, it is necessary to send an "AT" command before sending other commands. This first "AT" command may not be answered with "OK". Further AT com-

mands may be entered immediately.



**S25** Time period for DTR signal

Time period, in which a modem waits without a DTR signal before it hangs up (1/100 seconds).

**S26** Time period between RTS/CTS

Time period between RTS and CTS activation in 1/100 seconds.

**S27\*** General settings

Bit	Meaning	
Bit 0-3	RS232-Mode	Asynchronous Mode Selection: 0: see <b>AT&amp;M0</b> or <b>AT&amp;Q0</b> 9: see <b>AT&amp;Q5</b> 10: see <b>AT&amp;Q6</b>
Bit 4.5	Reserved	
Bit 6	CCITT or Bell Modulation	CCITT/Bell Select 0: CCITT Modulation 1: Bell Modulation
Bit 7	Remote Control Status	Remote control 0: Remote control OFF 1: Remote control ON

**S29** Time period for modifier “flash”

Sets the time period in tenths of seconds, after which the modem hangs up due to a flash in the dialing string.

**S30** Time period until hang up due to silence

Time period, in which the modem waits without activity before hanging up. Units in seconds (only for FAX Class 1).

**S31\*** General settings

Bit	Meaning	
Bit 0	Reserved	
Bit 1	Description Connect message	0: 3-line message ( <b>\v0</b> ) 1: Expanded 1-line message ( <b>\v1</b> )
Bit 2-3	Error correction Messages	Messages: 0: Only PC baud rate 1: PC and phone baud rate ( <b>ATW1</b> ) 2: Only phone baud rate ( <b>ATW2</b> )
Bit 4-7	Reserved	

**S36\*** Reset of error logs

Bit	Meaning	
Bit 0..2	Determines what happens if an attempt to establish a V.42 LAP-M connection fails. It is connected to the registry S48.	0 Modem hangs up 1 Modem stays online and establishes a direct mode connection. 2 Reserved 3 Modem stays online and establishes a direct mode connection. 4 Modem attempts to establish a MNP connection. In case of failure it hangs up. 5 Modem attempts to establish a MNP connection. In case of failure a direct mode connection is established. 6 Reserved 7 Modem attempts to establish a MNP connection. In case of failure a normal mode connection is established.
Bit 3.0.5	SMS type	0: normal fixed network modem ( <b>AT*M0</b> ) 1: D1 and E networks ( <b>AT*M1</b> ) 4: D2 network ( <b>AT*M4</b> ) 5: Fax ( <b>AT*M5</b> ) 6: Fixed network SMS ( <b>AT*M6</b> )
Bit 6	Key abort	0: Key abort activated ( <b>AT%B0</b> ) 1: Key abort deactivated ( <b>AT%B1</b> )
Bit 7	Call acceptance	1: Call answer not locked ( <b>AT*A1</b> ) 0: Call acceptance locked ( <b>AT*A0</b> )

**S38** Time period until forced hang up

Maximum time left for the buffers to empty their data, after a command to hang up has been received. Only applies to error corrected connections.

**S39\*** Flow control

Selection of the data flow control between the PC and the modem

S39=0 No data flow control (**AT&K0**)

S39=3 RTS/ CTS data flow control (**AT&K3**)

S39=4 XON/ XOFF data flow control (**AT&K4**)

S39=5 Transparent XON data flow control (**AT&K5**)

S39=6 RTS/CTS and XON/XOFF data flow control

**S40\*** Break handling and MNP5 block size

Bit	Meaning	
Bit 0	Reserved	
Bit 1	Reserved	
Bit 2	Reserved	
Bit 3-5	Break handling	Break handling 0: see <b>AT\K0</b> 1: see <b>AT\K1</b> 2: see <b>AT\K2</b> 3: see <b>AT\K3</b> 4: see <b>AT\K4</b> 5: see <b>AT\K5</b>
Bit 6-7	MNP block size	MNP block size 0: 64 characters ( <b>AT\A0</b> ) 1: 128 characters ( <b>AT\A1</b> ) 2: 192 characters ( <b>AT\A2</b> ) 3: 256 characters ( <b>AT\A3</b> )

**S41\*** Compression settings: Compression type, retrain

Bit	Meaning	
Bit 0.1	Select compression type	Compression Selection 0: No compression ( <b>AT%C0</b> ) 1: MNP5 ( <b>AT%C1</b> ) 2: V42bis ( <b>AT%C2</b> ) 3: MNP5 or V.42bis ( <b>AT%C3</b> )
Bit 2	Auto retrain	Auto retrain control 0: No auto retrain ( <b>AT%E0</b> ) 1: Auto retrain ( <b>AT%E1</b> )
Bit 3	Reserved	
Bit 4	Reserved	
Bit 5	Reserved	
Bit 6	Fall back/fall forward	FB/FF control 0: No FB/FF 1: FB/FF ( <b>AT%E2</b> )
Bit 7	Reserved	

**S46\*** V.42bis Data Compression

S46=136 No data compression

S46=138 V.42bis data compression on

**S48\*** V.42bis Connection setup protocol

S48=0 Only LAPM connection possible

S48=7 LAPM or MNP 4 connection

S48=128 Connection protocol as laid down in S36

**S86** Error event code

When a connection fails (**NO CARRIER**), an event code is written into this registry.

S86=0	Normal disconnect, no error
S86=4	Carrier lost
S86=5	No establishing of an error-corrected (V.42) connection
S86=6	No extensions could be negotiated
S86=7	Remote terminal only supports synchronous modems
S86=8	No joint framing detected
S86=9	No protocol could be established
S86=10	Invalid answer when negotiating extensions
S86=11	No synchronous marks received from remote terminal
S86=12	Normal disconnection by remote terminal
S86=13	Remote terminal didn't respond any more (ten attempts)
S86=14	Protocol error
S86=15	DTR drop
S86=16	Remote terminal demanded clear-down (GSTN clear-down)
S86=17	Inactivity timer expired
S86=18	Desired speed is not supported
S86=19	Long space disconnect
S86=20	Key abort (character was sent during connection setup)
S86=22	No connection setup possible
S86=23	Clear-down after 3 retrains
S86=25	Termination of the connection by the remote terminal or by a phone connected in series
S86=26	Remote terminal hung up

**S91\*** Transmit Level

The value for the transmit level of the modem is stored in the S91 registry. The value can be set between 0 and 15. The connection can in some cases be improved by decreasing the transmit level.

S91=0	Transmit level 0 dBm
S91=15	Transmit level -15 dBm

**Note:** **The range and the default value depend on the country settings (AT+GCI).**

**S95\*** Result Code Control – Result code

Bit	Meaning
Bit 0	CONNECT message with line speed
Bit 1	CONNECT/ARO message for error corrected connection
Bit 2	CARRIER messages enabled (messages 40 – 47)
Bit 3	PROTOCOL messages enabled (messages 70 – 80)
Bit 4	Reserved
Bit 5	COMPRESSION message enabled (messages 66 - 69)
Bit 6	Reserved
Bit 7	Reserved

## 16 SMS Provider / Service Center

The following is an overview of network providers in Germany. All information is without guarantee and may change without notifying INSYS. All necessary information is available from the customer service center of the provider.

The dispatch time of an alarm message from sender to recipient depends on the respective service center provider. An alarm message may take some more time to be sent depending on capacity utilisation and time of day. Please note that there is no confirmation about a successful alarm SMS delivery.

### 16.1 Alarm via SMS

In case of an alarm dispatch via SMS, it is only possible to send SMS into the network of the service provider, whose service center has been configured. The service providers T-Home and Anny Way enable to send SMS to all German mobile phone networks at the moment.

Network provider	Country	Service center number	Phone number format	Example
T-Mobile (D1)	D	0171 2521002	Network code + phone number	0171 1234567
Vodafone (D2)	D	0172 2278000	Network code + phone number	0172 1234567
O2	D	0179 7673425	Network code + phone number	0179 1234567
Anny Way	D	0900 32669000	Network code + phone number	0170 1234567
T-Home (landline)	D	0193010	Network code + phone number	0941 1234567

Table 10: Provider for alarm dispatch via SMS

### 16.2 Alarm Using E-Mail via SMS

Different service providers also allow to send an alarm to an e-mail address. Mostly, the e-mail address precedes the message text separated by a blank in this case. With this, the alarm message, which contains the e-mail address and the message text, will be sent as SMS.

Network provider	Country	Service center number	Phone number	Message format
T-Home	D	0193010	8000	name*provider.de message text
Anny Way	D	0900 32669000	6245	name@provider.de:message text

**Table 11: Provider for alarm dispatch using e-mail via SMS**

## 17 Tables and Diagrams

### 17.1 List of Tables

Tabelle 1: Technological Features .....	15
Table 2: Description of the LEDs on the front .....	16
Table 3: Description of the pin layout of the D-sub socket .....	17
Table 4: Description of the pin layout of the RJ12 connector and the TAE connector .....	18
Table 5: Possible combinations of the individual functions of the priority circuit ...	43
Table 6: Line states and behavior of the priority circuit .....	44
Table 7: AT responses depending on the ATX command .....	78
Table 8: Country codes to adjust the local requirements .....	82
Table 9: Overview S Registry: Units, value range, presets .....	84
Table 10: Provider for alarm dispatch via SMS .....	94
Table 11: Provider for alarm dispatch using e-mail via SMS .....	95

### 17.2 List of Diagrams

Figure 1: LEDs on the front .....	16
Figure 2: Connections on the back .....	17
Figure 3: 9 pin D-sub socket at the device .....	17
Figure 4: RJ12 plug connected with TAE connector .....	18
Figure 5: Line states and voltages in the line .....	43



## 18 Index

Additional information.....	8	Moisture .....	12
Alternative results .....	8	Overcurrent .....	12
AT commands .....	25	Overvoltage .....	13
Breakdown .....	9	Overvoltage protection.....	13
Checkmark .....	8	Permissible limit.....	10
Command mode .....	26	Personnel .....	10
Command Mode .....	25	Phone line .....	25
Country code.....	79	Phone system.....	26
Data connection.....	25	Preface .....	6
Defects liability terms.....	6	Prerequisites.....	8
Dialing tone .....	26	Qualification .....	10
Electrical installation .....	12	Recycling.....	49
Environment.....	12	Remote configuration.....	25
Environmental Protection.....	11	Repair .....	12, 48
Escape sequence.....	25	Repurchasing .....	49
Explosive atmosphere .....	9	Responsibilities of the operator.....	10
Factory settings.....	79	Ring tone .....	25, 26
Fire hazard.....	12	Safety .....	9
Firmware .....	46	Short-cut .....	12, 48
Formatting.....	8	Standard.....	15
General safety instructions.....	12	Storage.....	10
Going off-hook .....	26	Surface .....	13
Guideline .....	15	Symbol .....	7, 8
Hardware dataflow control.....	25	Terminal program .....	25
Housing .....	13	Transport .....	10
Key word .....	7	Update.....	46
Liquids.....	12	Usage according to the regulations ..	9
Marking .....	7	Water spray.....	12
Modification .....	12, 48		

