

Substation hardened (S)NTP-Server with integrated GPS-Receiver 7SC802x

The substation hardened (S)NTP-Server 7SC802x offers together with the optional available GPS-antenna kit 7XV5663-0AA00 and the indirect lightning protection 7XV5664-0LA00 a comprehensive solution for time synchronization of any number of SIPROTEC protection devices via (S)NTP-Protocol. The GPS-antenna has to be mounted with a free view to the whole sky, on the top of a roof or an outside wall. The optional lightning protection will be within the antenna cable. The 7SC802x will be mounted close to GPS-antenna and can be connected to usual AC supply or station battery. The configuration will be done with DIGSI 4.

The transmission of the time telegrams takes place, even via large distances, immune to disturbances in an EMC stressed environment, with a FO cable to the station bus.

Features / Shipment 7SC802x:

- GPS-antenna interface (SMB-connector)
- USB-Port for configuration with DIGSI 4
- Default equipped with 2 electrical Ethernet ports RJ45
- Dual armed connection in Active-Standby configuration
- Equipped with 2 optical Ethernet interfaces (optional)
- Detached operation possible, with Single mode interfaces up to 24 km
- Complete support of redundant network structures with RSTP/PRP/ HSR Protocol
- Stainless steel housing
- Fulfills EMC requirements in substations
- Extended temperature range
-50 °C - +85 °C
- Remote Access
- Power supply
24/48 V DC, 60 – 250 V DC and 110 - 230 V AC
- 12 Binary inputs
8 and 4 inputs with common ground
- 8 Binary outputs
- 1 Life contact
Changeover



Features / Shipment antenna kit 7XV5663-0AA00:

- Hopf GPS outdoor antenna
- flat roof/wall mounting
- 25 m RG59-cable (BNC-connector)
- 1 m adapter cable BNC - SMB

Substation hardened (S)NTP-Server with integrated GPS-Receiver 7SC802x

Time Synchronization of SIPROTEC devices

Using the **(S)NTP-Server 7SC802x**, the device internal time of all via Ethernet connected (protection) devices can be synchronized. In this way, the internal clock of the protection devices is synchronized by standardized (S)NTP-Protocol telegrams.

The protective relays SIPROTEC 4/5 or compact have to have suitable Ethernet interfaces.

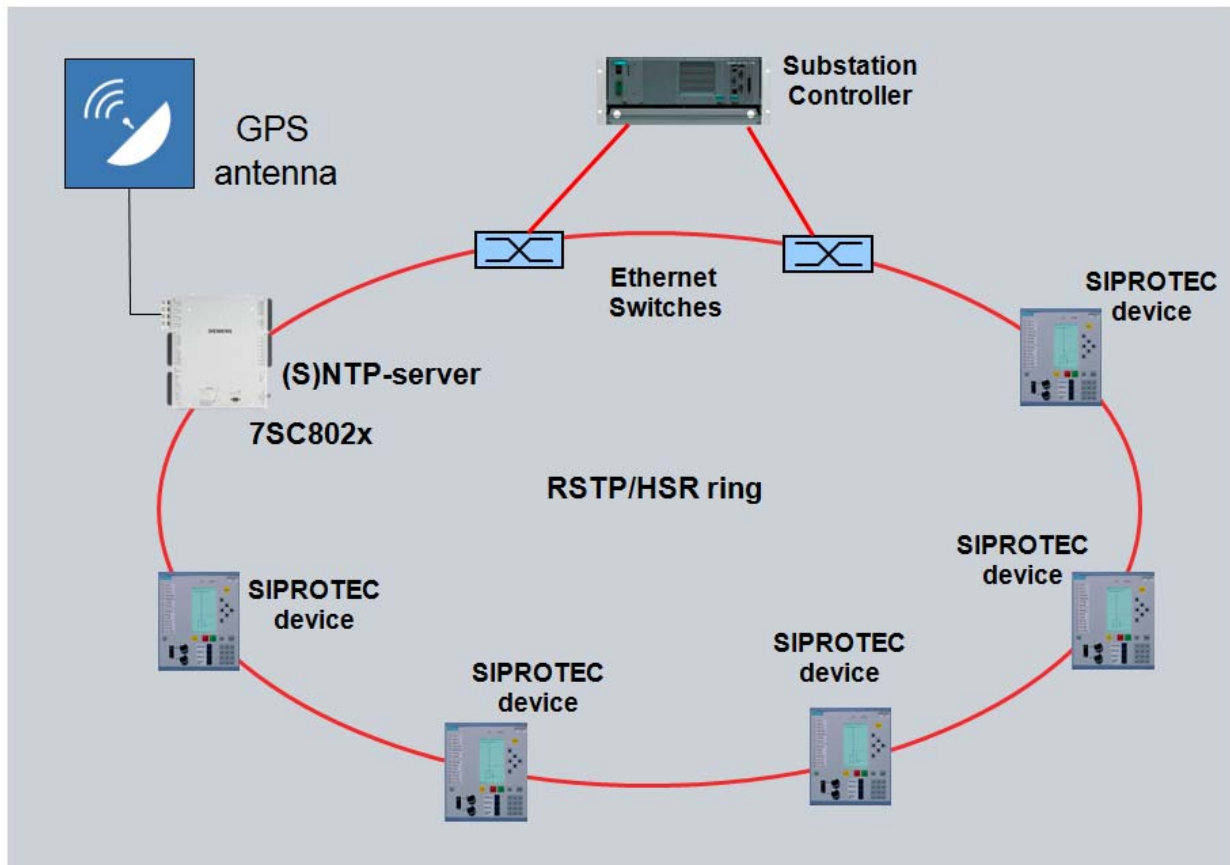

Example of a redundant integration of a 7SC802x (S)NTP-server in an optical Siprotec 4 ring network

Substation hardened (S)NTP-Server with integrated GPS-Receiver 7SC802x

General information

Basically for the (S)NTP-Server 7SC802x all available [manuals and documents](#) of 7SC80 basic device apply accordingly. All necessary information for intended use is contained there. These documents are available in Inter-/Intranet (Siprotec compact Sharepoint).

For a complete integration of the (S)NTP-server in the IEC61850 system configurator (no sntp.icd file, GOOSE messages) a DIGSI version 4.87 or newer is necessary. If not possible, with configuration of the (S)NTP-server in a separate DIGSI project, an older DIGSI version with IEC61850 system configurator can be used.

If 7SC802x is used as (S)NTP-server for 3rd-party devices only, follow the setting instructions in the 7SC802x parameter set, DIGSI Basic version is sufficient. All further settings in the 3rd party devices have to be done in their dedicated configuration tools.

All DIGSI relevant [documents](#) apply accordingly.

For handling and mounting of the separate orderable GPS antenna kits the technical descriptions, requirements and details by Hopf apply accordingly. The corresponding information is available in Siemens SharePoint, download area Protection - SIPROTEC - Accessories, Communication and Test Equipment – 7XV5664: [GPS general information](#)

Block diagram:

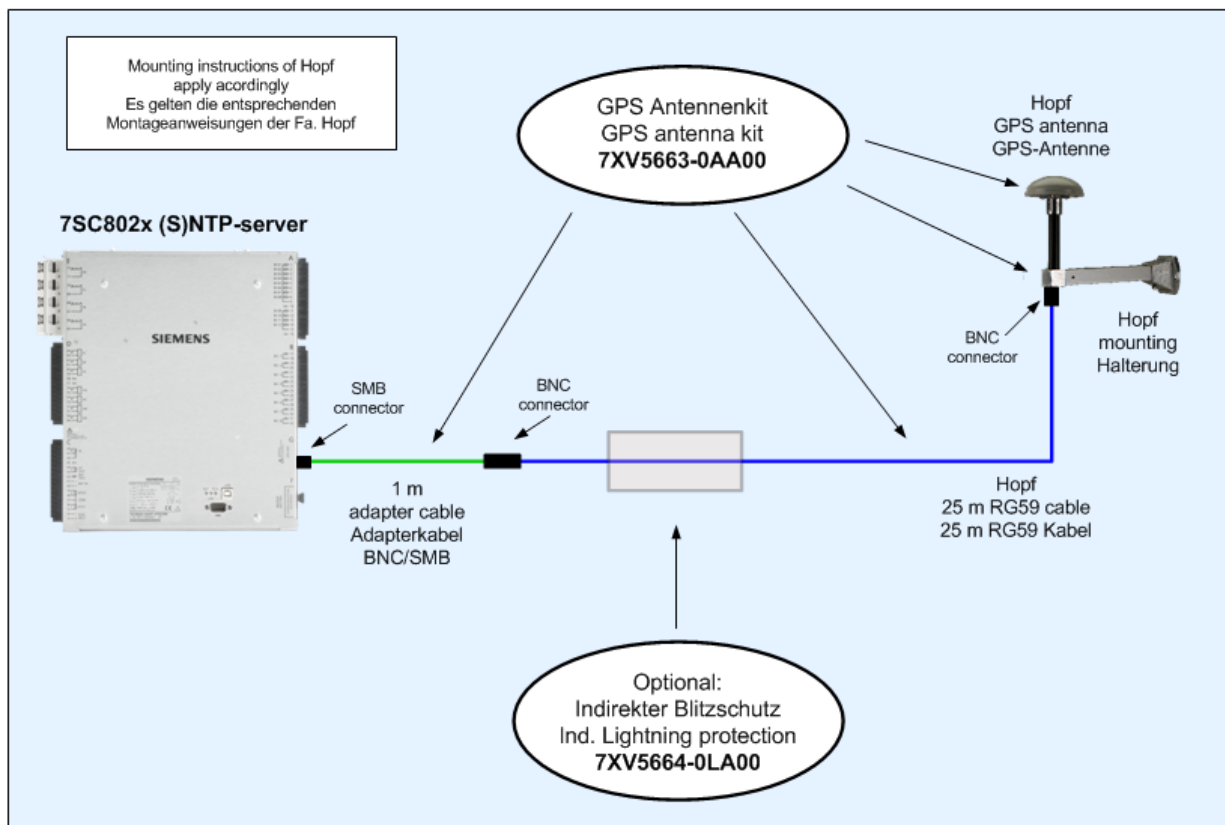

Substation hardened (S)NTP-Server with integrated GPS-Receiver 7SC802x

Configuration of 7SC802x:

Insert the parameter set of 7SC802x to the DIGSI project.

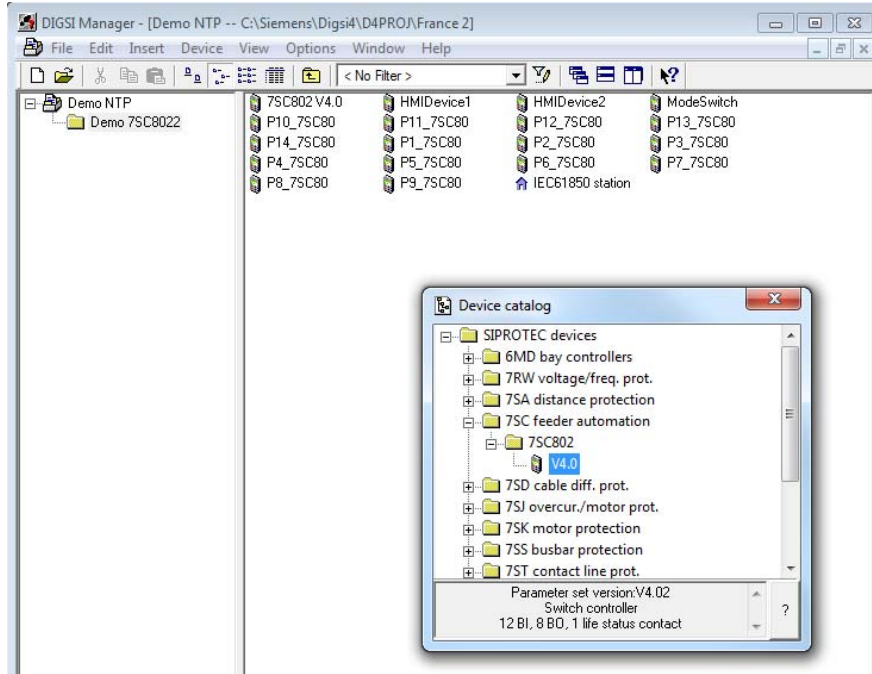

Configure the corresponding MLFB number for the (S)NTP-Server.

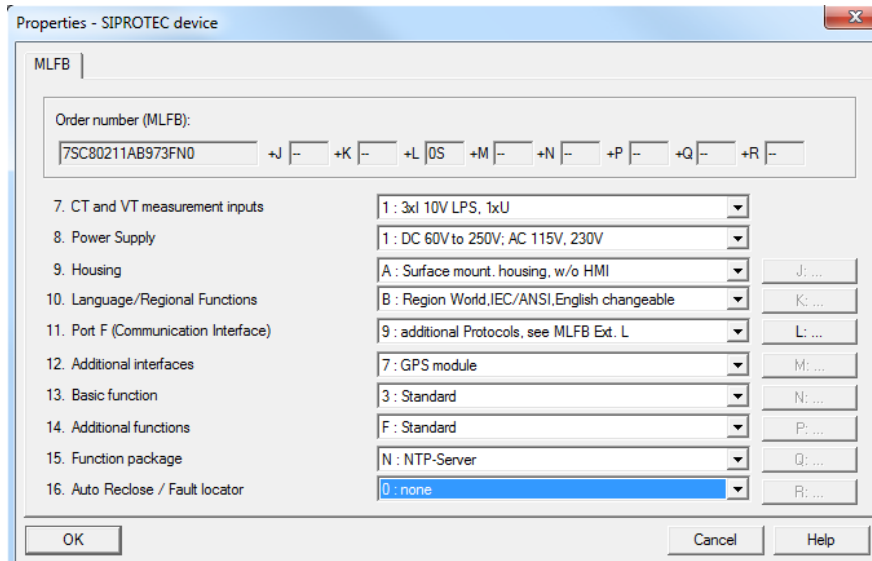

Substation hardened (S)NTP-Server with integrated GPS-Receiver 7SC802x

Open the properties menu and insert IED name and IP address information.

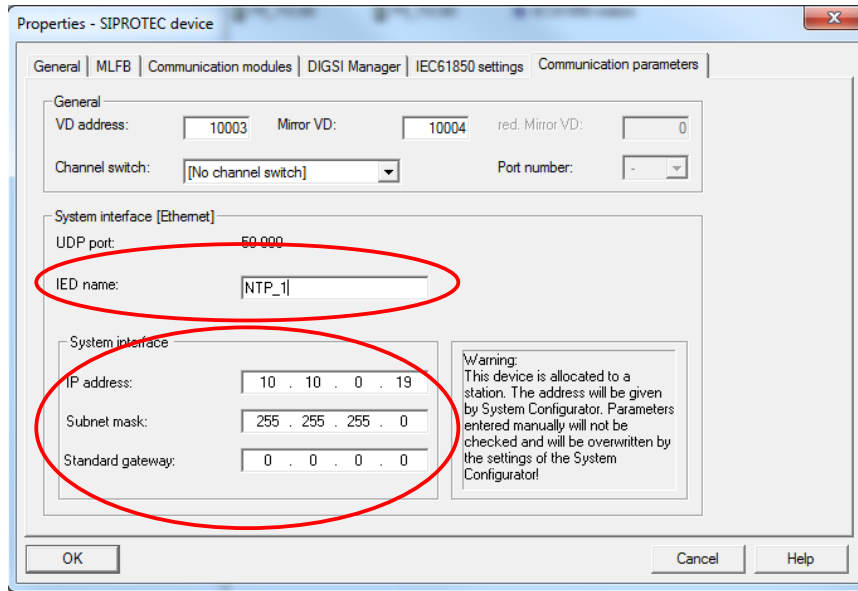

Open device parameter set, menu „time synchronization“ and choose “GPS” as source of time synchronization. The 7SC802x (S)NTP server will supply standardized UTC-time or time specified in “Time synchronization & Time Format” menu. Adaption to local time can be configured in the dedicated protection devices (SNTP-clients) as well.

Via web based HMI an offset to time signal can be entered as well directly:
Parameter→SETUP/EXTRAS→clock setup

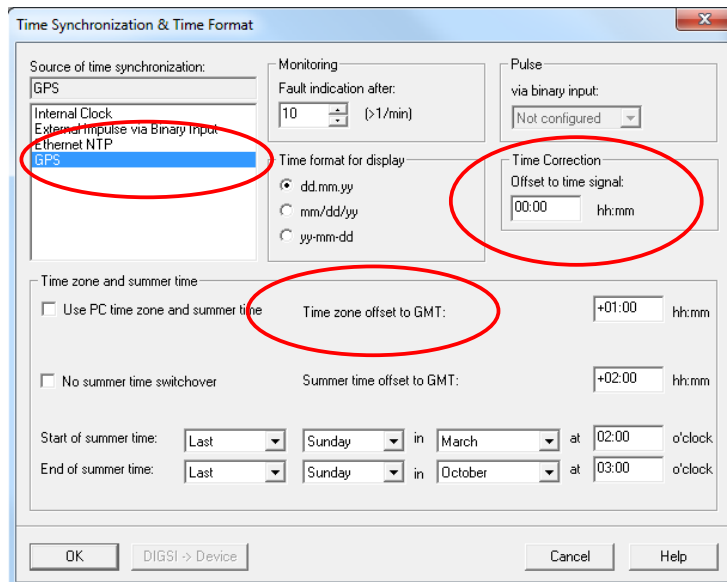

If necessary configure further project specific settings (matrix, indications, access rights,...) in parameter set, these are independent from (S)NTP-server features and can be set up like in all other DIGSI 4 configurations.

Substation hardened (S)NTP-Server with integrated GPS-Receiver 7SC802x

Open the properties menu of IEC61850 system configurator and add the (S)NTP-Server to the station.

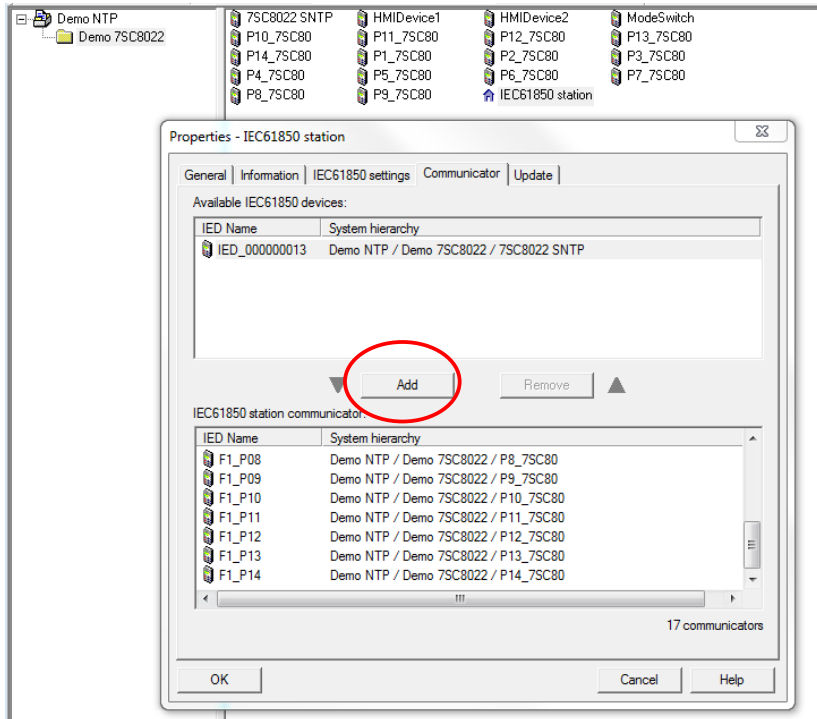

Open the IEC61850 system configurator and check/change the relevant settings for the (S)NTP-Server.

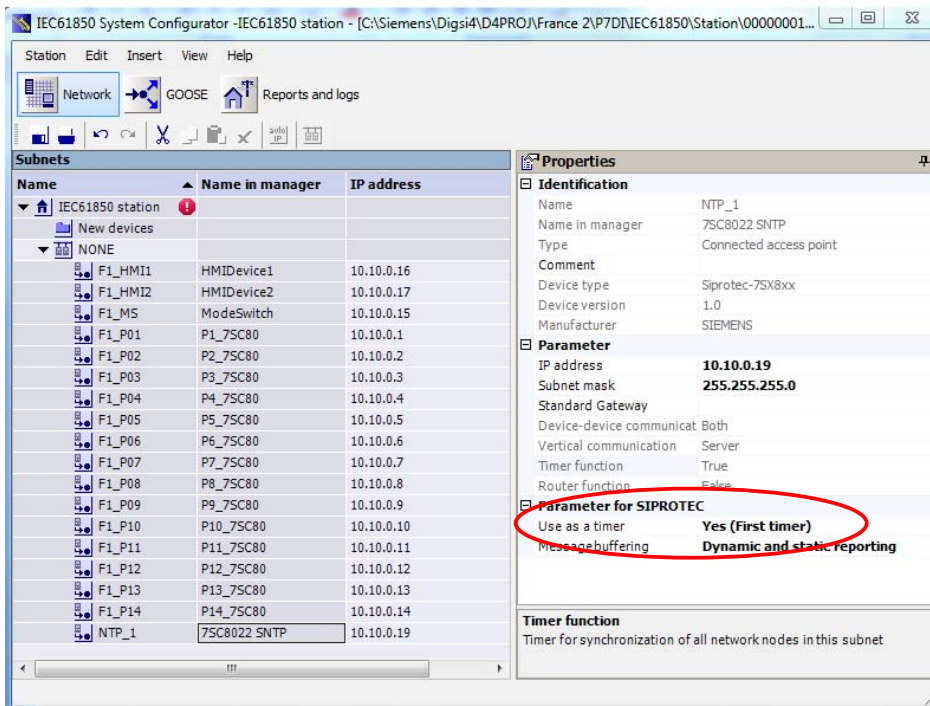

Substation hardened (S)NTP-Server with integrated GPS-Receiver 7SC802x

When using a redundant (S)NTP-Server, add the second one like described above to the DIGSI project, in the IEC61850 system configurator you can set which of both will work as first and which of both will work as secondary (S)NTP-Server.

To set the (S)NTP-Server(s) in service follow the typical workflow of IEC61850 projects.

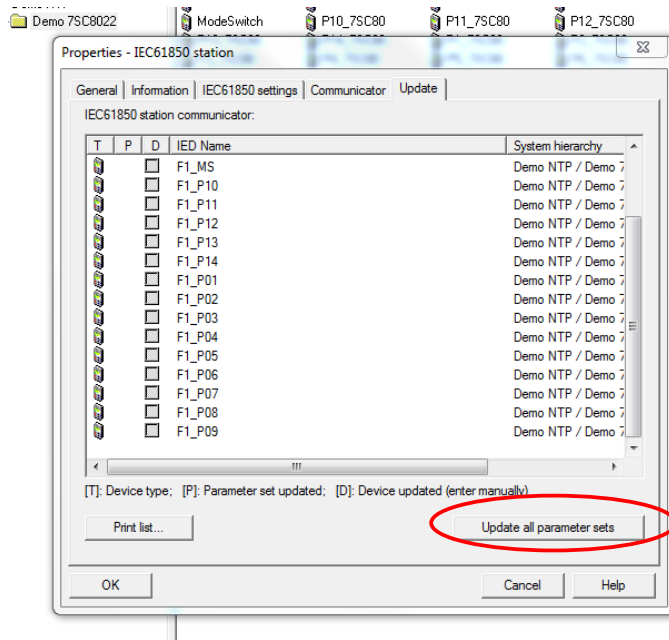

Finally initialize/update the devices.

Substation hardened (S)NTP-Server with integrated GPS-Receiver 7SC802x

In 7SC802x (S)NTP-Server you have online access to several information:

<IP-Address>/gps displays the amount of discovered satellites, module time and date and GPS coordinates.

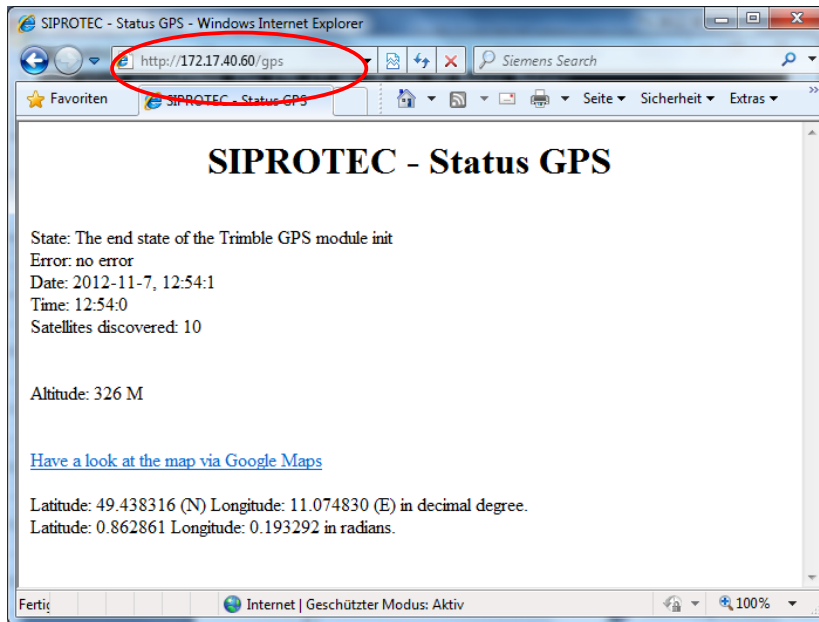

<IP-Address>/sntp displays a table of all connected (S)NTP-Clients

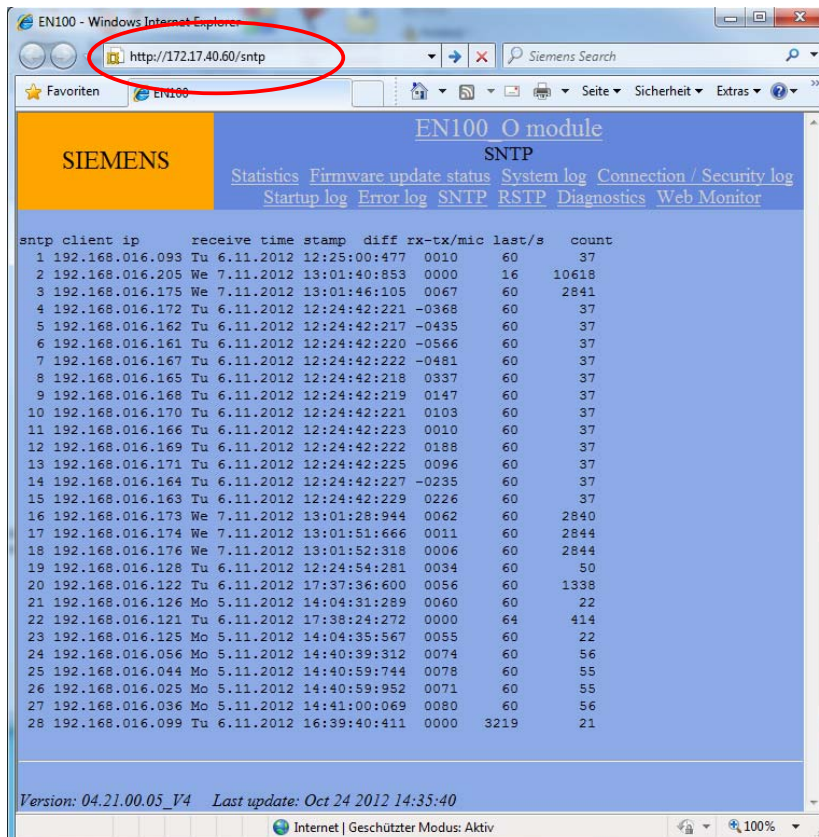

Substation hardened (S)NTP-Server with integrated GPS-Receiver 7SC802x

Syslog-page <IP-Adresse>/printf records loss of synchronization (insufficient satellites).

```

EN100 - Windows Internet Explorer
http://172.17.40.60/printf
Siemens Search
Favoriten EN100 SIPROTEC - Status GPS
+++ 00036 00131340 Su 2.01.1994 04:18:18:342 IEC8: IEC61850: Listening on Nr C1000 port
+++ 00037 00131559 Su 2.01.1994 04:18:18:355 Starting in Edition 1 modus
+++ 00038 00131563 Su 2.01.1994 04:18:18:358 IEC8: Starting dynamic creation of object directory
+++ 00039 00132696 Su 2.01.1994 04:18:19:493 IEC8: LNTyp: 1 - New local runtime type successfully created (LN: MMXU)
+++ 00040 00133373 Su 2.01.1994 04:18:20:170 IEC8: LNTyp: 2 - New local runtime type successfully created (LN: MMTR)
+++ 00041 00133655 Su 2.01.1994 04:18:20:452 IEC8: LNTyp: 3 - New local runtime type successfully created (LN: MSQD)
+++ 00042 00133796 Su 2.01.1994 04:18:20:592 IEC8: LNTyp: 4 - New local runtime type successfully created (LN: LPHD)
+++ 00043 00133859 Su 2.01.1994 04:18:20:656 IEC8: LNTyp: 6 - New local runtime type successfully created (LN: CALH)
+++ 00044 00133921 Su 2.01.1994 04:18:20:717 IEC8: LNTyp: 7 - New local runtime type successfully created (LN: LPHD)
+++ 00045 00134010 Su 2.01.1994 04:18:20:807 IEC8: LNTyp: 8 - New local runtime type successfully created (LN: XCBR)
+++ 00046 00134143 Su 2.01.1994 04:18:20:940 IEC8: LNTyp: 9 - New local runtime type successfully created (LN: CSWD)
+++ 00047 00134209 Su 2.01.1994 04:18:21:005 IEC8: LNTyp: 10 - New local runtime type successfully created (LN: CILO)
+++ 00048 00134300 Su 2.01.1994 04:18:21:096 IEC8: LNTyp: 11 - New local runtime type successfully created (LN: XSWI)
+++ 00049 00134389 Su 2.01.1994 04:18:21:185 IEC8: LNTyp: 12 - New local runtime type successfully created (LN: LLNO)
+++ 00050 00134539 Su 2.01.1994 04:18:21:336 IEC8: LNTyp: 13 - New local runtime type successfully created (LN: LLNO)
+++ 00051 00134615 Su 2.01.1994 04:18:21:411 Device GPSMEAS successfully added
+++ 00052 00134616 Su 2.01.1994 04:18:21:413 Device GPSCTRL successfully added
+++ 00053 00135552 Su 2.01.1994 04:18:22:349
+++ 00054 00135552 Su 2.01.1994 04:18:22:349 The following connections have been established:
+++ 00055 00135553 Su 2.01.1994 04:18:22:349
+++ 00056 00135708 Su 2.01.1994 04:18:22:504 HGP active
+++ 00057 00135708 Su 2.01.1994 04:18:22:504 MAP: GI device - module started
+++ 00058 00135755 Su 2.01.1994 04:18:22:551 MAP: GI device - module completed
+++ 00059 462849034 Mo 29.10.2012 21:53:01:100 GPS sync loss
+++ 00060 4629.0013 Mo 29.10.2012 21:54:01:280 GPS sync OK (1min)
+++ 00061 1212057166 We 7.11.2012 14:00:01:284 GPS sync loss
+++ 00062 1212117144 We 7.11.2012 14:01:01:263 GPS sync OK (1min)
end of system log
Internet | Geschützter Modus: Aktiv
  
```

Several indications are available in matrix which can be displayed at (web based) HMI or can be send to SCADA/control center via IEC61850 reporting:

eg. GPS module error. GPS time ok, GPS antenna ok

00068	Clock SyncError		OUT
00069	DayLightSavTime		OUT
02172	GPS ModuleError		OUT
06009	GPS time ok		OUT
06010	GPS antenna ok		OUT

(S)NTP-server service is only active if a GPS antenna is connected to 7SC802x.

If Receiver is not synchronized with GPS-satellites, 7SC802x is reacting on (S)NTP requests with its internal time and STRATUM is set to 15. If receiver is synchronized, STRATUM is set to 1.

(S)NTP service is started automatically after GPS time receiver is synchronized with satellites, at least 3 satellites are necessary to synchronize the GPS receiver of the (S)NTP server.

Substation hardened (S)NTP-Server with integrated GPS-Receiver 7SC802x

With new firmware version 4.05 for 7SC802x a dedicated default time display is available.

The following information is displayed:

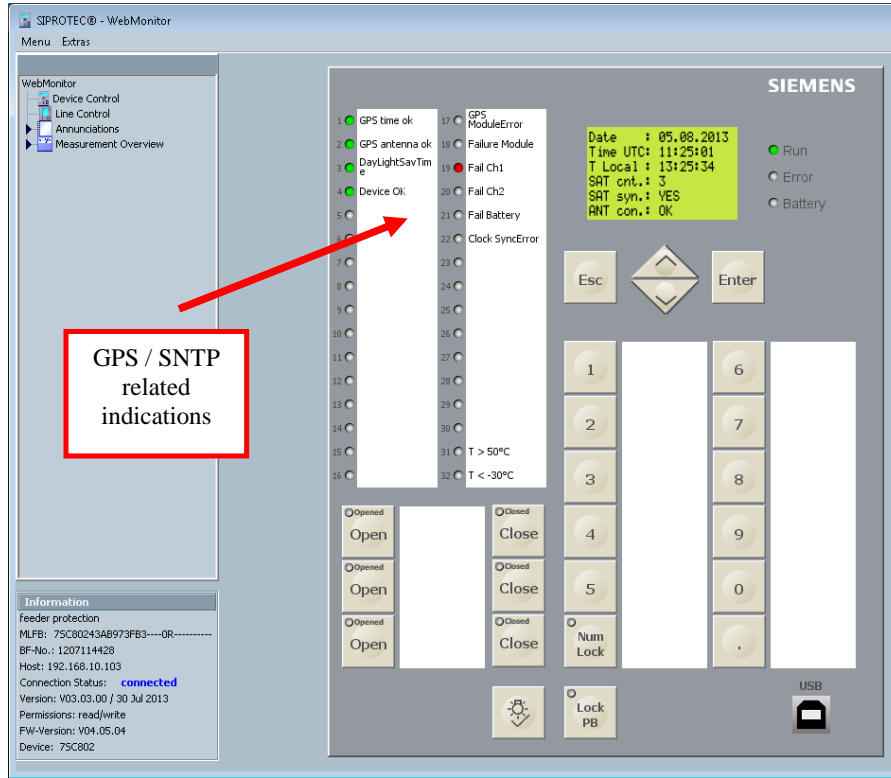

Received UTC-date via GPS

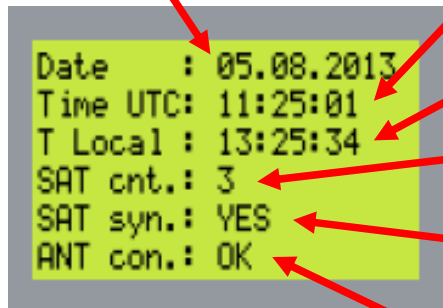

Received UTC-time via GPS (will be refreshed once a minute)

Local (S)NTP time (will be refreshed once a second)

Amount of visible satellites

GPS-Receiver synchronized information: (YES/NO)

Antenna connection information (Detection lasts up to one minute)

OK antenna connected

No connect. antenna disconnected

n.a. status not yet available, e.g. during start up of module

shortend short circuit of antenna port