

SIEMENS

SICAM I/O Unit

7XV5673

Product Information



E50417-B1050-C484-A3



Note

Please observe the Notes and Warnings for your own safety in this Product Information. This Product Information contains important information about the SICAM I/O Unit 7XV5673 and is part of the product delivery.

Statement of Conformity

CE	<p>This product complies with the directive of the Council of the European Communities on the approximation of the laws of the Member States relating to electromagnetic compatibility (EMC Council Directive 2004/108/EC) and concerning electrical equipment for use within specified voltage limits (Low-voltage Directive 2006/95/EC).</p> <p>This conformity has been established by means of tests conducted by Siemens AG in accordance of the Council Directive in agreement with the generic standards EN 61000-6-2 and EN 61000-6-4 for the EMC directives, and with the standard EN 60255-27 for the low-voltage directive.</p> <p>The device has been designed and produced for industrial use.</p>
-----------	---

Further

IEEE Std C 37.90

This product is UL-certified to Standard UL 508, based on the specification stated in Chapter 15 (Technical Data).

UL File No.: E194016



IND. CONT. EQ.
69CA

Document Release: E50417-B1050-C484-A3.00

Edition: 05.2012

Product version: V2.00

Contents

1	Preface	4
2	General Information	5
3	Information for Your Safety	6
4	Used Symbols	9
5	Ordering Information	10
6	Application	11
7	Design	13
8	Assembly and Commissioning	15
9	Application Examples	21
10	Interfaces	25
11	Replacing the Battery	29
12	LED Indications	31
13	Troubleshooting and Repair	35
14	Storage and Transport	36
15	Technical Data (Selection)	37

1 Preface

Disclaimer of liability

This document has been subjected to rigorous technical review before being published. It is revised at regular intervals, and any modifications and amendments are included in the subsequent issues. The content of this document has been compiled for information purposes only. Although Siemens AG has made best efforts to keep the document as precise and up-to-date as possible, Siemens AG shall not assume any liability for defects and damage which result through use of the information contained herein.

This content does not form part of a contract or of business relations; nor does it change these. All obligations of Siemens AG are stated in the relevant contractual agreements.

Siemens AG reserves the right to revise this document from time to time.

Copyright

Copyright © Siemens AG 2012. All rights reserved.

The disclosure, duplication, distribution and editing of this document, or utilization and communication of the content are not permitted, unless authorized in writing. All rights, including rights created by patent grant or registration of a utility model or a design, are reserved.

Registered Trademarks

SIPROTEC®, SENTRON®, and SICAM® are registered trademarks of Siemens AG. An unauthorized use is illegal.

All other designations in this document can be trademarks whose use by third parties for their own purposes can infringe the rights of the owner.



NOTE

For further information, see the Device Manual SICAM I/O Unit 7XV5673, order number E50417-H1040-C484.

2 General Information

These Product Information contain the information required for the proper use of the devices described here. They are intended for personnel suitably qualified in electrical engineering with special training or relevant expertise in the area of automation engineering.

To ensure the safe installation, commissioning, operation and maintenance of the devices described in this document, personnel must be familiar with and practice the safety instructions and warnings in this document correctly. Only electrically qualified personnel (see “Personnel qualified in electrical engineering”) have the special knowledge required to interpret the general safety notes and warnings in this document correctly and apply them to suit the job at hand.

These Product Information are an integral part of the product. However, they cannot cover all details of all versions of the devices described here, nor can they

provide for all possible conditions concerning installation, operation, or maintenance.

If you need any further information, or if you are facing special problems that this document does not deal with in sufficient detail, please feel free to order the manual mentioned in Chapter 1.

If you have any questions about the device, please contact our Siemens sales partner responsible in your region.

Our Energy Customer Support Center is available to you twenty-four hours a day.

Phone: +49 (1805) 24-7000

Fax: +49 (1805) 24-2471

Internet: www.siprotec.com

e-mail: support.ic@siemens.com

3 Information for Your Safety

These Product Information do not list all the safety measures required to operate the equipment (module, device), since specific operating conditions may make additional measures necessary. However, they contain important information that you must observe in order to ensure your personal safety and to avoid material dam-

age. Such information is highlighted by a warning triangle and indicated as follows depending on the degree of danger:



DANGER

Danger means that death or severe injury **will** occur if the appropriate safety measures are not taken.

- Follow all advice instructions to prevent death or severe injury.



WARNING

Warning means that death or severe injury **can** occur if the appropriate safety measures are not taken.

- Follow all advice instructions to prevent death or severe injury.



CAUTION

Caution means that minor or moderate injury can occur if the appropriate safety measures are not taken.

- Follow all advice instructions to prevent minor injury.

NOTICE

Notice means that damage to property can occur if the appropriate safety measures are not taken.

- Follow all advice instructions to prevent damage to property.



NOTE

is important information about the product, the handling of the product, or the part of the documentation in question to which special attention must be paid.

Personnel qualified in electrical engineering

Commissioning and operation of the equipment (module, device) described in this Product Information must be performed by personnel qualified in electrical engineering only. As used in the safety notes contained in this Product Information, electrically qualified personnel are those persons who are authorized to commission, release, ground and tag devices, systems, and electrical circuits in accordance with safety standards.

Use as prescribed

The equipment (device, module) must not be used for any other purposes than those described in the catalog and the Technical Description. If it is used together with third-party devices and components, these must be recommended or approved by Siemens.

If the device is not used in accordance with this product information, the scheduled protection is impaired.

Correct and safe operation of the product requires adequate transportation, storage, installation, and assembly as well as appropriate use and maintenance.







During the operation of electric equipment, it is unavoidable that certain parts of this equipment will carry hazardous voltages. Severe injury or material damage can occur if the appropriate measures are not taken:

- Before making any connections at all, ground the equipment at the grounding terminal.
- Hazardous voltages can be present on all switching components connected to the power supply.
- Even after the supply voltage has been disconnected, hazardous voltages can still be present in the equipment (capacitor storage).

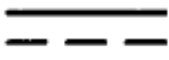
- The limiting values indicated in the product information must not be exceeded; this also refers to testing and commissioning.

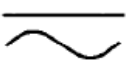
4 Used Symbols

Table 4-1 Used Symbols

No.	Symbol	Description
1		Direct current IEC 60417-5031
2		Alternating current IEC 60417-5032
3		Direct current and alternating current IEC 60417-5033
4		Protective conductor terminal IEC 60417-5019
5		Caution, risk of electric shock
6		Caution, risk of danger ISO 7000-0434

5 Ordering Information

Ordering code for a device:

Description	Order No. /MLFB																																
SICAM I/O Unit																																	
	<table border="1" style="margin-left: auto; margin-right: auto;"> <tr> <td>1</td><td>2</td><td>3</td><td>4</td><td>5</td><td>6</td><td>7</td><td>8</td><td>9</td><td>10</td><td>11</td><td>12</td><td>13</td><td>14</td><td>15</td><td>16</td> </tr> <tr> <td>7</td><td>X</td><td>V</td><td>5</td><td>6</td><td>7</td><td>3</td><td>-</td><td>0</td><td>J</td><td>J</td><td>0</td><td>-</td><td>A</td><td>A</td><td>1</td> </tr> </table>	1	2	3	4	5	6	7	8	9	10	11	12	13	14	15	16	7	X	V	5	6	7	3	-	0	J	J	0	-	A	A	1
1	2	3	4	5	6	7	8	9	10	11	12	13	14	15	16																		
7	X	V	5	6	7	3	-	0	J	J	0	-	A	A	1																		
SICAM I/O Unit , integrated electrical Ethernet interface, connection RJ45																																	
Device type																																	
Case 96 mm x 96 mm x 100 mm																																	
Inputs and outputs																																	
3 Binary inputs with adjustable threshold voltage, 3 Relay outputs (2 NO, 1 CO)																																	
3 Binary inputs with adjustable threshold voltage, 3 Relay outputs (2 NO, 1 CO)																																	
Serial interface and communication protocol																																	
Without serial communication	0																																
RS485 – Modbus RTU, I/O mirror	1																																
FO 820 nm – Modbus RTU, I/O mirror	2																																
Protection class																																	
Snap-on mounting unit, protection class IP20																																	
Communication interface and communication protocol																																	
Ethernet interface with Modbus TCP/UDP or I/O mirror	1																																
Ethernet interface with Modbus TCP/UDP, I/O mirror, or IEC 61850 (GOOSE, MMS, Reporting)	2																																
Features																																	
Integrated Ethernet switch																																	

Optional accessories are listed in the Device Manual SICAM I/O Unit 7XV5673, order number E50417-H1040-C484.

6 Application

SICAM I/O Unit 7XV5673 is a digital input/output device and is used by utilities (energy supply companies) in substation environment. The device is also used for industrial sectors and in businesses with increased environmental requirements. It can be used in nearly every application for protection relays or SCADA, e.g. over current protection, teleprotection or Substation Automation. Nearby and remote connection of binary I/O Inputs are possible using this SICAM I/O Unit. The device is applied, for example:

- For the bidirectional transmission of power protection and control signals via serial connections (RS485/ Fiber Optical) or Ethernet
- The acquisition and output of binary signals from the connected substation control system or protection devices using Modbus TCP/UDP, Modbus RTU, or IEC 61850 (GOOSE, MMS, Reporting)
- Contact multiplication of binary input signals

Inputs and outputs of the SICAM I/O Unit

The SICAM I/O Unit includes 2 terminal blocks, each provided with 3 binary inputs and 3 relay outputs. It also has an Ethernet port with an integrated Ethernet switch and a serial interface in the form of an RS485 interface or an optical interface (820 nm).

2 binary inputs are connected to common potential, one binary input is not connected to common potential (isolated). The threshold voltage of the binary inputs can be set to DC 19 V, DC 88 V, or DC 176 V. This enables optimum adjustment to the voltage of the substation battery.

The digital outputs are relay outputs. 2 relay outputs are designed as an NO (normally open) and one relay out-

put is designed as a CO (change-over) contact.

Function of the SICAM I/O Unit

Via binary inputs, all kinds of binary signals of switch gear/protection scheme (for example tripping command, switch position signal, fault and status indications) are securely detected. This information can directly be distributed at this SICAM I/O Unit over relays, or be transmitted over communication ways to further equipment or systems.

The information is transmitted protected about the Ethernet and the serial interface in telegrams.

The relays are operated using the relay outputs. The indication parameters are set up to 250 V for direct or alternating voltages and 5 A for direct and alternating current.

Communication of the SICAM I/O Unit

Communication with the control system and other peripheral units is performed using the Ethernet interface. Depending on the device type, the RS485 or optical interface is used. With the help of the integrated Ethernet switches and a Y-cable, further network components can be cascaded and integrated in an existing network with IEC 61850.

Parameter setting of the SICAM I/O Unit

The parameter setting is simply carried out with a standard Web browser at the PC which is connected by the Ethernet interface. A separate software is not required. When delivered, the IP address is: 192.168.0.55.

7 Design

The electrical modules of the device are installed in an insulated housing with the dimensions 96 mm x 96 mm x 100 mm (W x H x D). The housing is prepared for assembly on a DIN rail.

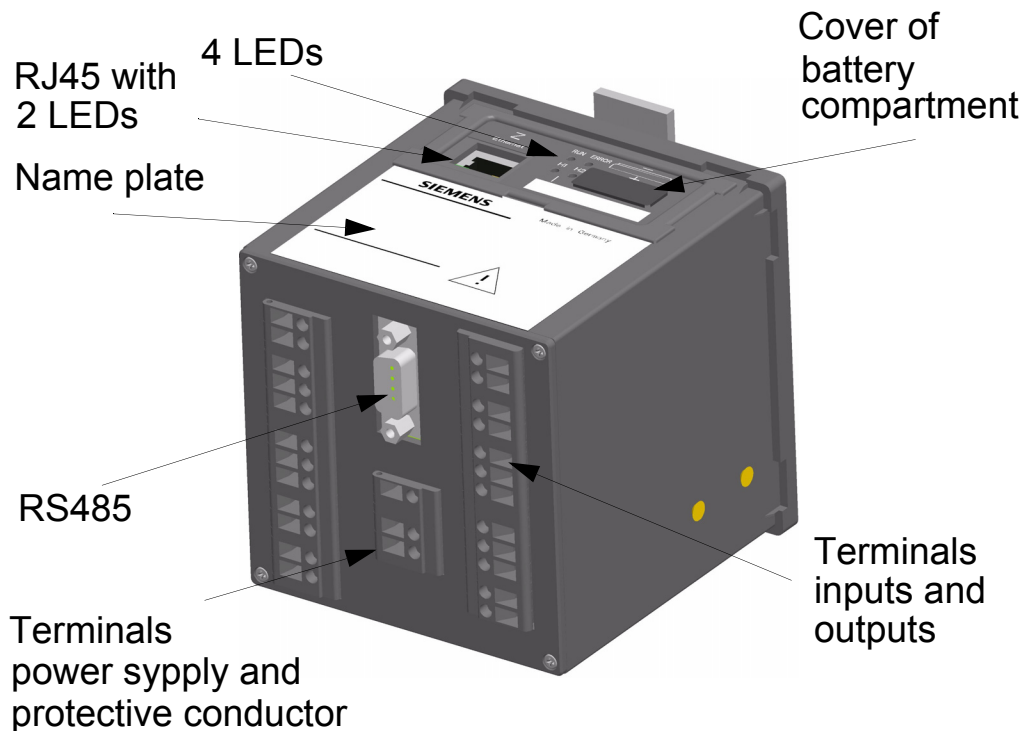

Figure 7-1 Terminal Side of SICAM I/O Unit 7XV5673

The top side of the device accommodates the RJ45 Ethernet connector with 2 LEDs and 4 additional LEDs. At the cover of the battery compartment, there is a labeling strip for the configurable LEDs H1/H2/ERROR and a battery symbol that indicates the polarity. The name plate is also located on the top side and provides among other information, the most important rated data of the device. The lithium battery is located under the removable cover of the battery compartment.

The connections for all inputs and outputs, for the supply voltage and the protective grounding are located on the terminal side of the device. The number, type, and

layout of the connections is described in Chapter 10.

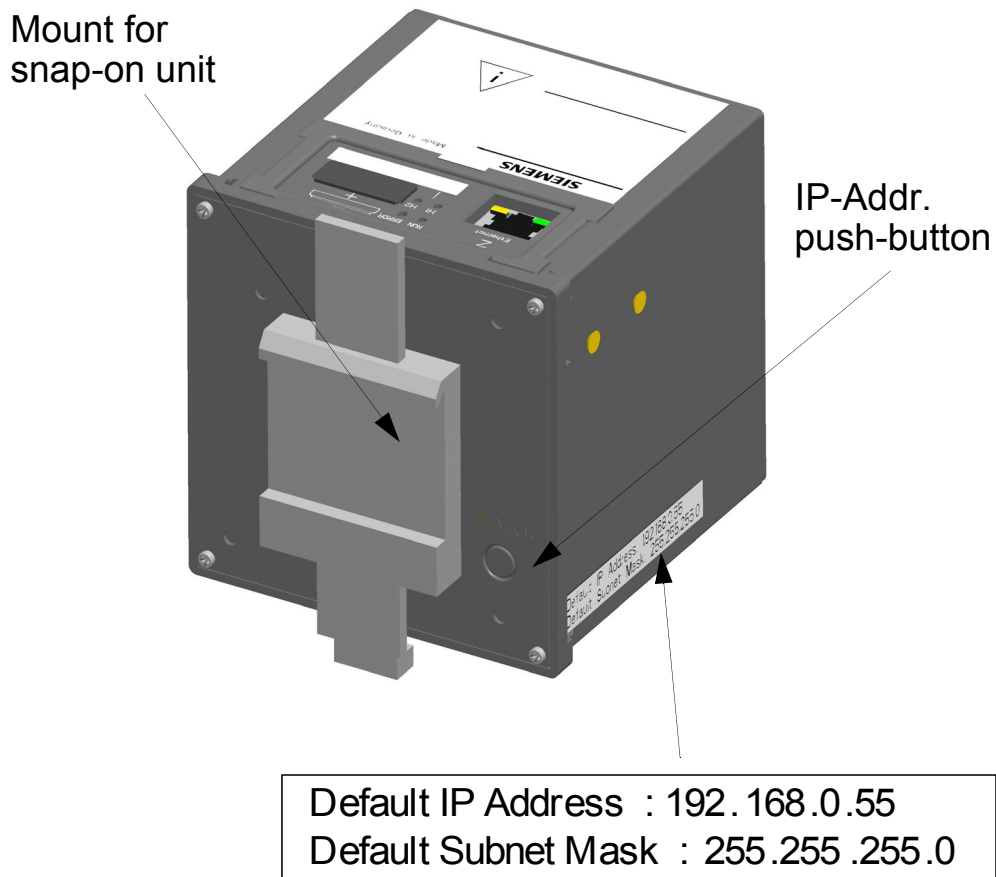

Figure 7-2 DIN Rail Side of the SICAM I/O Unit 7XV5673

The snap-in unit is mounted in the center of the DIN rail side. The IP-Addr. push-button is located in the lower right part. If necessary, it can be pressed (> 3 s) to adjust the factory-set default IP address. The IP address and the standard subnet mask are imprinted on the DIN rail side (see Figure 7-2).

8 Assembly and Commissioning

8.1 General Information



DANGER

Danger due to high voltages

Non-observance will lead to death or serious injury.

- Please read and observe all instructions and warnings contained in this document.
-
- The installation site should be vibration-proof. The permitted ambient temperature must be observed (see the technical data in Chapter 15).
 - Operating the device outside the permitted operating temperature range can lead to device failure.
 - The terminals are designed for conductor cross-sections of 2.5 mm² max. (AWG 14).
 - The device must not be exposed to condensation during operation.
 - The device should be installed in a location where it is not exposed to direct sunlight and strong temperature variations.

8.2 Assembly

Mount the device to a DIN rail according to EN 60750 in the following way:

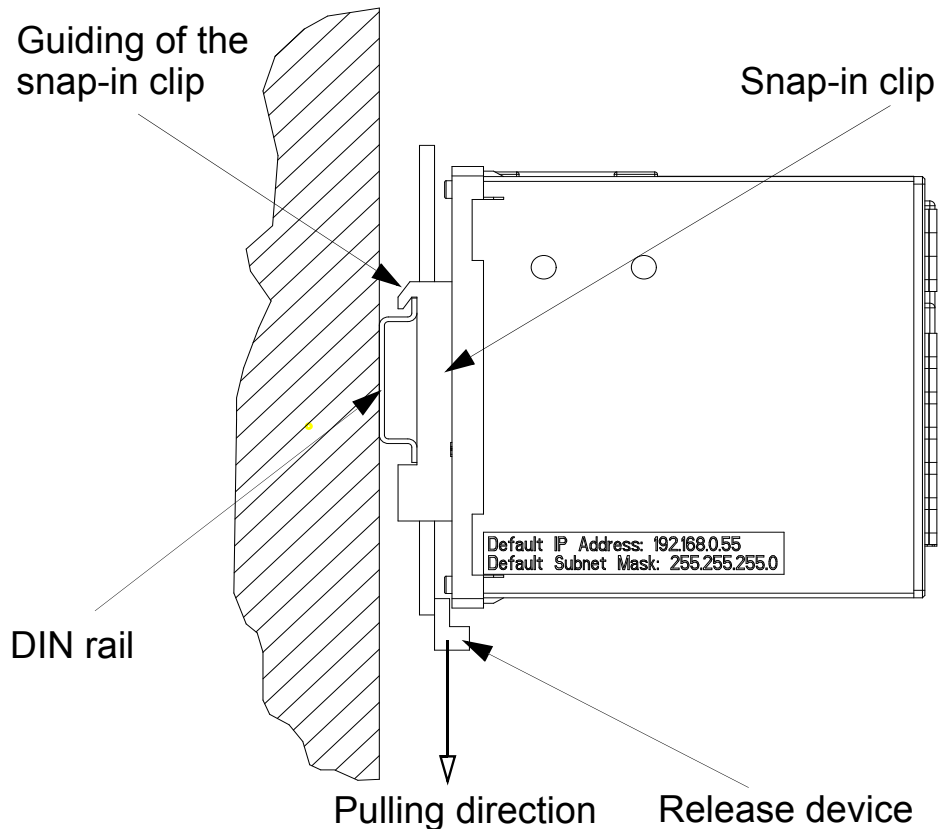

Figure 8-1 Assembly on a DIN Rail

1. Pull down the release device at the snap-in clip and hold it in this position.
2. Slide the device with the guiding of the clip-on to one side of the DIN rail.
3. Move the device into the desired position on the DIN rail.
4. Release the release device. The device is now firmly mounted on the DIN rail.



NOTE

The clip is adjusted to a certain height position by the manufacturer. You can change this position if necessary. To do so, lever the release device out of its guiding (no special tool required) and move the release device into the desired position. Subsequently, press the release device back into its guiding.

UL-certification conditions

Field Wires of Control Circuits shall be separated from other circuits with respect to the end use requirements!

8.3 Electrical Connection



DANGER

Danger due to high voltages

Non-observance will lead to death or serious injury.

- Work may only be carried out by trained personnel (see Preface) who are familiar with and observe the safety requirements and precautions.
 - Work may never be carried out if there is any dangerous voltage present.
 - De-energize the device.
 - In addition, a suitable isolating device shall be connected upstream in order to be able to disconnect the device from the power supply!
 - Secure the supply voltage with an approved (UL/IEC) fuse: 1.6 A, type C.
 - If a melting fuse is used, a suitable approved (UL/IEC) fuse holder has to be used.
-



NOTE

When performing electrical installations, you have to observe the national and international regulations on the construction of electric power installations.

-
- Before commissioning the device, check that all connections are made properly.
 - Connect the protective grounding terminal H  to the protective conductor of the switch panel or of the control cabinet.
 - Before commissioning the device, leave it in the final operating room for at least 2 hours. This allows it to reach room temperature and to prevent dampness and condensation.

8.4 Commissioning

Before you switch on the supply voltage, verify that the operational data match the rated data on the name plate and the technical data as in Chapter 15. This refers to the supply voltage U_H and the maximum power consumption P_H of the device.

After an operating time of approximately 15 min, the device will stay within the tolerances specified in the technical data.

The delivery includes a battery that powers the battery-buffered memory and the real-time clock.

Installation of the Battery

Upon delivery, the battery is insulated in the battery compartment of the device.

1. Lever the cover of the battery compartment out of the socket with a suitable tool (e.g. precision engineer screwdriver 2.0 mm).

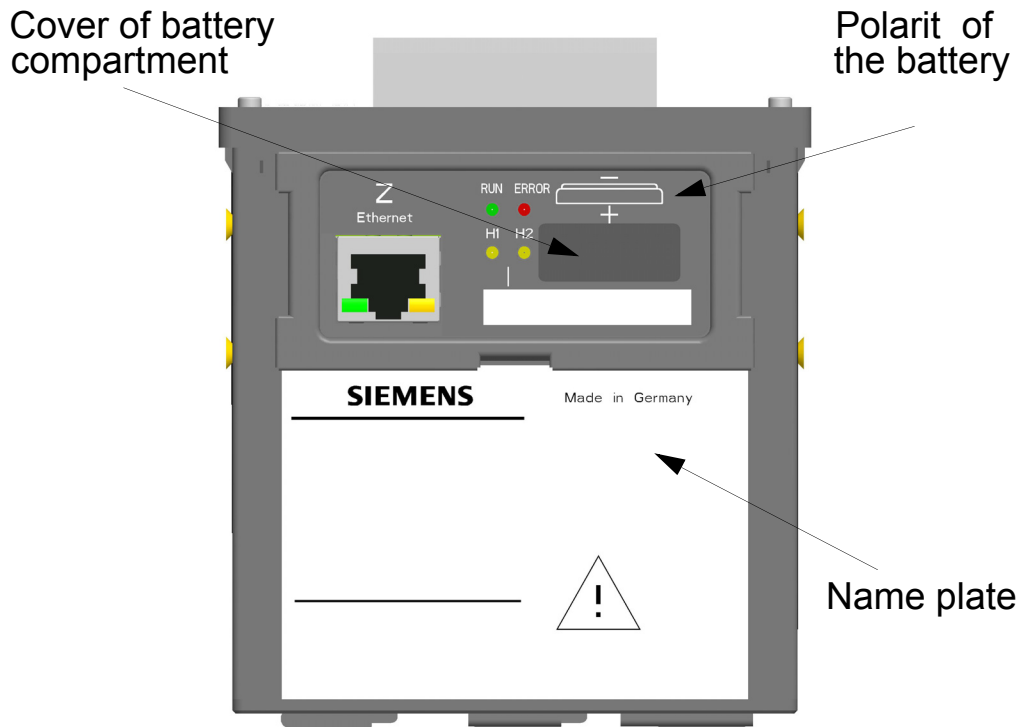

Figure 8-2 Device of Top Side

2. Remove the battery.
3. Remove the insulation from the battery.
4. Insert the battery with the polarity indicated on the cover of the battery compartment.
5. Close the cover.



NOTE

Chapter 11 describes how to replace and handle the battery.

Connecting further network components

With the integrated Ethernet switch and a Y-cable, further network components can be cascaded and integrated in an existing network.

8.5 Setting the Parameters



NOTE

The parameterization is described in the Device Manual SICAM I/O Unit 7XV5673, order number E50417-H1040-C484.

9 Application Examples



NOTE

A detailed description of the following application examples is included in the Device Manual SICAM I/O Unit 7XV5673, order number E50417-H1040-C484.

9.1 I/O Mirror

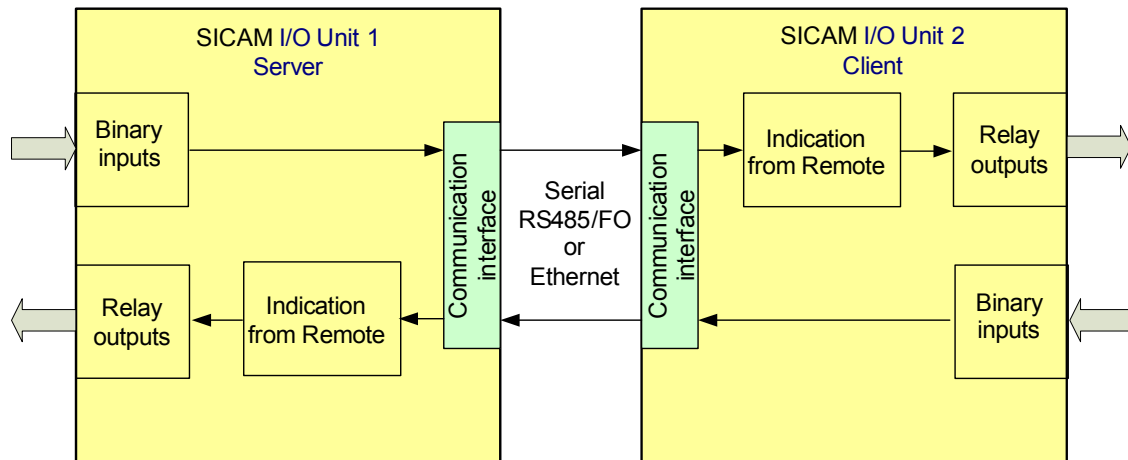

Figure 9-1 Application Example I/O Mirror



NOTE

The distance for the transmission of binary signals can be extended. This may be realized with the help of the following devices, for example:

- Optical Repeater 7XV5461
- RS485-FO Converter 7XV5650
- Communication Converter 7XV5662 (KU-KU, X.21/ G.703.1, G.703.6).

9.2 I/O Expansion

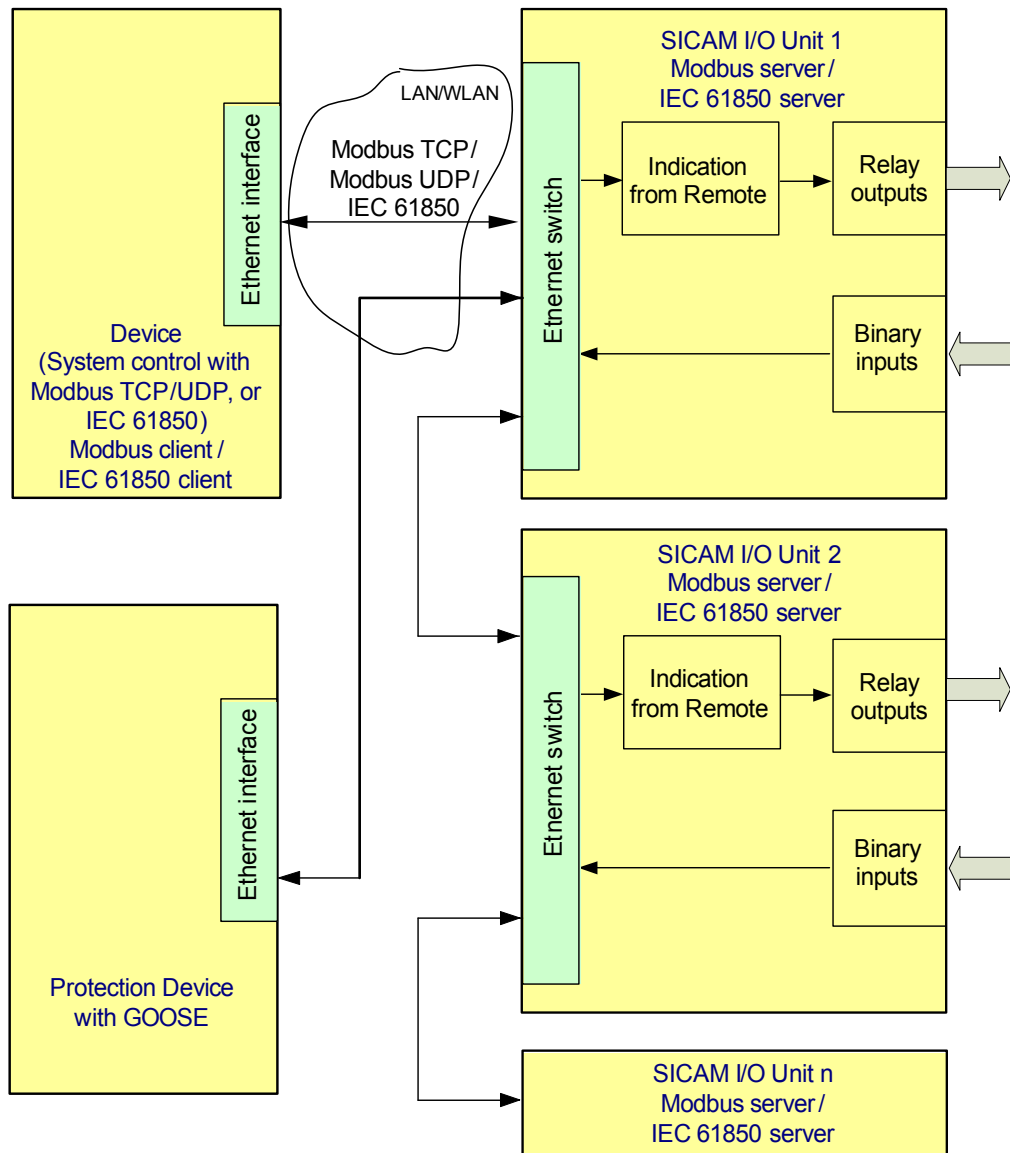

Figure 9-2 Acquisition and Output of Binary Signals with Connection to the Control System via Modbus or IEC 61850

The application for I/O expansion can also be realized via serial communication (RS485 [RS485 - bus system 7XV5103] or optical [optical starcoupler 7XV5450]) with an RTU Modbus protocol.

9.3 Contact Multiplier

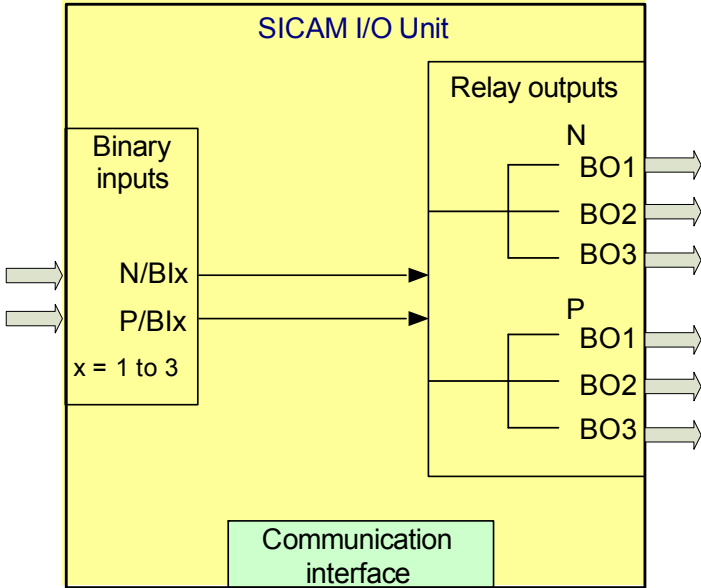

Figure 9-3 Application of a Contact Multiplier

For example, this application is used e.g. for the multiplication of signals at one or several binary inputs (BI1 to BI3) by command. The filter time for the binary inputs to increase the interference ratio of longer feed lines can be configured.

10 Interfaces

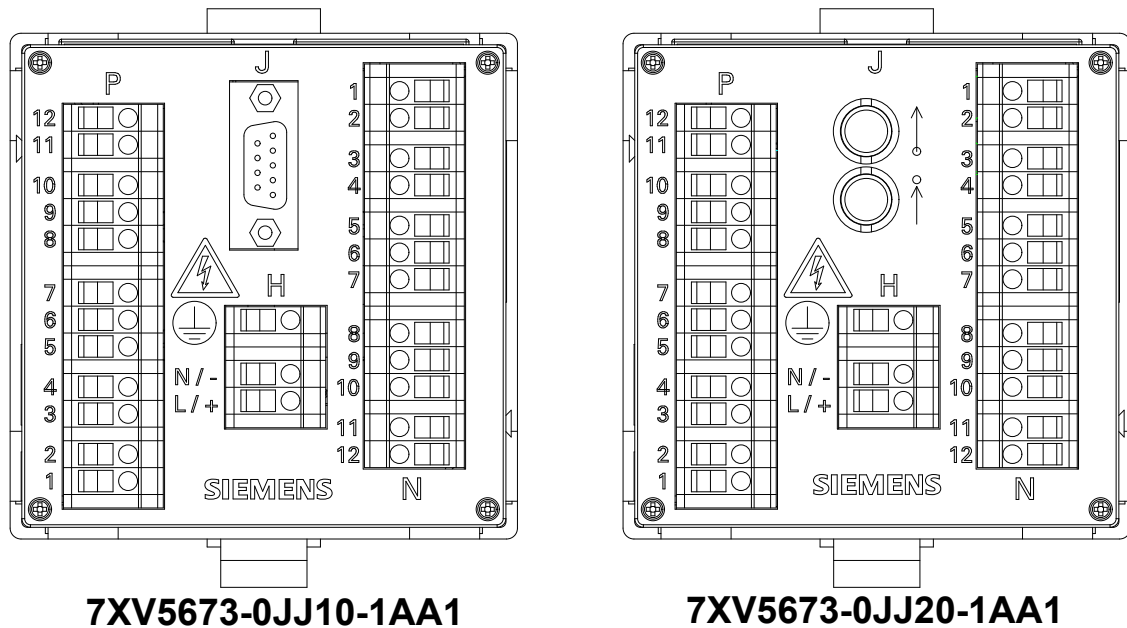

Figure 10-1 Connectors on the Terminal Side

Terminals for supply voltage (H) and binary inputs and outputs (N, P) on the terminal side:

Conductor cross-section	2.5 mm ² (AWG 14)
Conductor cross-section with bootlace ferrule	1.5 mm ² (AWG 16)
Tightening torque	0.4 Nm to 0.5 Nm (3.5 in-lb to 4.5 in-lb)

RS485 interface (J) on the terminal side of 7XV5673-0JJ10-1AA1:

RS485 cable with plug connector

820-nm FO interface (J) on the terminal side of 7XV5673-0JJ20-1AA1:

FO cable fitted with connector ST

Ethernet interface (Z) on the top side:

Ethernet patch cable with RJ45 connector or Y-cable if an Ethernet switch is used



DANGER

Danger due to high voltages

Non-observance will lead to death or serious injury.

- The protective earth terminal H  must be connected to the protective earth conductor of the switch board or the control cabinet.
-



DANGER

Danger due Laser radiation! Class 1

Non-observance will lead to death or serious injury.

- Do not look into the fiber-optic elements!
-

Terminal assignment

Table 10-1 Terminal Assignment of the SICAM I/
O Unit 7XV5673

Terminal	Function	Description
H 	Protective conductor	PE conductor terminal
H N / -	N/-	Neutral of the mains voltage / negative supply voltage
H L / +	L/+	Phase of the mains voltage / Positive supply voltage

Terminal	Function	Description
J	RS485 or optical	Serial interface: 7XV5673-0JJ10-1AA1 provided with an RS485 interface, 7XV5673-0JJ20- 1AA1 with an optical interface (FO).
Z	Ethernet interface	Ethernet connection; on the top side of the housing

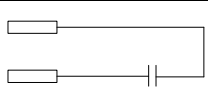
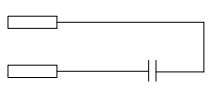
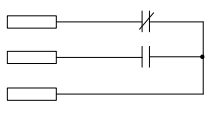
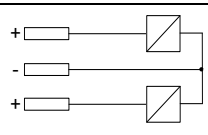
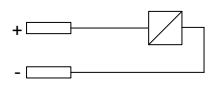
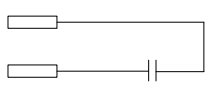
Terminal	Function	Description
Terminal block N		
N1 N2		Relay output 1, root Relay output 1, NO
N3 N4		Relay output 2, root Relay output 2, NO
N5 N6 N7		Relay output 3, NC Relay output 3, NO Relay output 3, root
N8 N9 N10		Binary input 1 Binary inputs 1+2 Binary input 2
N11 N12		Binary input 3 Binary input 3
Terminal block P		
P1 P2		Relay output 1, root Relay output 1, NO

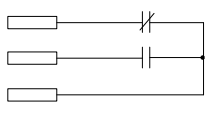
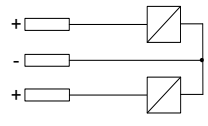
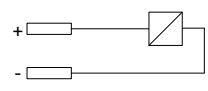
Terminal	Function	Description
P3 P4		Relay output 2, root Relay output 2, NO
P5 P6 P7		Relay output 3, NC Relay output 3, NO Relay output 3, root
P8 P9 P10		Binary input 1 Binary inputs 1+2 Binary input 2
P11 P12		Binary input 3 Binary input 3

Interference suppression capacitors at the relay contacts: ceramic, 4.7 nF, $\pm 20\%$, 250 V

Table 10-2 Assignment of RS485 Interface

Pin No.	Assignment	Pin No.	Assignment
1	Shield	6	DC +5 V
2	Not assigned	7	RTS
3	A	8	B
4	Not assigned	9	Not assigned
5	GND		

11 Replacing the Battery

The battery must be replaced if it is no longer charged sufficiently (avoid complete discharging). In this case, the operational indication "Battery Failure" is generated. This indication can also be configured to one of the 3 LEDs H1/H2/ERROR or to a relay output (see Device Manual SICAM I/O Unit 7XV5673, order number E50417-H1040-C484).



WARNING

Warning of incorrect treatment of the lithium battery (type PANASONIC CR2032 or VARTA 6032 101 501) or the use of an incorrect battery type. In the case of incorrect treatment or the wrong battery type, the battery may burn, explode or trigger a chemical reaction.

See product information for type of battery to be used.

Non-observance may lead to death or serious injury.

- ❑ Installing the battery or replacing it may only be carried out by trained personnel (see preface) who are familiar with and observe the safety requirements and precautions.
- ❑ Do not reverse the polarity of the battery.
- ❑ Do not attempt to open the battery.
- ❑ Do not attempt to recharge the battery.
- ❑ Servicing of the circuitry involving the batteries and replacement of the lithium batteries shall be done by a trained technician.
- ❑ Replace battery with VARTA 6032 101 501 or PANASONIC CR2032 only. Use of another battery may present a risk of fire or explosion. See manual for safety instructions.
- ❑ Caution: The battery used in this device may present a fire or chemical burn hazard if mistreated. Do not recharge, disassemble, heat above 100 °C (212 °F) or incinerate.
- ❑ Dispose of used battery promptly. Keep away from children.

When the "Battery Failure" indication is displayed, replace the battery as follows:

1. Lever the cover of the battery compartment out of the socket with a suitable tool (e.g. precision engineer screwdriver 2.0 mm).

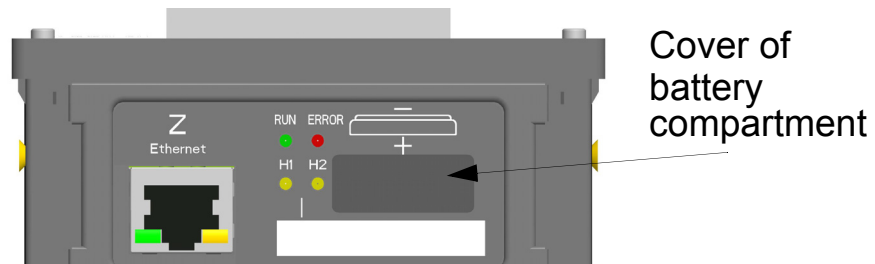

Figure 11-1 Removing the Cover of the Battery Compartment

2. Use an appropriate non-conducting tool (for example plastic tweezers) to pull the battery out of the compartment.



WARNING

Warning of explosion hazard in the case of batteries that are not fully discharged

Non-observance may lead to death or serious injury.

- To avoid a short circuit on the battery contacts, the battery may only be removed with a non-conductive tool.

3. Dispose the battery as explained in the NOTES on Battery Disposal.
4. Remove the new battery type PANASONIC CR2032 or VARTA 6032 101 501 from the packaging (check the expiry date on the packaging).
5. Insert the battery carefully into the battery compartment with the polarity indicated above the battery compartment.

-
6. Press the cover of the battery compartment back into the housing and make sure that it is in the correct position.



NOTES on Battery Disposal

The battery used in this device contains lithium. It may only be replaced by electrically qualified personnel and disposed by authorized recycling companies.

Do not dispose the battery in the regular household waste.

The national and international regulations must be observed when disposing the battery.

12 LED Indications

The SICAM I/O Unit 7XV5673 automatically monitors the functions of its hardware, software, and firmware components. The LEDs on the top side of the housing indicate the current device status.

Designation of the LEDs

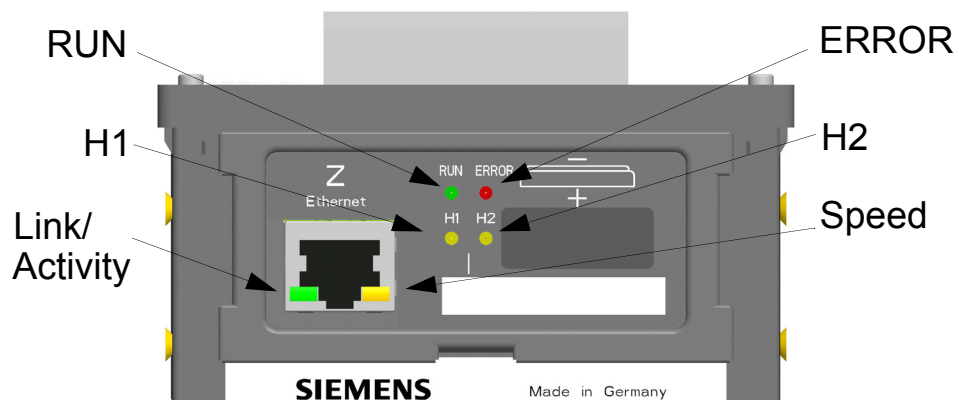











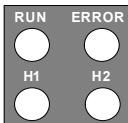
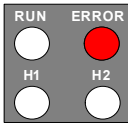
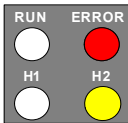
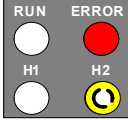
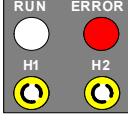
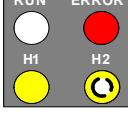

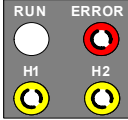
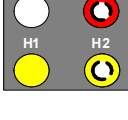
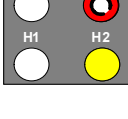
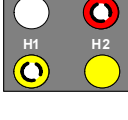

Figure 12-2 Designation of the LEDs

Meaning of the LEDs

-    LED (green, red, yellow): On
-    LED (green, red, yellow): Flashes
-   LEDs H1/H2/ERROR: According to parameterization
-  LED: Off
-  LED Speed (yellow): Off/On: 10/100 MBit/s
-  LED Link / Activity (green):
Lit: Ethernet link is up
Flashes: Ethernet link is up, data transmission
Off: No Ethernet partners connected

LEDs	Meaning
	Device switched off
	No firmware loaded
<i>Boot Loader</i>	
	IP-Addr. push-button pressed during power-on

LEDs	Meaning
	<p>Boot loader started after IP-Addr. push-button was pressed during power-on</p>
	<p>DHCP active (H1 switches off after reception of the IP address via DHCP)</p>
	<p>Default IP address by pressing the IP-Addr. push-button</p>
	<p>Boot loader started; no process application exists.</p>
	<p>DHCP active (H1 switches off after reception of the IP address via DHCP)</p>
	<p>Default IP address by pressing the IP-Addr. push-button</p>
	<p>Boot loader was started because an error occurred in the process application.</p>
	<p>DHCP active (H1 switches off after reception of the IP address via DHCP)</p>

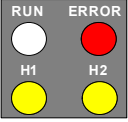
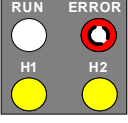
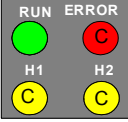
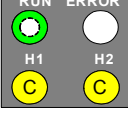
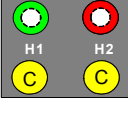
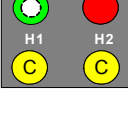
LEDs	Meaning
	Boot loader started, process application is being loaded.
	Double IP address is detected.
<i>Process Application</i>	
	Normal mode IP address has been configured or received from DHCP.
	DHCP (LED RUN (green) is lit after the IP address is received by the DHCP server)
	Default IP address is applied by pressing the IP-Addr. push-button.
	Double IP address is detected.

13 Troubleshooting and Repair

The user is **not authorized** to repair the device when it is defective. This is because the device contains special electronic components that may only be handled by the manufacturer in compliance with the regulations for electrostatic sensitive devices (ESD).

If you suspect that the device has a defect, Siemens recommends to send the entire device back to the manufacturer. If possible, use the original transport packaging or an equivalent packaging.

14 Storage and Transport

Storage

Store the device in a dry and clean location. The temperature range for storing the device or any of its replacement modules is -25 °C to +70 °C (-13 °F to +158 °F).

The air relative humidity must not lead to condensation or ice formation.

To avoid premature aging of the electrolytic capacitors, store the device within the recommended temperature range of +10 °C to +35 °C (+50 °F to +95 °F).

If the device is stored for an extended time, Siemens recommend to connect the device to the supply voltage for one or 2 days once a year, to reform the electrolytic capacitors in the device. This procedure should be carried out before operating the device. In this context, pay attention to the commissioning notes in Chapter 8.

The Lithium-batteries in our equipment are subject to Special Provision 188 of the UN Recommendations on the Transport of Dangerous Goods Model Regulations and Special Provision A45 of the IATA Dangerous Goods Regulation and the ICAO Technical Instructions. This is only valid for the original battery or original spare batteries.

Transport

If devices are to be shipped elsewhere, you can reuse the transport packaging. When using different packaging, you must ensure that the transport requirements according to ISO 2248 are adhered to. The storage packing of the individual devices is not adequate for transport purposes.

15 Technical Data (Selection)



NOTE

For detailed information about the technical data, please refer the Device Manual SICAM I/O Unit 7XV5673, order number E50417-H1040-C484.

15.1 Binary Inputs

Maximum input voltage	300 V
Logic levels of the input voltages	
□ At threshold voltage 19 V (for nom. voltage 24 V)	$U_{IH} \geq 19 \text{ V}$ $U_{IL} \leq 10 \text{ V}$
□ At threshold voltage 88 V (for nom. voltage 110 V)	$U_{IH} \geq 88 \text{ V}$ $U_{IL} \leq 44 \text{ V}$
□ At threshold voltage 176 V (for nom. voltage 220 V)	$U_{IH} \geq 176 \text{ V}$ $U_{IL} \leq 88 \text{ V}$

15.2 Relay Outputs

Switching capacity	On: 1000 W/VA Off: 30 VA; 40 W ohmic 25 W/VA at $L/R \leq 40 \text{ ms}$
Contact voltage	AC 250 V, DC 250 V
Permissible current per contact	continuous: 5 A switching on and holding: 30 A for 1 s (make contact)
Short-time current across closed contact	250 A at 30 ms
Total permissible current for contacts connected to common potential	5 A

Switching time (OOT) ≤ 5 ms (OOT = Output Operating Time) additional delay of the output medium used

Rated data of the output contacts

120 V ac 5.0 A, GP

277 V ac 5.0 A, GP

277 V ac 0.7 HP

B300

R300

Anti-interference capacitors across the contacts

4.7 nF, ± 20 %, AC 250 V

15.3 Insulation Test According to IEC 60255-27, IEC 61010-1 and IEC 60870-2-1; Insulation reinforced; Category Cat. III

Test	Test Values
Voltage test (routine test) of - auxiliary voltage - binary inputs and relay outputs	DC 3.6 kV AC 3.25 kV, 50 Hz
Voltage test (routine test) of isolated communication ports only - J (RS485) - Z (Ethernet)	AC 500 V, 50 Hz DC 700 V
Impulse voltage test (type test) of all process circuits (except for communication ports) against the internal electronics	6 kV (peak value); 1.2 μ s/50 μ s; 0.5 J; 3 positive and 3 negative impulses at intervals of 1 s
Impulse voltage test (type test) of all process circuits against each other (except for communication ports) and against the PE terminal of class III	5 kV (peak value); 1.2 μ s/50 μ s; 0.5 J; 3 positive and 3 negative impulses at intervals of 1 s

15.4 Ethernet

Protocols	Modbus TCP Modbus UDP IEC 61850
Transmission rate	10/100 MBit/s
Communication protocol	Ethernet acc. to IEEE 802.3
Connection	100Base-T (RJ45)
Cable for 100Base-T	100 Ω to 150 Ω STP, CAT5
Max. cable length 100Base-T	100 m (if routed well)
Voltage strength	DC 700 V

15.5 Serial Interface

Connections	
RS485	9-pin D-Sub plug connector
max. line length	1000 m, three-wire, twisted, shielded
FO	ST plug, 820 nm
max. FO length	2000 m at 62,5/125 μm FO
receiver sensitivity	-24 dBm at 62,5/125 μm FO
optical budget	min. 8 dB at 62,5/125 μm FO

Bus protocol	Modbus RTU
Adjustable baud rates at Modbus RTU	1200 bit/s 2400 bit/s 4800 bit/s 9600 bit/s 19 200 bit/s 38 400 bit/s 57 600 bit/s 115 200 bit/s
Adjustable baud rates at I/O mirror	1200 bit/s 2400 bit/s 4800 bit/s 9600 bit/s 19 200 bit/s 38 400 bit/s 57 600 bit/s 115 200 bit/s 187 500 bit/s

15.6 Supply Voltage

Rated input voltages	AC 110 V to 230 V DC 24 V to 250 V
Frequency at AC	45 Hz to 65 Hz
Admissible input voltage tolerance (applies to all input voltages)	±20 %
Maximum power consumption	6 W/12 VA

15.7 Battery

Type	PANASONIC CR2032 or VARTA 6032 101 501
Voltage	3 V
Capacity	230 mAh
Typical life time	
at permanently available power supply	10 years
at not permanently available power supply	2 month within 10 years

15.8 Environmental Data

Open type; surrounding air temperature:

tsurr: max. 70 °C (158 °F)

Operating temperature	-25 °C to +70 °C -13 °F to +158 °F
-----------------------	---------------------------------------

Temperature

□ during transport	-25 °C to +70 °C -13 °F to +158 °F
--------------------	---------------------------------------

□ during storage	-25 °C to +70 °C -13 °F to +158 °F
------------------	---------------------------------------

recommendation	+10 °C to +35 °C +50 °F to +95 °F
----------------	--------------------------------------

Mean relative humidity	≤ 75 %
------------------------	--------

Condensation

□ during operation	not admissible
--------------------	----------------

□ transport and storage	admissible
-------------------------	------------

15.9 Additional Technical Data

Internal fuse	not replaceable type T1.6A/250V according to IEC 60127
Internal fuse, secondary	not replaceable type F2A/125V according to UL 248-14

15.10 Protection Class According to IEC 60529

Terminal side	IP20
DIN rail side	IP20
Top side	IP20

15.11 Dimensions

Mass	approx. 0.550 kg
Dimensions (W x H x D)	96 mm x 96 mm x 100 mm 3.78 inch x 3.78 inch x 3.94 inch

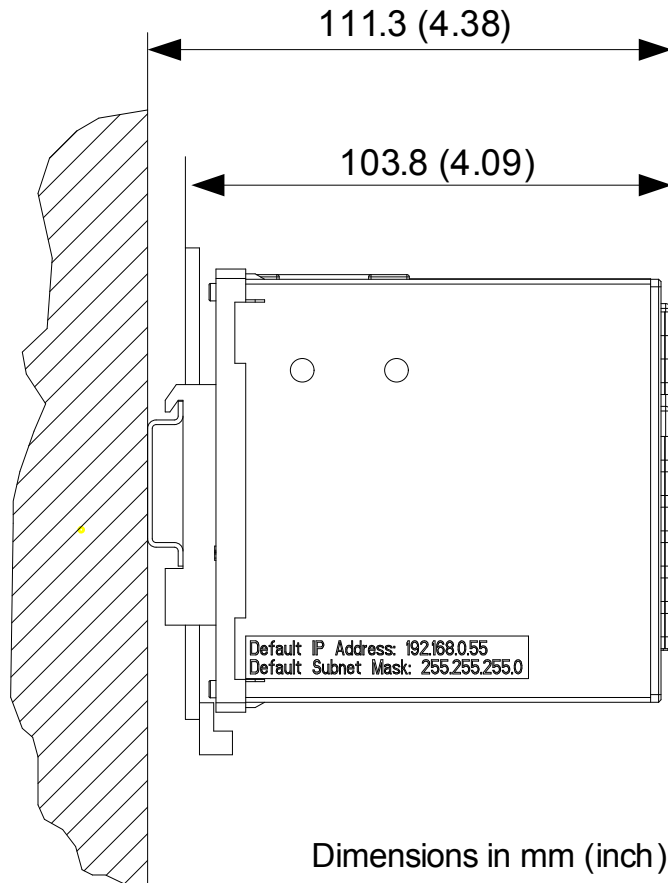

Figure 15-1 Dimension

