

## Temperature detection SIPROTEC V4 via RTD box

The number of applications for SIPROTEC V4 devices is becoming more and more varied. Up to two temperature units (RTD-boxes) with 12 temperature sensors in total can be applied at SIPROTEC 4 devices for temperature detection and are recognized by the device. 7SJ602 can indicate 6 temperatures. The type of sensor can be Pt 100 Ohm, Ni 120 Ohm or Ni 100 Ohm.

### 1. Temperature detection with 1 RTD box

Following parts are necessary:

- **Protection relay with ordering option for temperature detection**  
at present: 7UM62, 7SJ602, 7SJ61/62/63/64, 7UT612, 7UT613, 7UT63x
- **RTD box** 7XV5662-2AD10-0000 (AC/DC 24-60V) or  
7XV5662-5AD10-0000 (AC/DC 90-240V)
- **Connection cable:** 7XV5103-7AAxx (xx = Length 05 / 25 / 50 m)

Optionally: Auxiliary voltage for RTD box

- **Wide-range Power Supply:** 7XV5810-0BA00

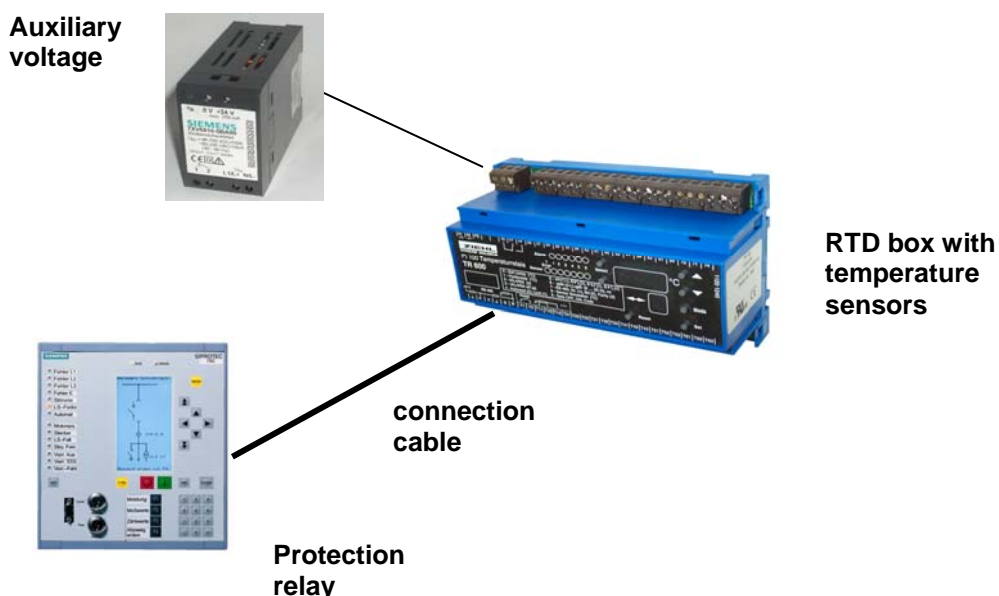

Picture 1: Overview for the application of RTD box

### 1.1. Connection protection device

7SJ602 offers the connection to RTD box on bottom of the unit.

7UM62, 7UT612, 7SJ61/62/63/64 offer the connection to RTD box via the service port at rear side of the relays (port C, with RS485 or fiber optic).

The protection relays 7SJ64 and 7UM62 offer besides port C an additional port (port D, with RS485 or fiber optic) that can be used for RTD box.

(In case of fiber optic connection a separate RS485/LWL converter 7VX5650 must be used in addition to the cables listed below, the RTD box transmits only RS485, connection examples see last page.)

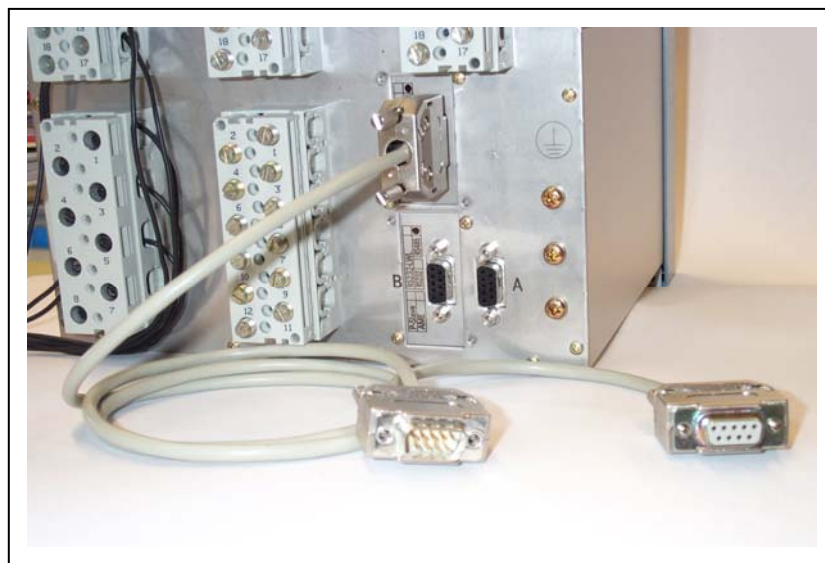

Picture 2: Connection to service port at rear side (port C )

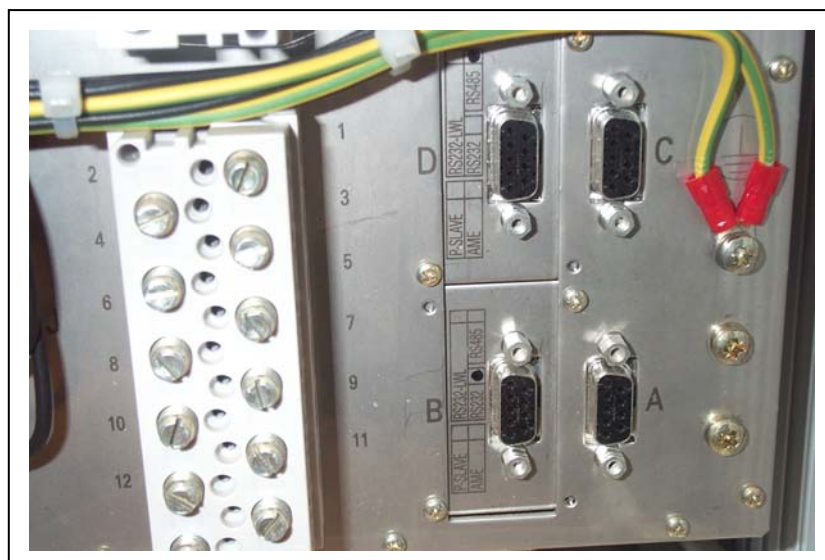

Picture 3: ONLY 7UM62 AND 7SJ64: Connection to port D also possible

The RTD-box is connected via a RS485-interface to one SIPROTEC 4 bay device with thermo function (e.g. 7SJ6, 7UT6, 7UM6) or to the compact protection 7SK80 via a serial RS485-interface (Port B). The special cable 7XV5103-7AAxx is used for the connection.

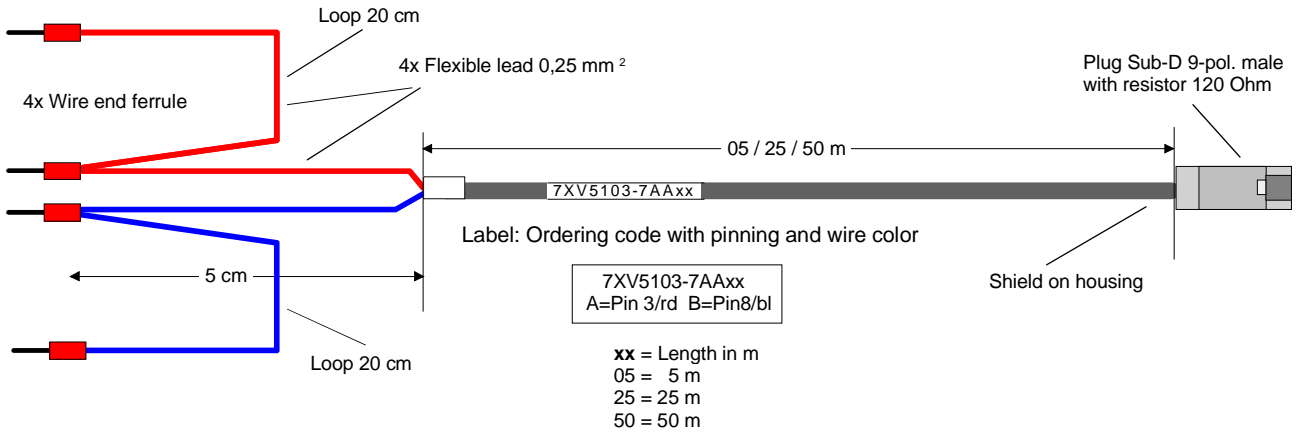

Picture 4: Cable 7XV5103-7xx for RS485-bus with 9-pol. Sub-D plug

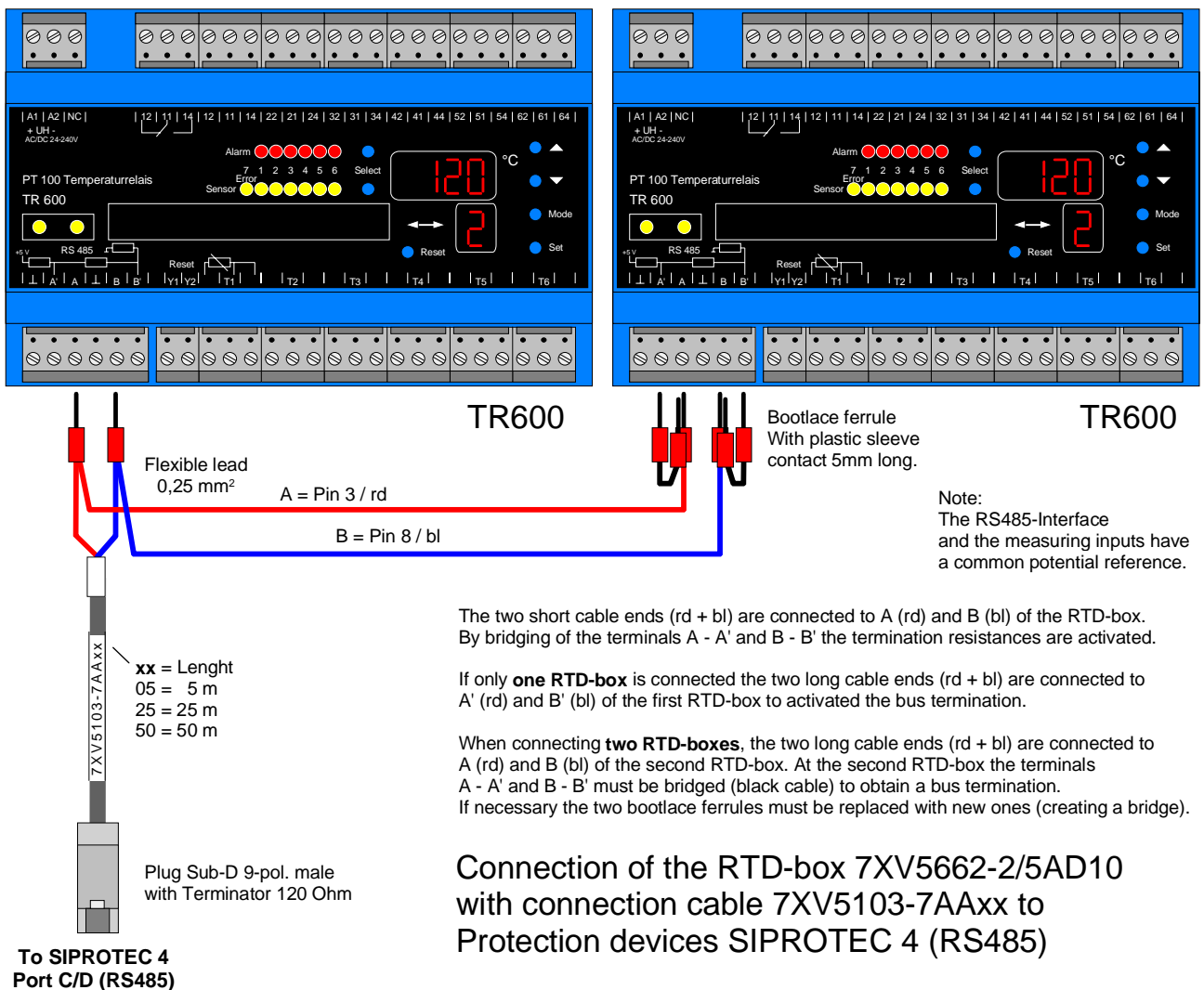

Picture 5: Connection RTD-box to SIPROTEC 4

1.2 RTD-box TR600

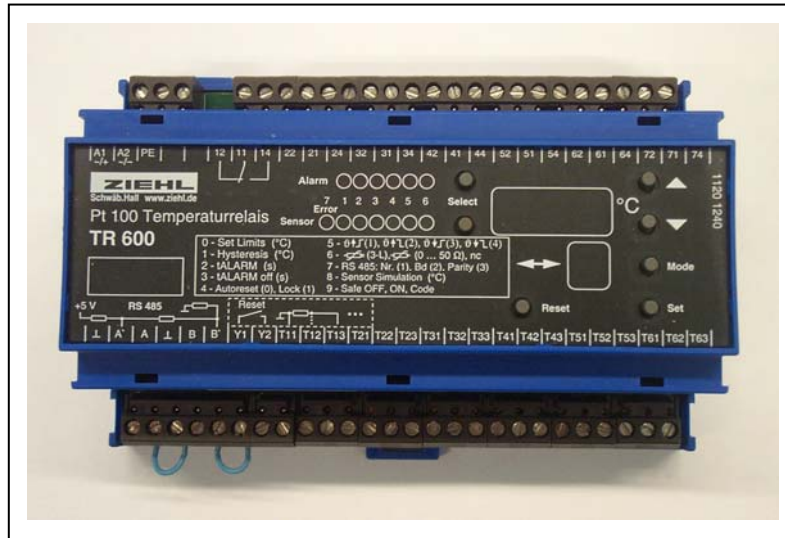

7XV5662-2AD10(AC/DC 24-60V)  
7XV5662-5AD10 (AC/DC 90-240V)

Bild 6: RTD-box 7XV5662-2AD10

Picture 7 shows the wiring of the RTD box.

A maximum of 6 temperature sensors is available in one RTD box.

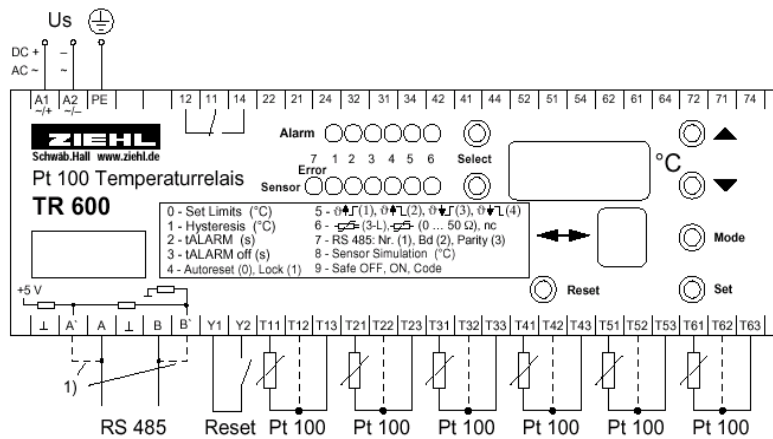

1) Loop for termination resistor

Picture 7: RTD-box connection

Individual setting parameters are described in the manual of the RTD box. Settings on the RTD box have to be done by the “Mode” button. Press the button “Mode” several times until the desired menu appears.

Important is the type of connection of the temperature sensors (2 – or 3-wire connection, settable in mode 6) and the address of the RTD box (necessary for detection at protection relay, settable in mode 7 ). For half duplex mode the address has to be set to “1”. In case of using two RTD boxes the first box gets address “1”, the second box address “2”.

The baud rate and data format of SIPROTEC-devices for the communication with RTD-box is fix preconfigured with 9600 / 8E1. The communication interface of the RTD-box must be set according these values.

The type of sensor can be Pt 100 Ohm, Ni 120 Ohm or Ni 100 Ohm. The RTD box only correctly processes PT 100 values, Ni 120 and Ni 100 measured values are displayed incorrectly at the RTD box. The SIPROTEC 4 relay transforms these „wrong“ measurands into correct values and displays them correctly at SIPROTEC side. Therefore you must choose the type of sensor in the setting parameters of the protection relay (see picture 9).

**1.3 Parameters of protection relay**

At the protection relay you have first to choose the type of connection for the RTD-box. Open in DIGSI the device configuration and then go to address 0191.

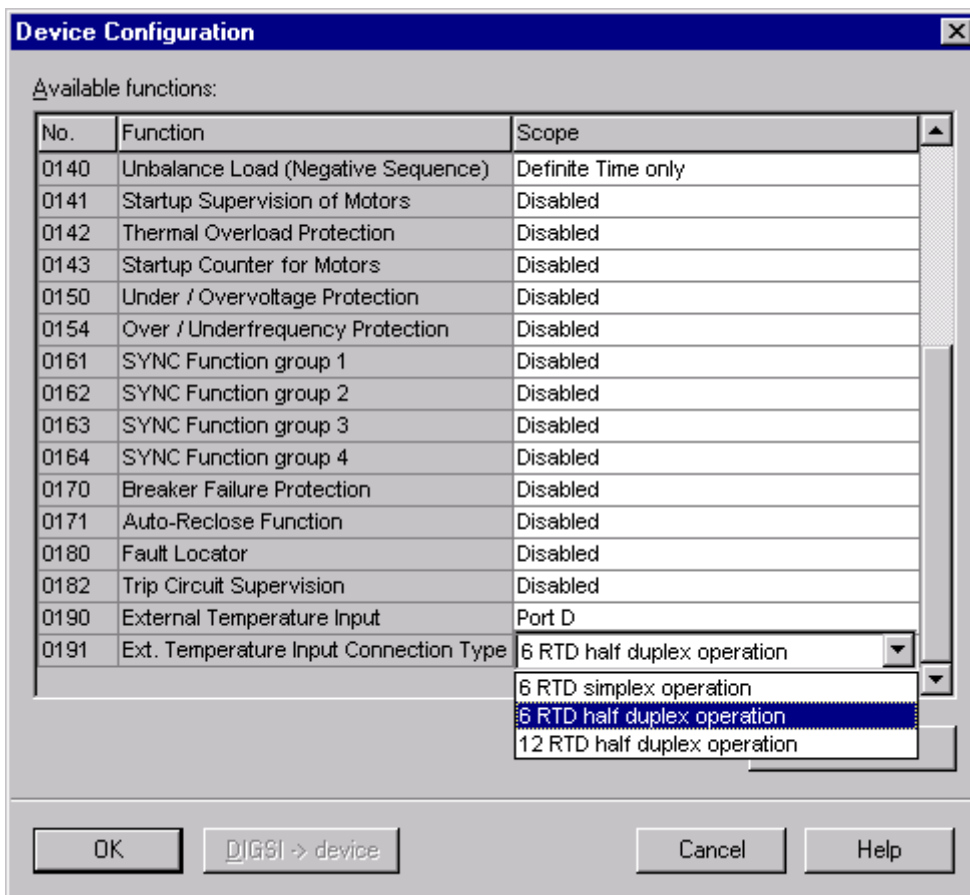

Picture 8: Device configuration of protection relay (7SJ64)

Afterwards go to the setting group and open the RTD box settings. All temperature setting parameters will appear.

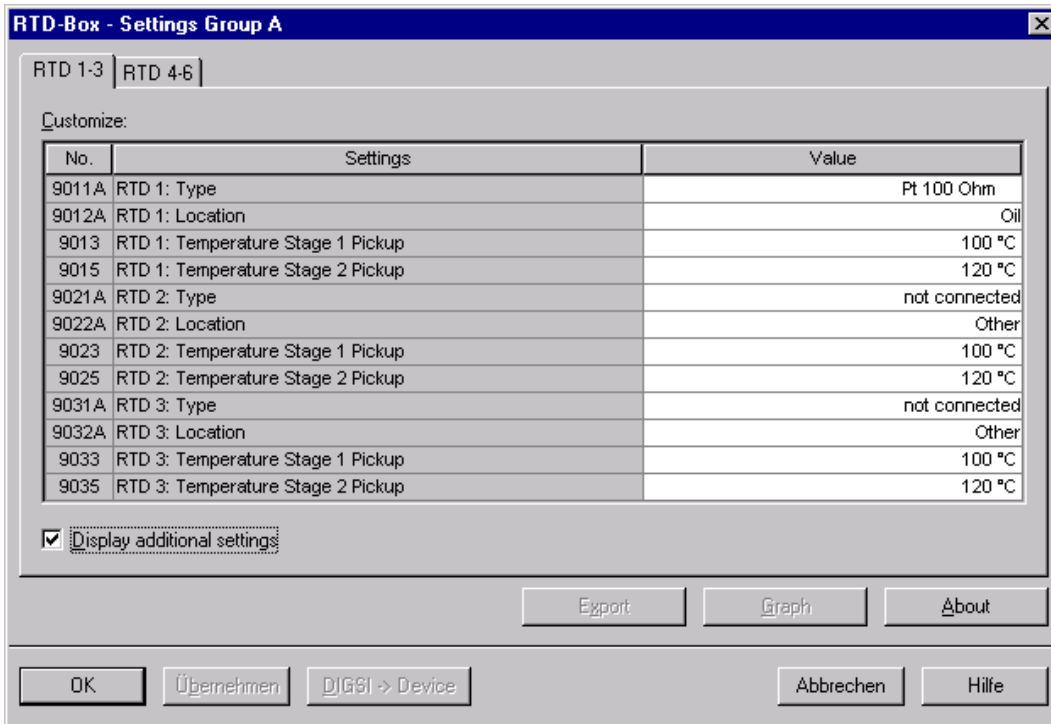

Picture 9: Settings (thresholds, type of sensor)

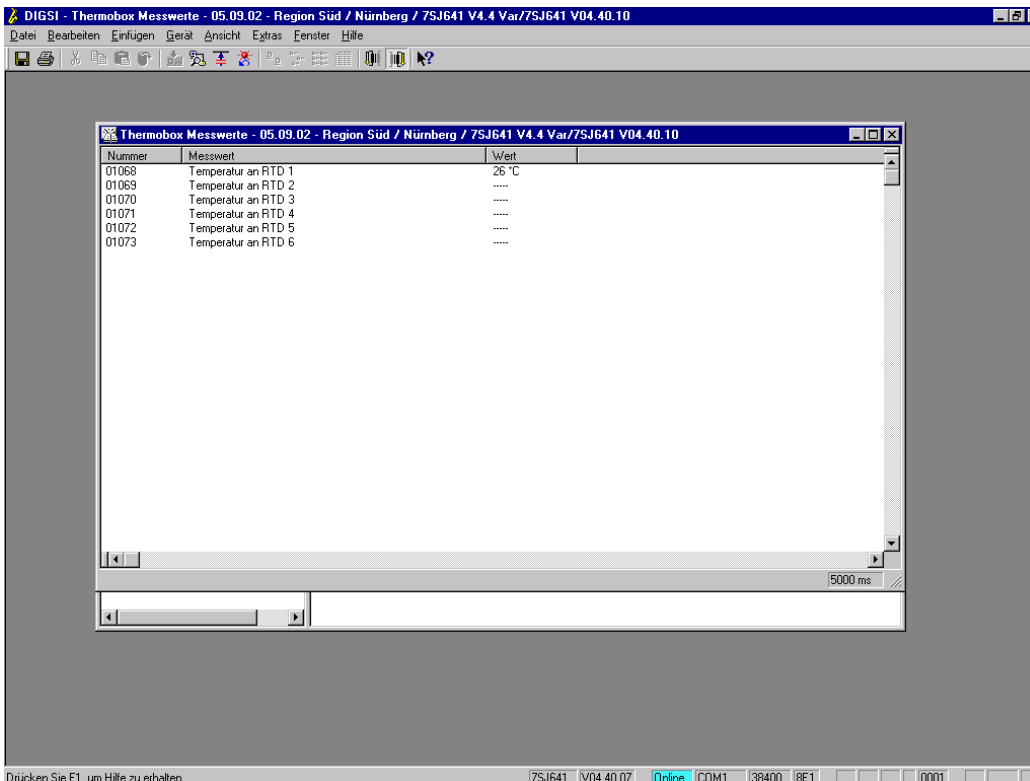

Picture 10: Indication of temperature in the measurement window

Further information is available in the manual of the protection relay in the chapter for temperature detection.

**2. Temperature detection with 2 RTD boxes:  
SIPROTEC4 relays 7UM62, 7SJ/61/62/63/64, 7UT612, 7UT613, 7UT63x**

Please notice that the addresses of the RTD boxes have to be different (first box gets address “1”, the second box address “2”, settable direct at the box , mode 7). After changing the device configuration in DIGSI for 2 RTD units (see picture 12) the function RTD box offers now 12 temperature values with 2 thresholds for each temperature.

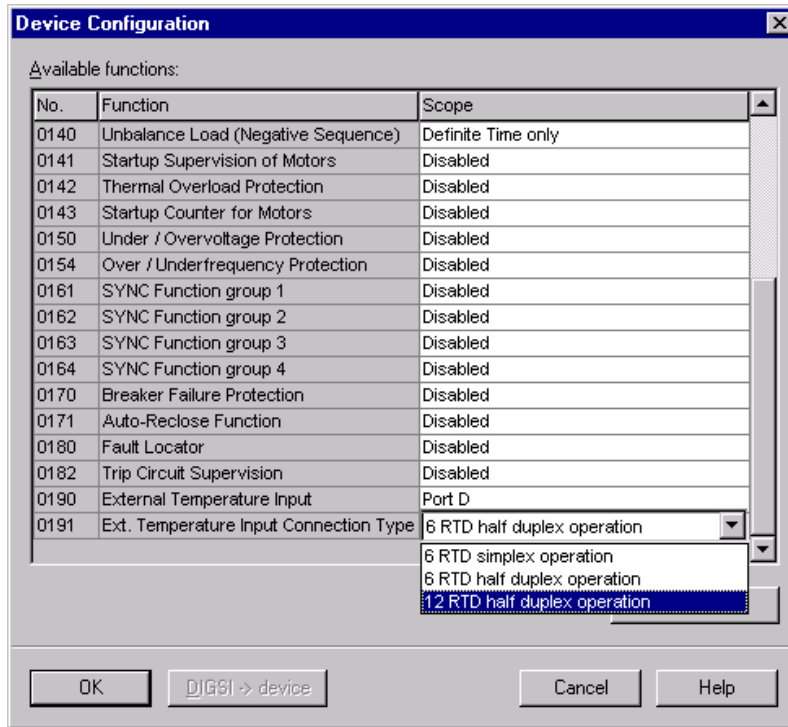

Picture 12: Device configuration for 2 RTD boxes

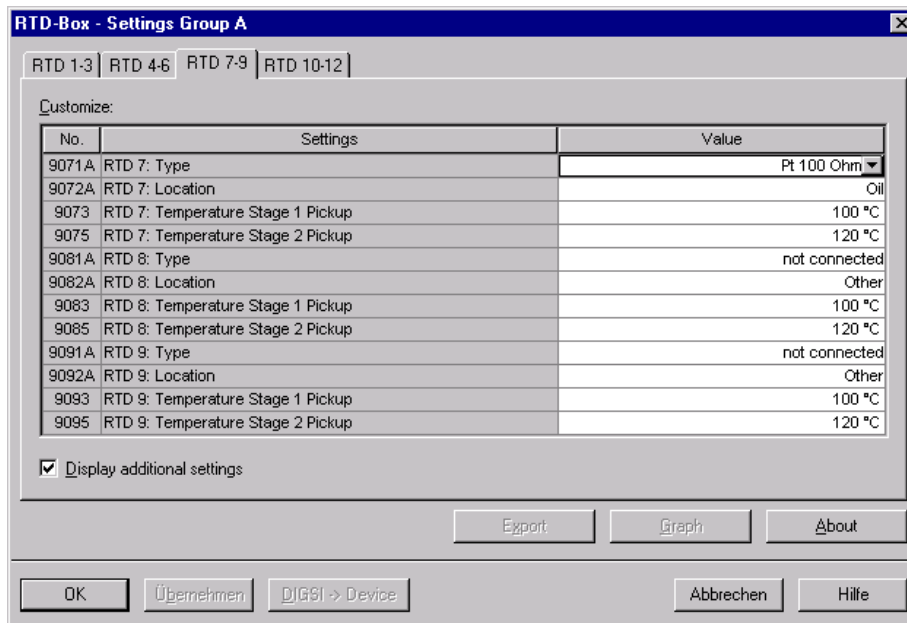

Picture 13: Setting of parameters



3. Further connection possibilities

e.g. 7UM62, connection to port C or port D

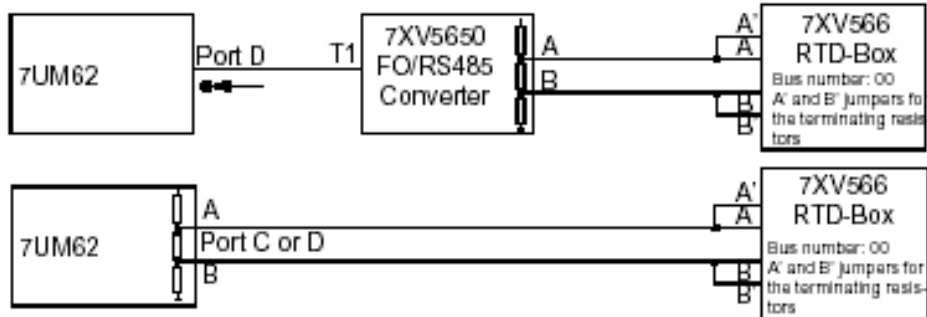

Figure A-40 Simplex operation with one RTD-Box  
above: optical design (1 FO); below: design with RS485

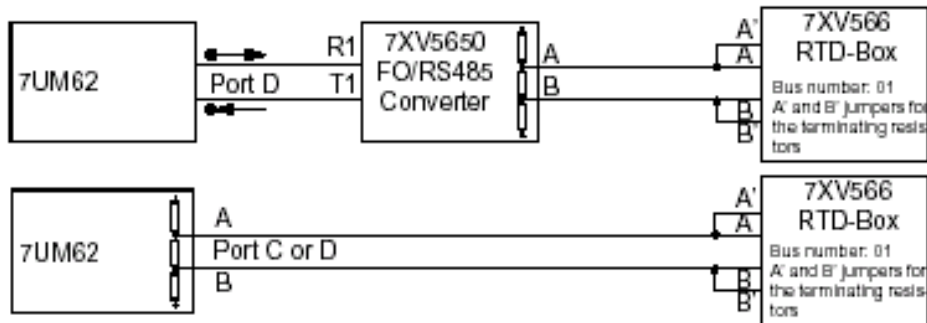
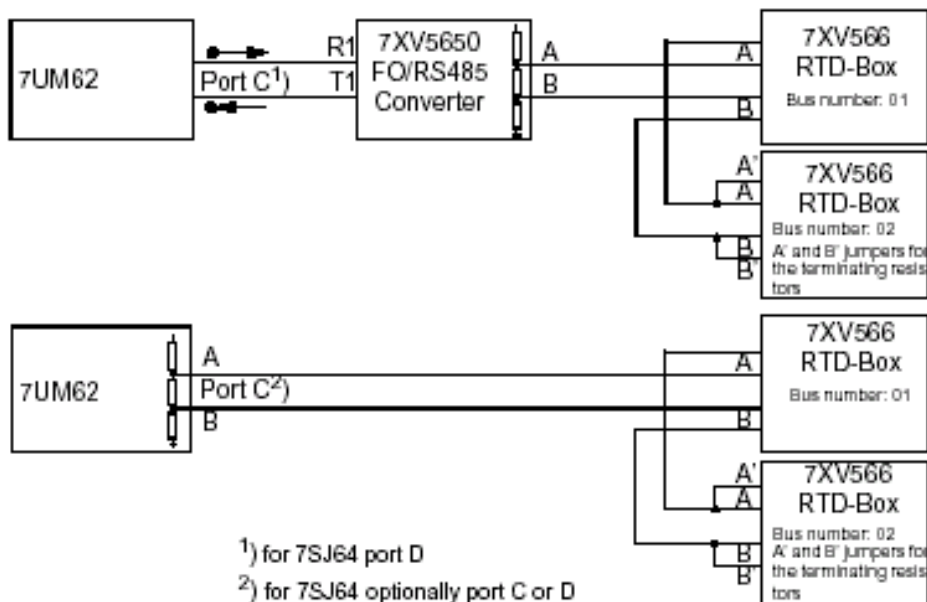

Figure A-41 Half-duplex operation with one RTD-Box  
above: optical design (2 FOs); below: design with RS485



<sup>1</sup>) for 7SJ64 port D  
<sup>2</sup>) for 7SJ64 optionally port C or D

Figure A-42 Half-duplex operation with two RTD-Boxes  
above: optical design (2 FOs); below: design with RS485