

IF IN DOUBT ASK
DO NOT SCALE

A

B

C

D

E

F

BUSBARS

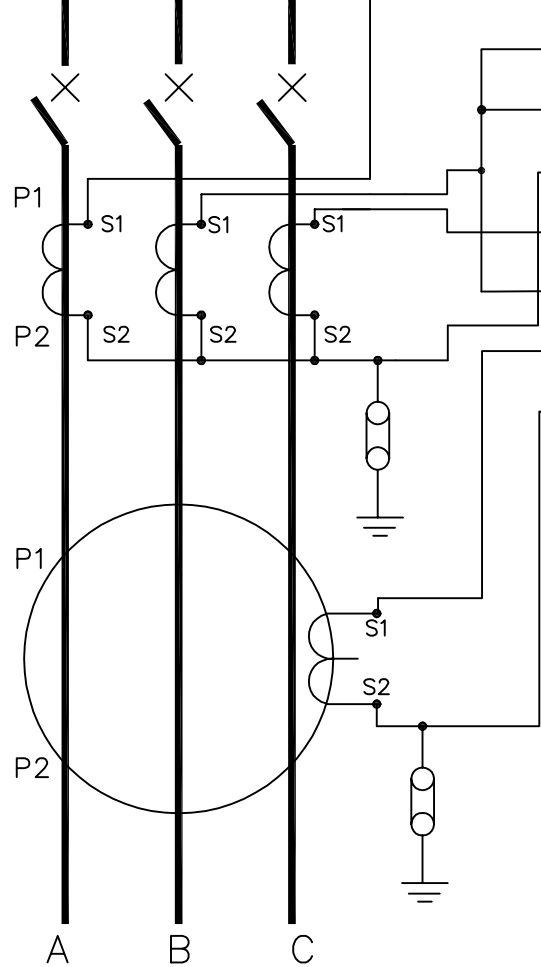

DCD42xB(ARGUS 1)MODULAR SIZE 6 CASE

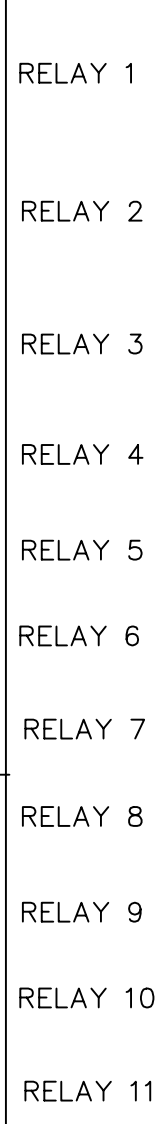
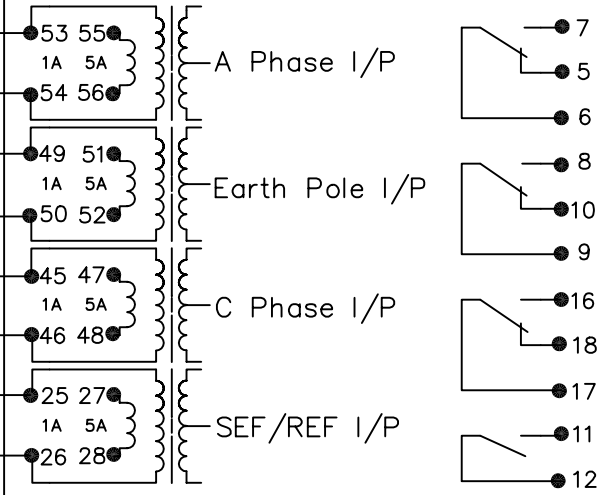

EXPANSION PCB

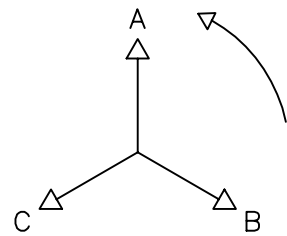
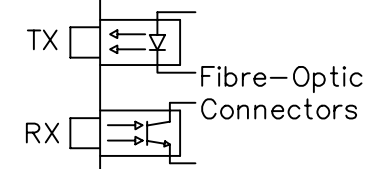
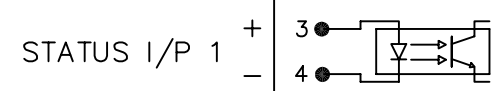
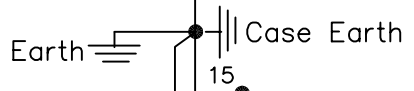
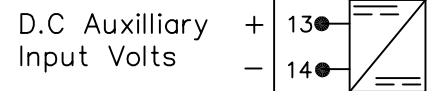

PHASE ROTATION

MATERIAL:

Dimensions in millimetres : Surface texture in micrometres.
Machine where marked ✓
For explanation of dimensions, tolerances, notes etc. see B.S.308.
Limit on untoleranced unmachined dimensions ± _____
Limits on untoleranced machined dimensions to B.S.4500;
i.e. up to 6±0.1; over 30 to 120±0.3; over 315±0.8;
over 6 to 30±0.2; over 120 to 315±0.5;
General unmachined angular tolerance ± _____

Finish: _____
Treatment: _____

Title: TYPICAL SCHEMATIC DIAGRAM FOR 2P+E/F+SEF
(CORE BALANCE CT) NUMERIC O/C PROTECTION
(ARGUS 1) EPSILON CASE

**Reyrolle Protection
Hebburn.**

Original Scale: NTS

First used on: _____
Similar Articles: 2434W10019
Supersedes: _____
Drg. No. **2434W10061**

DRAWN M LEASK	CHECKED	APPROVED R.D.WATSON	DATE 23/07/02	IE	OPS	PCP	Purch.Spec. TQ	EAC	CE	STD	A3
---------------	---------	---------------------	---------------	----	-----	-----	----------------	-----	----	-----	----

TERMINAL BLOCKS VIEWED FROM REAR

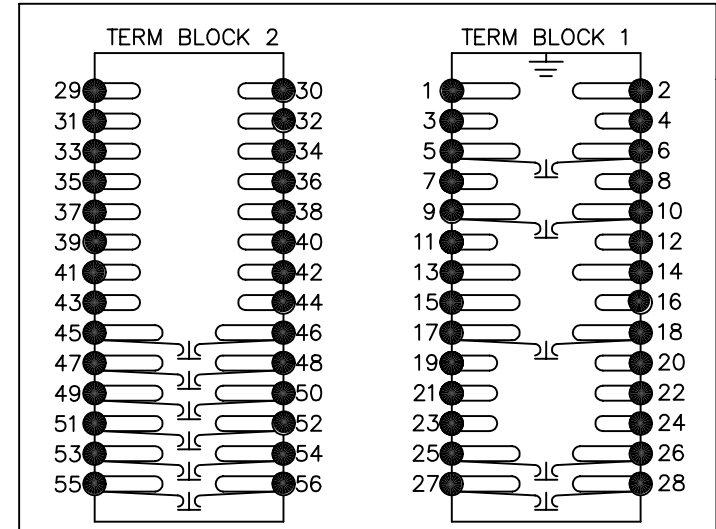

KEY

- 1 Short Terminals
- 2 Long Terminals
- 3 CT Shorting Links

NOTES

- 1 CT CIRCUITS ARE SHOWN CONNECTED TO RELAY 1 AMP TAP.USE ALTERNATIVE TAP FOR 5AMP RATED CTs.
- 2 CT & EARTH CONNECTIONS ARE TYPICAL ONLY.
- 3 FOR TERMINAL DIAGRAM SEE 2716W20001 (A2)
- 4 DRG SHOWS OPTION A (7 OUTPUTS,1 INPUT)
DRG SHOWS OPTION B (11 OUTPUTS,5 INPUTS)

NOT SUBJECT TO UPDATE
ONCE COPIED / PRINTED
OR DOWNLOADED

3	18/4/02	MN434/2292
2	11/4/00	MN434/160
1	22/11/99	CHANGE NOTED

Copyright © 1999 Reyrolle Ltd.