

**IF IN DOUBT ASK
DO NOT SCALE**

EU EXPORT CONTROLS ECCN: N AL: N
This document is not Export Controlled unless sending to Critical Countries.

Relay Earthing

Terminal B28 of the PSU should be earthed by a direct connection to the device case earth stud (GND).

The device case earth stud should be solidly earthed by a direct connection to the panel earth.

Terminal contacts internal to case assembly close when device is withdrawn from case.

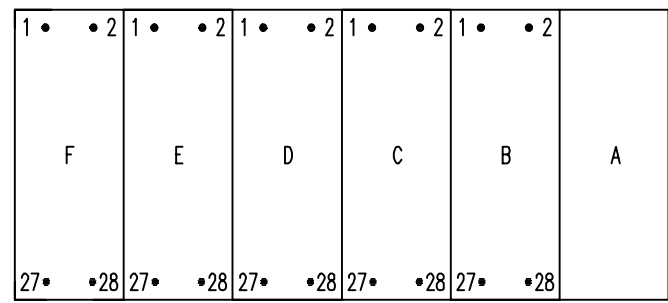

VIEWED FROM REAR

Warning – Eye Safety

Connectors X11–X13 are Laser class 1 (LED radiation only) products.

Notes – Ethernet Options

Device will be fitted with either 2 x electrical (RJ45) or 2 x optical (LC) ethernet ports.

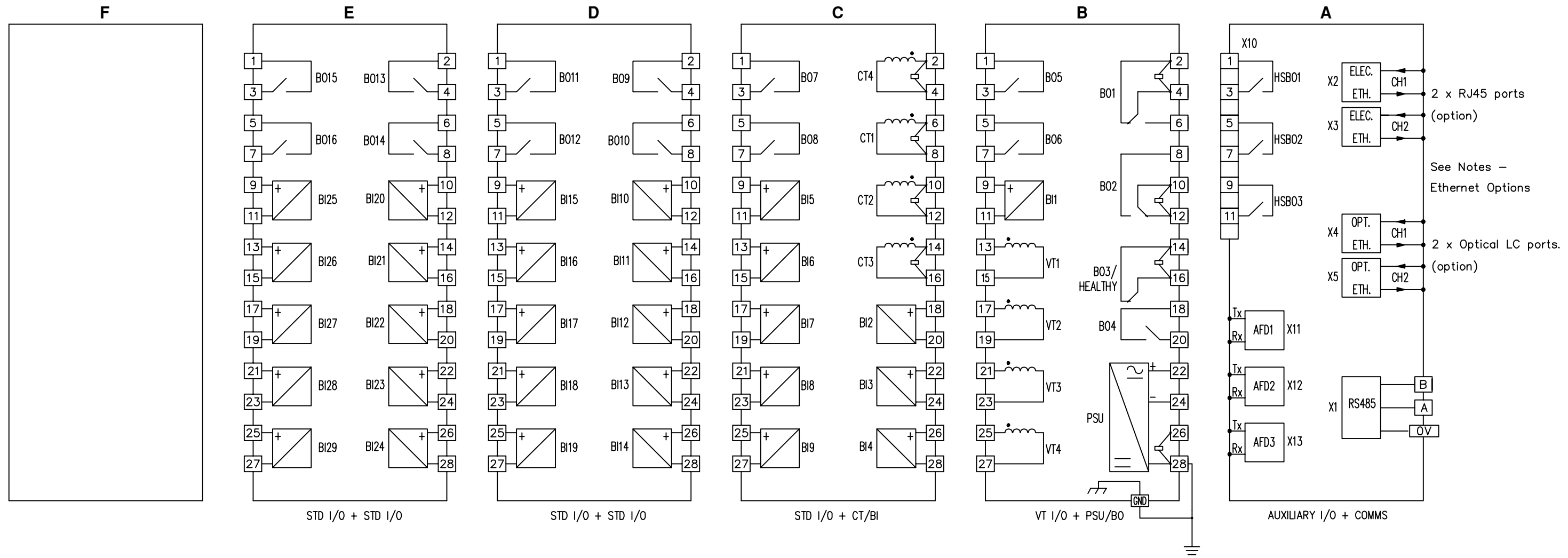

ABBREVIATIONS	
AFD	ARC FLASH DETECTOR
BI	BINARY INPUT
BO	BINARY OUTPUT
COMMS	COMMUNICATIONS
CT	CURRENT TRANSFORMER
ELEC	ELECTRICAL
ETH	ETHERNET
GND	GROUND (CASE EARTH STUD)
HSBO	HIGH SPEED BINARY OUTPUT
OPT	OPTICAL
PSU	POWER SUPPLY UNIT (AUXILIARY)
STD I/O	STANDARD INPUT/OUTPUT
VT	VOLTAGE TRANSFORMER

**NOT SUBJECT TO UPDATE
ONCE COPIED / PRINTED
OR DOWNLOADED**

2 NC	21/04/21	3Z2000249 JS
1	27/05/20	CHANGE NOTED
ISSUE	DATE	

Finish: —	Title: REAR TERMINAL CONNECTIONS—7SR5[1,7]11—5ADx6—0AA0 4CT, 4VT, 29BI, 16BO, 3AFD, 3HSBO	First used on: —
Treatment: —	SIEMENS PLC	Similar Articles: —
		Original Scale: NTS
Drawn: J SPOWART	Checked: K.H	Dwg No. 2518W50105
Approved: N CAMPBELL	Date: 08/06/20	Copyright © 2020 A3 SIEMENS PLC. Hebburn