

SIEMENS

Power Meter

SIMEAS P 7KG7750/55

Communication Protocol

IEC 60870-5-103

Manual

Foreword

Table of Contents

Firmware Versions

1

Parameters and Properties

2

Data Mapping

3

Technical Data

4

Glossary, Index



**Note**

Please observe the instructions and warnings for your safety in the foreword.

Disclaimer of Liability

We have checked the contents of this document and every effort has been made to ensure that the descriptions of both hardware and software are as accurate as possible. However, since deviations cannot be ruled out entirely, we do not accept liability for complete conformity or for any errors or omissions. The information in this manual is checked periodically, and necessary corrections will be included in future editions. We are grateful for any improvements that you care to suggest.

Subject to technical alterations.
Document version V01.11.01
Release 01.2009

Copyright

Copyright © Siemens AG 2009

This document shall not be transmitted or reproduced, nor shall its contents be exploited or disclosed to third parties without prior written consent from Siemens. Offenders will be liable for damages. All rights, including rights created by patent grant or registration of a utility model or design, are reserved.

Registered Trademarks

SIPROTEC[®], DIGSI[®], OSCOP[®] and SIMEAS[®] are registered trademarks of SIEMENS AG.

Other designations in this manual might be trademarks whose use by third parties for their own purposes would infringe the rights of the owner.

Foreword

Purpose of this manual

The manual describes the functions, bus specific parameters, parameterization and the hardware interface of the IEC 60870-5-103 slave of the device SIMEAS P50 and is divided into the following topics:

- Firmware Versions → Chapter 1
- Parameters and Properties → Chapter 2
- Data Mapping → Chapter 3
- Technical Data → Chapter 4

General details about the function, operation, assembly and commissioning of the SIMEAS P50 devices you find in the following manuals:

Manual	Order number
SIMEAS P 7KG7750/55 Device Manual	E50417-B1076-C340
SIMEAS P50 Application Description Firmware Update	E50417-X1074-C376
SIMEAS P Parameterization Package 7KG7050-8A Product Information	E50417-X8974-C169
SIMEAS P Application Description PROFIBUS DP	E50417-B1076-C238
SIMEAS P Application Description Modbus	E50417-B1076-C241

IEC 60870-5-103 specification

The IEC 60870-5-103 specification with a detailed explanation of the IEC 60870-5-103 protocol is contained in the

- International Standard
IEC 60870-5-103
Telecontrol equipment and systems
Transmission protocols -
Companion standard for the informative
interface of protection systems

Target audience

This manual is directed to the user of the Power Meter SIMEAS P.

Standard

The development of the equipment was executed after the guidelines of the ISO 9000.

Validity of the manual

This manual is valid for:
SIMEAS P50 devices with firmware version V04 (V04.00 or higher).

Additional Support

In case of problems or questions please contact your Siemens representative or our Customer Support Center.

Phone: +49 - 180 - 524 7000
Fax: +49 - 180 - 524 2471
E-mail: support.energy@siemens.com
FAQ www.siemens.com/energy-support/faq-en

Further information under:

www.powerquality.de/pq_da/index_e.htm

Training courses

Please ask our Training Center for information on the individual courses available:

Siemens AG
Power Transmission and Distribution
Power Training Center
Humboldtstr. 59
90459 Nuremberg
Germany
Phone: +49 911 433-7005
Fax: +49 911 433-7929
Internet: www.ptd-training.com

Information for your safety

This manual does not represent a complete listing of all the safety measures required to operate the equipment (module, device) since specific operating conditions may make further measures necessary. However, it contains information which you have to observe in order to ensure your personal safety and in order to avoid material damage. The information is highlighted by a warning triangle and, depending on the degree of danger, is shown as follows:



Danger

indicates that death, severe personal injury or substantial material damage **will** result if appropriate precautions are not taken.



Warning

indicates that death, severe personal injury or substantial material damage **may** result if appropriate precautions are not taken.



Caution

indicates that minor bodily injury or material damage may result if appropriate precautions are not taken.



Important

indicates that material damage may result if appropriate precautions are not taken.



Note

indicates important information about the device, its handling or the respective part of the instruction manual to which attention should be drawn.



Qualified personnel

Commissioning and operation of the equipment (module, device) described in this manual may only be carried out by qualified personnel. Qualified personnel in the sense of the safety instructions in this manual are persons who are entitled to commission, enable, earth and identify devices, systems and circuits in accordance with the standards of safety technology.

Use as prescribed

The equipment (device, module) may only be used for the applications described in the catalogue and the technical specifications and only in combination with third party equipment recommended or approved by Siemens.

The successful and safe operation of this device is dependent on proper handling, storage, installation, operation, and maintenance.

Hazardous voltages are present in parts of this electrical equipment during operation. Severe personal injury or material damage may result if the device is not handled properly.

- The device is to be earthed to the protective-earth terminal before any other connections are made.
- Hazardous voltages may occur in all the circuit parts connected to the power supply.
- Hazardous voltages may be present in the equipment even after the power supply has been removed (capacitors may still be charged).
- Equipment with current transformer circuits must not be operated openly.

The limit values specified in the manual or in the operating instructions must not be exceeded; this must also be observed during testing and commissioning.

Indication of conformity

	<p>This product complies with the directive of the Council of the European Communities on the approximation of the laws of the member states relating to electromagnetic compatibility (EMC Council Directive 2004/108/EC) and concerning electrical equipment for use within specified voltage limits (Low Voltage Directive 2006/95/EC).</p> <p>This conformity has been proved by tests performed according to the Council Directives in agreement with the generic standards EN 61000-6-2 and EN 61000-6-4 (for EMC Directive) and with the standard EN 61010-1 (for Low Voltage Directive) by Siemens AG.</p> <p>This device was designed and produced for industrial use according to the standard EN 61000-6-4.</p> <p>The product conforms to the standards IEC 60688, EN 60688 or DIN EN 60688.</p>
---	--

Revision Index

Listing of the changes between the editions of this manual:

Modified chapters / pages	Edition	Reasons of modification
	V01.00	First edition, Doc.-No.: E50417-B1076-C375-A1 2006-12-05
2.1, 2.2, 3.1 to 3.3 and Glossary	V01.10.02	Second edition, Doc.-No.: E50417-B1076-C375-A2 2008-04-02
2.2 and 3.1	V01.11.01	3rd edition, Doc.-No.: E50417-B1076-C375-A3 2009-01-02

Table of Contents

	Foreword	3
	Revision Index	7
1	Firmware Versions.....	11
1.1	Firmware Versions Overview.....	12
1.2	Updating from V03 to V04	14
2	Parameters and Properties	15
2.1	Bus Specific Parameters	16
2.1.1	General.....	16
2.1.2	IEC 60870-5-103 Settings	17
2.2	Functional Range	19
2.2.1	Basic Application Functions.....	19
2.2.2	Standard ASDUs in Monitoring Direction	20
2.2.3	Standard ASDUs in Control Direction.....	21
3	Data Mapping	23
3.1	Measured Quantities	24
3.1.1	Mapping.....	24
3.1.1.1	Measured Values Mapping.....	24
3.1.1.2	Explanations to the "100 % corresponds to" Value	26
3.1.2	Measured Value Telegrams	28
3.1.2.1	Compatible Measurands II.....	29
3.1.2.2	Private Measurands 1-phase Additional.....	29
3.1.2.3	Private Measurands 3-phase, First Additional.....	30
3.1.2.4	Private Measurands 3-phase, Second Additional.....	30
3.1.2.5	Private Measurands 1-phase Additional (with Harmonics).....	31
3.1.2.6	Private Measurands 3-phase, First Additional (with Harmonics).....	32
3.1.2.7	Private Measurands, Analog Inputs.....	33
3.1.2.8	Private Measurands, Analog Outputs (only transmitted, if an Analog Output module is available)	33
3.1.2.9	Transmitted Telegrams vs. Network Type and I/O Module Assembly	34
3.1.2.10	Write of Parameter for Analog Output Module	35
3.2	Commands and Events	36

3.3	Counters	38
3.3.1	ASDU.....	38
3.3.2	Mapping.....	39
3.3.2.1	Energy Counters from Binary Inputs.....	39
3.3.2.2	Energy Counters Calculated from Measurement Values.....	39
4	Technical Data.....	41
4.1	Functional Range.....	42
4.2	Hardware Interface	43
	Glossary.....	45
	Index.....	47

Firmware Versions

This chapter describes the SIMEAS P50 firmware prerequisites for using the IEC 60870-5-103 protocol and implication of updating the firmware to version V04.

1.1	Firmware Versions Overview	12
1.2	Updating from V03 to V04	14

1.1 Firmware Versions Overview

Firmware versions Two firmware versions V03 and V04 are available for the SIMEAS P50 device which

- offer identical basic functionality,
- differ in the supported communication protocols (refer to Table 1-1),
- can be loaded alternatively in the SIMEAS P50. ¹⁾

Communication protocols Table 1-1 shows which communication protocols are supported by the SIMEAS P50 firmware versions:

Firmware version	Communication protocol		
	PROFIBUS DP	Modbus	IEC 60870-5-103
V03	yes ¹⁾	yes	no
V04	no	yes	yes

Table 1-1 Communication protocols vs. SIMEAS P50 firmware versions



Note:

For using the **IEC 60870-5-103** protocol a SIMEAS P50 device with firmware V04 is necessary

The use of the **IEC 60870-5-103** communication protocol and configuration software “SIMEAS P Parameterization” up to V01.30 is limited to SIMEAS P50 devices with integrated display (7KG7750) because of additional communication parameters (refer to chapter 1.2).

¹⁾ PROFIBUS DP isn't available at devices SIMEAS P with the order no. 7KG7750-0xA0x-0AA1.

Identification of the firmware version

The current firmware version of your SIMEAS P50 can be identified as follows:

- Read the device identification using the software “SIMEAS P Parameterization” as described as preparation for a firmware update in the Application Description “Firmware Update” (refer to page 3 for the order number of this document), e.g.:

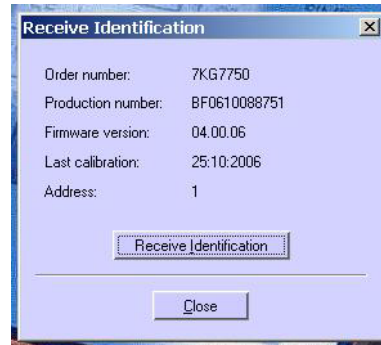

- Devices with integrated display (7KG7750):
 - the firmware version is shown at the display after device start-up for 15 seconds, e.g.:

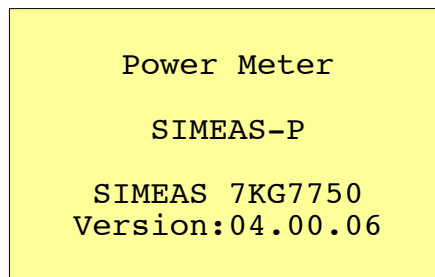

- the menu “>settings” - “>about SIMEAS” can be selected which shows basic device data, e.g.:

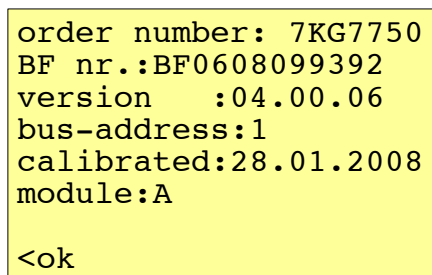

1.2 Updating from V03 to V04

Firmware	<p>For using the IEC 60870-5-103 protocol a SIMEAS P50 device with firmware V04 is necessary (refer to Table 1-1).</p> <p>If your SIMEAS P50 has firmware V03 loaded then an update to firmware V04 has to be executed.</p> <p>Please refer to the Application description “Firmware Update” (refer to page 3 for the order number of this document) for a step-by-step description of the firmware update process.</p>
Parameter set	<p>An existing SIMEAS P50 parameter set used with firmware V03 can be used furthermore with firmware V04.</p> <p>The additional parameter MV range will be added automatically but must be set to the required value during configuration of the IEC 60870-5-103 bus parameters (refer to chapter 2.1).</p>
SIMEAS P Parameterization V01.30	<p>The version V01.30 of the software “SIMEAS P Parameterization” does not support the IEC 60870-5-103 protocol configuration.</p> <p>This has the following implications with SIMEAS P50 V04:</p> <ul style="list-style-type: none">• If in “SIMEAS P Parameterization” the protocol Profibus DP is selected (which is not supported in SIMEAS P50 firmware version V04) then in the device the protocol IEC 60870-5-103 is set instead.• The new parameter MV range can not be changed using “SIMEAS P Parameterization”. <p>Therefore, the use of the IEC 60870-5-103 communication protocol and configuration software “SIMEAS P Parameterization” up to V01.30 is limited to SIMEAS P50 devices with integrated display (7KG7750).</p>
SIMEAS P Parameterization V01.40	<p>Supports IEC 60870-5-103 communication protocol and configuration software „SIMEAS P Parameterization“ V01.40.</p>

Parameters and Properties

This chapter describes the properties and functions of the IEC 60870-5-103 slave of the SIMEAS P50 and the bus specific parameters which have to be selected during parameterization.

2.1	Bus Specific Parameters	16
2.2	Functional Range	19

2.1 Bus Specific Parameters

2.1.1 General

The following settings for the serial communication between the IEC 60870-5-103 master and the IEC 60870-5-103 slave have to be defined during parameterization of the SIMEAS P50 device.



Note:

The use of the IEC 60870-5-103 communication protocol and configuration software “SIMEAS P Parameterization” up to V01.30 is limited to SIMEAS P50 devices with integrated display (7KG7750) because of additional communication parameters (refer to chapter 1.2).

For parameterization of the bus specific parameters in SIMEAS P PAR from V1.40 please open the dialog box *Device connection parameters* (Fig. 2-1) using the menu command:

Menu Device → Connection configuration → Edit.

Adjust the parameters in the dialog box *Device connection parameters* (Fig. 2-1):

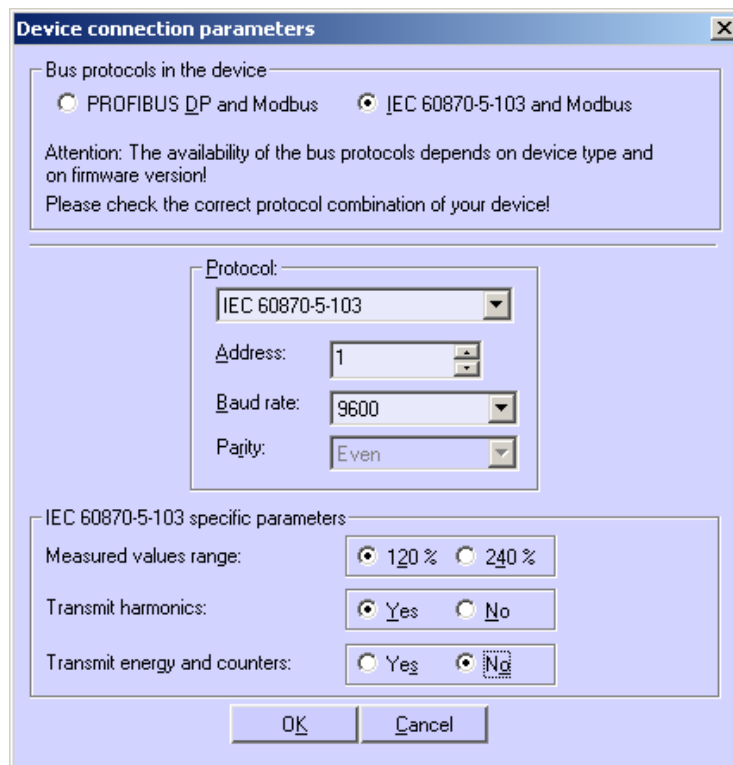

Fig. 2-1 Dialog box Device connection parameters, from SIMEAS P PAR version 1.40



Note:

See Manual SIMEAS P 7KG7750/55 Device Manual, order no. E50417-B1076-C340, for further information.

At devices with integrated display the following bus specific parameters can be set by selection of the menu ">settings" - ">basic settings" - ">interface", e.g.:

```
*bus address:112
*baudrate:   19200Bd
*parity:     E
*protocol:   IEC 103
>IEC 103 settings

<ok
<cancel
```

Note:

The screen is valid from firmware version 4.10.

Fig. 2-2 Screen ">interface"

After selection of "> IEC 103 settings" the screen shown in Fig. 2-2 appears. Here you can set the "MV range.." as well as transmission of "Harmonics.." and "Counters...".

```
*MV range:   240%
*Harmonics:  no
*Counters:   no

<ok
<cancel
```

Note:

The screen is valid from firmware version 4.10.

Fig. 2-3 Sub-screen "IEC 103 settings" from Fig. 2-2

2.1.2 IEC 60870-5-103 Settings

Bus address Permissible bus addresses are in the range between 1 and 254.

Baud rate The following values for transmission speed are supported:

- 9600 bit/s,
- 19200 bit/s and
- 38400 bit/s.



Note:

During the baud rate selection for IEC 60870-5-103 via "SIMEAS P Parameterization" or via display the complete range from 300 bit/s to 115200 bit/s is offered. But only 9600 bit/s to 38400 bit/s are permitted for IEC 60870-5-103.

Parity Parity is adjustable to none, even or odd parity bit (N, E, O). The predefined parity acc. to IEC 60870-5-103 specification is: E (even).

Protocol	“IEC 103” selects the IEC 60870-5-103 protocol.
IEC 103 settings	Open the screen acc. to Fig. 2-3 (from Version 4.10) with MV range, Harmonics and Counters.
MV range	<p>An additional IEC 60870-5-103 parameter determines the end range of the transmitted measured values via the protocol.</p> <p>All measured values are transferred via IEC 60870-5-103 as per-unit values in two octets which contain the measured values itself as 12 bits and an overflow as well as an error indication bit.</p> <p>The additional parameter now decides if the measured value ranges of -4096 to +4095 correspond either</p> <ul style="list-style-type: none">• from -120 % to +120 % or• from -240 % to + 240 % <p>of the nominal values.</p>



Note:

The screen IEC 103 settings also is offered if Modbus is selected as protocol, but then does not have any effect.

Harmonics	<p>The transmission of harmonic is adjustable (yes or no), from version 4.10. See chapters 3.1.2.5 and 3.1.2.6.</p> <ul style="list-style-type: none">• yes: telegram function type 130, Information number 153 (1-phase) or 154 (3-phase) is transmitted• no: no transmission
Counters	<p>The transmission of counters is adjustable (yes or no), from version 4.10. See chapter 3.3.2.</p> <ul style="list-style-type: none">• yes: counters acc. to table 3-6 are transmitted• no: not transmission

2.2 Functional Range

This chapter describes the functional range which is supported by the IEC 60870-5-103 slave interface of the SIMEAS P50 device.

2.2.1 Basic Application Functions

IEC 60870-5-103 function	Supported by SIMEAS P50?	Remark
Station Initialization	yes	Station initialization is necessary: <ul style="list-style-type: none"> • After device start-up (power-up or reset) or • After no telegram was received by the device for the period of five minutes which is addressed to this slave or is a broadcast telegram.
General Interrogation	yes	Refer to table 3-4 for a list of events which are contained in general interrogation.
Clock Synchronization	yes	Using the individual IEC 60870-5-103 device address or the broadcast address.
Command Transmission	yes	Commands to additional modules (binary output, relay output) and to onboard binary output.
Test Mode	no	SIMEAS P50 can not switch to Test Mode. The function is not applicable.
Blocking of Monitoring Direction	no	As in the case of Test Mode, this is a function which is not supported by the SIMEAS P50.
Transmission of Disturbance Data	no	-
Generic Services	yes	Used for write of parameter (Analog Output module).

Table 2-1 Basic application functions

Clock synchronization

The accuracy of the internal clock of the SIMEAS P50 with clock synchronization via IEC 60870-5-103 compared to the clock of the IEC 60870-5-103 master is ± 100 ms.

The SIMEAS P50 automatically calculates based on the start and end dates configured for the parameter **Clock Change** if the current date is summertime (daylight saving time) or not.

Therefore, the SU bit in the Time Synchronization message in control direction is ignored by the SIMEAS P50 device.

The SU bit in the Time Synchronization message in monitoring direction is set according to the internal summertime recognition of the current date.

2.2.2 Standard ASDUs in Monitoring Direction

#	Designation	Supported by SIMEAS P50?	Remark
ASDU 1	Time-tagged message	yes	All available events and binary information with time stamp. Also the information from modules in additional module slot.
ASDU 2	Time-tagged message with relative time	no	-
ASDU 3	Measurands I	no	-
ASDU 4	Time-tagged measurands with relative time	no	-
ASDU 5	Identification	yes	Function type: 130 Manufacturer (eight ASCII characters): „SIEMENS“ SW identification (four ASCII characters): e.g. „0400“ = Version V04.00
ASDU 6	Time synchronization	yes	-
ASDU 8	General interrogation termination	yes	-
ASDU 9	Measurands II	yes	refer to chapter 3.1.2, “Measured Value Telegrams”
ASDU 10	Generic data	yes	see chapter 3.1.2.10
ASDU 11	Generic identification	no	-
ASDU 23	List of disturbance data	no	-
ASDU 26	Ready for transmission of disturbance data	no	-
ASDU 27	Ready for transmission of channel	no	-
ASDU 28	Ready for transmission of tags	no	-
ASDU 29	Transmission of tags	no	-
ASDU 30	Transmission of disturbance values	no	-
ASDU 31	End of transmission	no	-

Table 2-2 Standard ASDUs in monitoring direction

2.2.3 Standard ASDUs in Control Direction

#	Designation	Supported by SIMEAS P50?	Remark
ASDU 6	Time synchronization	yes	-
ASDU 7	General interrogation	yes	-
ASDU 10	Generic data	yes	see chapter 3.1.2.10
ASDU 20	General command	yes	Command to additional modules (binary output, relay output) and to onboard binary outputs.
ASDU 21	Generic command	no	-
ASDU 24	Order for disturbance data transmission	no	-
ASDU 25	ACK for disturbance data transmission	no	-

Table 2-3 Standard ASDUs in control direction

Data Mapping

This chapter describes the data mapping of the IEC 60870-5-103 slave of the SIMEAS P50 devices.

3.1	Measured Quantities	24
3.2	Commands and Events	36
3.3	Counters	38

3.1 Measured Quantities

3.1.1 Mapping

3.1.1.1 Measured Values Mapping

The SIMEAS P50 device supports transmission of measured values via the communication protocol IEC 60870-5-103.

All measured values are transferred as per-unit values.

The column "100 % corresponds to" in the table below shows the relation between the 100 % per-unit value and the corresponding measured value. Additional explanations are given below the table.

Please also refer to chapter 2.1.2 for the selection of the measured value ranges via protocol.

#	Value	Measured quantity	100 % corresponds to	Function type	Information number	Compatibility	Data unit	Position
1	Van	Voltage (A-N)	$V_{L-N (nom.)}$	130	148	yes	9	4
2	Vbn	Voltage (B-N)	$V_{L-N (nom.)}$	130	148	yes	9	5
3	Vcn	Voltage (C-N)	$V_{L-N (nom.)}$	130	148	yes	9	6
4	Vab	Voltage (A-B)	$V_{L-L (nom.)}$	130	151	no	9	1
5	Vbc	Voltage (B-C)	$V_{L-L (nom.)}$	130	151	no	9	2
6	Vca	Voltage (C-A)	$V_{L-L (nom.)}$	130	151	no	9	3
7	V	Average Voltage	$V_{L-N (nom.)}$	130	151	no	9	4
8	Ia	Current (A)	$I_{(nom.)}$	130	148	yes	9	1
9	Ib	Current (B)	$I_{(nom.)}$	130	148	yes	9	2
10	Ic	Current (C)	$I_{(nom.)}$	130	148	yes	9	3
11	I	Average Current	$I_{(nom.)}$	130	151	no	9	9
12	3I0	Neutral Current	$I_{(nom.)}$	130	151	no	9	10
13	Pa	Real Power (A)	$I_{(nom.)} * V_{L-N (nom.)}$	130	150	no	9	1
14	Pb	Real Power (B)	$I_{(nom.)} * V_{L-N (nom.)}$	130	152	no	9	1
15	Pc	Real Power (C)	$I_{(nom.)} * V_{L-N (nom.)}$	130	152	no	9	2
16	P	Real Power	$3 * I_{(nom.)} * V_{L-N (nom.)}$	130	148	yes	9	7
17	Qa	Reactive Power (A)	$I_{(nom.)} * V_{L-N (nom.)}$	130	150	no	9	2

#	Value	Measured quantity	100 % corresponds to	Function type	Information number	Compatibility	Data unit	Position
18	Qb	Reactive Power (B)	$I_{(nom.)} * V_{L-N (nom.)}$	130	152	no	9	3
19	Qc	Reactive Power (C)	$I_{(nom.)} * V_{L-N (nom.)}$	130	152	no	9	4
20	Q	Reactive Power	$3 * I_{(nom.)} * V_{L-N (nom.)}$	130	148	yes	9	8
21	Sa	Apparent Power (A)	$I_{(nom.)} * V_{L-N (nom.)}$	130	150	no	9	3
22	Sb	Apparent Power (B)	$I_{(nom.)} * V_{L-N (nom.)}$	130	152	no	9	5
23	Sc	Apparent Power (C)	$I_{(nom.)} * V_{L-N (nom.)}$	130	152	no	9	6
24	S	Apparent Power	$3 * I_{(nom.)} * V_{L-N (nom.)}$	130	151	no	9	5
25	cos ϕ (a)	cos ϕ (A)	1	130	150	no	9	4
26	cos ϕ (b)	cos ϕ (B)	1	130	152	no	9	7
27	cos ϕ (c)	cos ϕ (C)	1	130	152	no	9	8
28	cos ϕ	cos ϕ	1	130	151	no	9	6
29	PFa	Power Factor (A)	1	130	150	no	9	5
30	PFb	Power Factor (B)	1	130	152	no	9	9
31	PFc	Power Factor (C)	1	130	152	no	9	10
32	PF	Power Factor	1	130	151	no	9	7
33	PHIa	Phase Angle (A)	180°	130	150	no	9	6
34	PHIb	Phase Angle (B)	180°	130	152	no	9	11
35	PHIc	Phase Angle (C)	180°	130	152	no	9	12
36	PHI	Phase Angle	180°	130	151	no	9	8
37	Freq	System Frequency	5 Hz deviation	130	148	yes	9	9
38	ASymV	Asymmetrical Voltage	100 %	130	152	no	9	13
39	ASymI	Asymmetrical Current	100 %	130	152	no	9	14
40	THD Van	THD Voltage (A-N)	100 %	130	150	no	9	7
41	THD Vbn	THD Voltage (B-N)	100 %	130	152	no	9	15
42	THD Vcn	THD Voltage (C-N)	100 %	130	152	no	9	16
43	THD Ia	THD Current (A)	100 %	130	150	no	9	8
44	THD Ib	THD Current (B)	100 %	130	152	no	9	17
45	THD Ic	THD Current (C)	100 %	130	152	no	9	18

#	Value	Measured quantity	100 % corresponds to	Function type	Information number	Compatibility	Data unit	Position
46*)	HVan 3,5,7,11,13,17,19	Harmonic Voltage (A-N)	100 %	130	153	no	9	1 to 7
47*)	HVbn 3,5,7,11,13,17,19	Harmonic Voltage (B-N)	100 %	130	154	no	9	1 to 7
48*)	HVcn 3,5,7,11,13,17,19	Harmonic Voltage (C-N)	100 %	130	154	no	9	8 to 14
49*)	Hla 3,5,7,11,13,17,19	Harmonic Current (A)	100 %	130	153	no	9	8 to 14
50*)	Hlb 3,5,7,11,13,17,19	Harmonic Current (B)	100 %	130	154	no	9	15 to 21
51*)	Hlc 3,5,7,11,13,17,19	Harmonic Current (C)	100 %	130	154	no	9	22 to 28
52*)	AI_A12	Analog input 1 at AI module in slot A (terminals A1-A2)	20 mA	130	155	no	9	1
53*)	AI_A34	Analog input 2 at AI module in slot A (terminals A3-A4)	20 mA	130	155	no	9	2
54**)	AO_Channel1	Analog output 1	20 mA	130	156	no	9	1
55**)	AO_Channel2	Analog output 2	20 mA	130	156	no	9	2

Table 3-1 Mapping table *) supported from version 4.10 **) supported from version 4.20

3.1.1.2 Explanations to the "100 % corresponds to" Value

For selected measured values from Table 3-1 an explanation of the value in the "100 % corresponds to" column is given here:

Voltages and currents

All 100 % values correspond to the associated selected nominal operating values (AC 1 A or AC 5 A for currents and AC 110 V, AC 190 V, AC 400 V or AC 690 V for voltages V_{L-L}).



Note:

In the dialog box **Basic settings - Connections / Transformer** of the SIMEAS P Parameterization software not the nominal values but the measurement ranges (which correspond to 120 % of the nominal values) are selected (refer to Figure 3-1).

Selected V_{L-L} Measurement Range	100 % V_{L-L} =	100 % V_{L-N} =
AC 132 V	AC 110 V	AC 64 V
AC 228 V	AC 190 V	AC 110 V
AC 480 V	AC 400 V	AC 230 V
AC 828 V	AC 690 V	AC 400 V

Table 3-2 Voltage measurement ranges vs. 100 % values

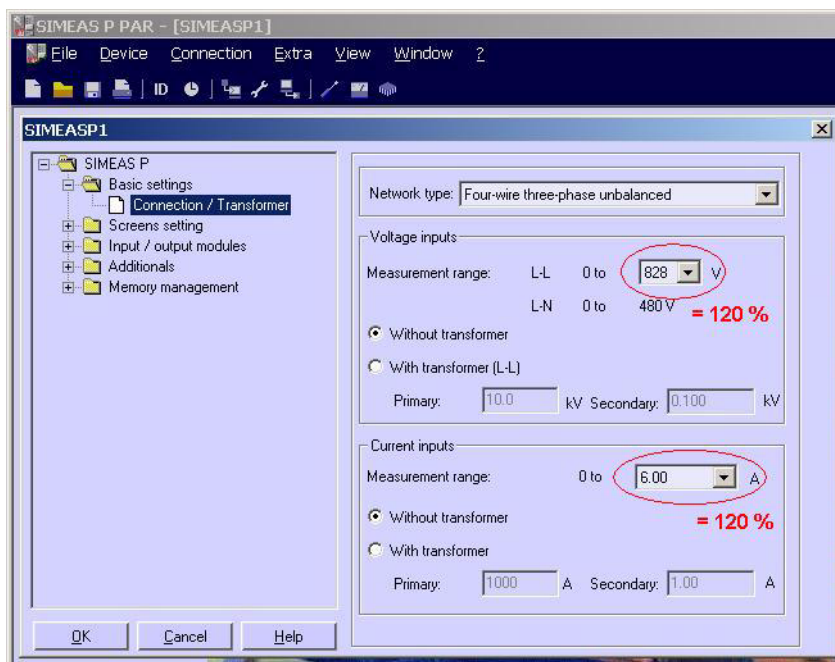

Figure 3-1 Basic settings - Connection/Transformer Frequency

The SIMEAS P50 automatically recognizes the line frequency (either 50 Hz or 60 Hz) and can measure it with an accuracy of 10 mHz in the measurement range of 45 Hz to 65 Hz.

Via IEC 60870-5-103 the deviation of the line frequency is transmitted. A deviation of 5 Hz corresponds to 100 %.

Examples for 50 Hz nominal frequency:

- Line frequency = 50 Hz → IEC 60870-5-103 value = 0 %
- Line frequency = 54 Hz → IEC 60870-5-103 value = 80 %
- Line frequency = 49 Hz → IEC 60870-5-103 value = -20 %

Examples for 60 Hz nominal frequency:

- Line frequency = 60 Hz → IEC 60870-5-103 value = 0 %
- Line frequency = 64 Hz → IEC 60870-5-103 value = 80 %
- Line frequency = 59 Hz → IEC 60870-5-103 value = -20 %



Note:

If Van is less than 30 % of its nominal value then the frequency is indicated as invalid in the IEC 60870-5-103 telegram.

cos ϕ

The Power Factor $\cos \phi$ is shown at the device display with

- a sign which indicates demand or supply power and
- an inductive or capacitive marking.

Example for inductive load and delivered power:

cos ϕ -1.000 ind

In the $\cos\phi$ values which are transmitted via IEC 60870-5-103 only the capacitive/ inductive information is contained using the sign of the value:

- negative $\cos \phi$: capacitive
- positive $\cos \phi$: inductive.

For the above shown example, the positive 100 % value is transmitted.

3.1.2 Measured Value Telegrams

The measured values of the SIMEAS P50 device are transmitted via IEC 60870-5-103 using seven different telegrams.

Depending on the selected **Network type** (ref. to Figure 3-1), the parameters to the transmission of the harmonics (see chapter 2.1.2) and the assembled I/O modules either all or only a selected number of these telegrams are sent to the IEC 60870-5-103 master on request of class 2 data.

Please refer to chapter 3.1.2.9 for more information about the relation of the selected **parameters** and the transmitted telegrams.



Note (valid for version 4.10 and higher):

In the case of overflow:

- the overflow flag is set,
 - the measured value is set to its maximum positive or maximum negative value respectively.
-

The measurands telegrams are defined as follows (see next sections):

3.1.2.1 Compatible Measurands II

Data Unit = 9
Identifier (max. 9 elements)
Cause of Transmission (COT)
Address of ASDU
Function Type = 130
Information Number = 148
Current (A)
Current (B)
Current (C)
Voltage (A-N)
Voltage (B-N)
Voltage (C-N)
Real Power
Reactive Power
System Frequency

3.1.2.2 Private Measurands 1-phase Additional

Data Unit = 9
Identifier (max. 8 elements)
Cause of Transmission (COT)
Address of ASDU
Function Type = 130
Information Number = 150
Real Power (A)
Reactive Power (A)
Apparent Power (A)
$\cos\phi$ (A)
Power Factor (A)
Phase Angle (A)
THD Voltage (A-N)
THD Current (A)

3.1.2.3 Private Measurands 3-phase, First Additional

Data Unit = 9
Identifier (max. 10 elements)
Cause of Transmission (COT)
Address of ASDU
Function Type = 130
Information Number = 151
Voltage (A-B)
Voltage (B-C)
Voltage (C-A)
Average Voltage
Apparent Power
cos ϕ
Power Factor
Phase Angle
Average Current
Neutral Current

3.1.2.4 Private Measurands 3-phase, Second Additional

Data Unit = 9
Identifier (max. 18 elements)
Cause of Transmission (COT)
Address of ASDU
Function Type = 130
Information Number = 152
Real Power (B)
Real Power (C)
Reactive Power (B)
Reactive Power (C)
Apparent Power (B)
Apparent Power (C)
cos ϕ (B)
cos ϕ (C)
Power Factor (B)
Power Factor (C)

Phase Angle (B)
Phase Angle (C)
Asymmetrical Voltage
Asymmetrical Current
THD Voltage (B-N)
THD Voltage (C-N)
THD Current (B)
THD Current (C)

3.1.2.5 Private Measurands 1-phase Additional (with Harmonics)

Data Unit = 9
Identifier (max. 14 elements)
Cause of Transmission (COT)
Address of ASDU
Function Type = 130
Information Number = 153
Harmonic Voltage 3 (A-N)
Harmonic Voltage 5 (A-N)
Harmonic Voltage 7 (A-N)
Harmonic Voltage 11 (A-N)
Harmonic Voltage 13 (A-N)
Harmonic Voltage 17 (A-N)
Harmonic Voltage 19 (A-N)
Harmonic Current 3 (A-N)
Harmonic Current 5 (A-N)
Harmonic Current 7 (A-N)
Harmonic Current 11 (A-N)
Harmonic Current 13 (A-N)
Harmonic Current 17 (A-N)
Harmonic Current 19 (A-N)

3.1.2.6 Private Measurands 3-phase, First Additional (with Harmonics)

Data Unit = 9
Identifier (max. 28 elements)
Cause of Transmission (COT)
Address of ASDU
Function Type = 130
Information Number = 154
Harmonic Voltage 3 (B-N)
Harmonic Voltage 5 (B-N)
Harmonic Voltage 7 (B-N)
Harmonic Voltage 11 (B-N)
Harmonic Voltage 13 (B-N)
Harmonic Voltage 17 (B-N)
Harmonic Voltage 19 (B-N)
Harmonic Voltage 3 (C-N)
Harmonic Voltage 5 (C-N)
Harmonic Voltage 7 (C-N)
Harmonic Voltage 11 (C-N)
Harmonic Voltage 13 (C-N)
Harmonic Voltage 17 (C-N)
Harmonic Voltage 19 (C-N)
Harmonic Current 3 (B-N)
Harmonic Current 5 (B-N)
Harmonic Current 7 (B-N)
Harmonic Current 11 (B-N)
Harmonic Current 13 (B-N)
Harmonic Current 17 (B-N)
Harmonic Current 19 (B-N)
Harmonic Current 3 (C-N)
Harmonic Current 5 (C-N)
Harmonic Current 7 (C-N)
Harmonic Current 11 (C-N)
Harmonic Current 13 (C-N)
Harmonic Current 17 (C-N)
Harmonic Current 19 (C-N)

3.1.2.7 Private Measurands, Analog Inputs

Data Unit = 9
Identifier (max. 2 elements)
Cause of Transmission (COT)
Address of ASDU
Function Type = 130
Information Number = 155
Analog Input 1
Analog Input 2

3.1.2.8 Private Measurands, Analog Outputs (only transmitted, if an Analog Output module is available)

Data Unit = 9
Identifier (max. 2 elements)
Cause of Transmission (COT)
Address of ASDU
Function Type = 130
Information Number = 156
Analog Output Channel 1
Analog Output Channel 2



Note:

Analog Output Channel 1 and Analog Output Channel 2: 0 % = 0 mA; 100 % = 20 mA

3.1.2.9 Transmitted Telegrams vs. Network Type and I/O Module Assembly

Depending on the selected **Network type** (ref. to Figure 3-1), the parameters to the transmission of the harmonics (see chapter 2.1.2) and the assembled I/O modules either all or only a selected number of the above described telegrams are sent to the IEC 60870-5-103 master on request of class 2 data.

For an association of the measured quantities to the selected **Network type** please refer to Table 3-1 in the SIMEAS P50 Device Manual (refer to page 3 for the order number of this document).

	Network Type					
	Single-phase network	Three-wire tree-phase balanced	Three-wire three-phase unbalanced 3I	Three-wire three-phase unbalanced 2I	Four-wire three-phase balanced	Four-wire three-phase unbalanced
Compatible Measurands II	X ¹	X	X	X	X	X
Private Measurands 1-phase additional	X	-	-	-	-	X
Private Measurands 3-phase, first additional	-	X	X	X	X	X
Private Measurands 3-phase, second additional	-	-	-	-	-	X
Private Measurands 1-phase additional (with harmonics if parameter)	X	X	X	X	X	X
Private Measurands 3-phase, first additional (with harmonics if parameter)	-	-	X	X	-	X
Private Measurands Analog Inputs	X	X	X	X	X	X
Private Measurands Analog Outputs	X	X	X	X	X	X

1 The values for 3N as well as for phases L₂ and L₃ in the Compatible Measurands telegram which are not available for this Network type are indicated as invalid.

Table 3-3 Transmitted telegrams vs. Network type and I/O module assembly

The telegrams are transferred sequentially, i.e. every time the IEC 60870-5-103 master requests class 2 data, the IEC 60870-5-103 slave sends the next following telegram in the order shown in Table 3-3.

When the last additional measurands telegram was sent, it starts with "Compatible Measurands II" again.

The IEC 60870-5-103 master can request

- only one telegram or
- a part of the telegrams or
- all telegrams

supported according to the **Network type** from one device and then change to the next device.

3.1.2.10 Write of Parameter for Analog Output Module

There is the possibility of changing parameters over the protocol IEC 60870-5-103. This is carried out with the help of the generic data. The lists of the changeable parameter is contained in the mapping description for the respective device.

Write the value of a single entry

This function requests the device to accept new values of a single entry referenced by its Generic Identification Number (GIN). The assignment of the GIN to the parameter is contained in the mapping description for the respective device.

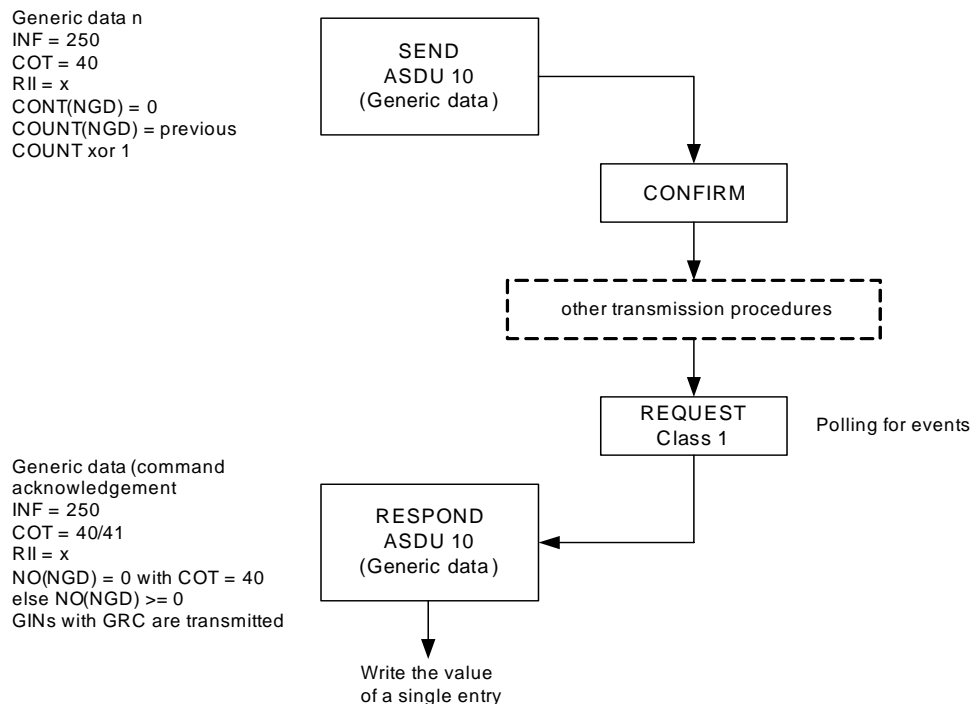

Figure 3-2 Write the value of a single entry

No.	Designation	Description	Type of Information	GIN	KOD ¹	GDD	NGD
1	AO1	Analog Output 1	AO1	0x0101	1	4- INT	1
2	AO2	Analog Output 2	AO2	0x0102	1	4- INT	1

1 actual value

GIN: Generic Identification Number

KOD: Kind of Description

GDD: Generic Data Description

NGD: Number of Generic Data Set

3.2 Commands and Events

The following table contains all available commands and events as well as the information of the modules:

#	Designation	Description	Type of Information	Function Type	Information Number	Compatibility	Data Unit	General Interrogation
1	BO1	Binary Output 1 (Terminal G3)	Event	131	32	no	1	yes
2	BO1 (onboard binary output)	Binary Output 1 (Terminal G3)	Command	131	32	no	20	-
3	BO2	Binary Output 2 (Terminal G2)	Event	131	33	no	1	yes
4	BO2 (onboard binary output)	Binary Output 2 (Terminal G2)	Command	131	33	no	20	-
5	RO_A1	Relay Output 1 at RO module in Slot A (Terminal A1)	Event	131	34	no	1	yes
6	RO_A1	Relay Output 1 at RO module in Slot A (Terminal A1)	Command	131	34	no	20	-
7	RO_A2	Relay Output 2 at RO module in Slot A (Terminal A2)	Event	131	35	no	1	yes
8	RO_A2	Relay Output 2 at RO module in Slot A (Terminal A2)	Command	131	35	no	20	-
9	RO_A3	Relay Output 3 at RO module in Slot A (Terminal A3)	Event	131	36	no	1	yes
10	RO_A3	Relay Output 3 at RO module in Slot A (Terminal A3)	Command	131	36	no	20	-
11	BO_A1	Binary Output 1 at BO module in Slot A (Terminal A2)	Event	131	37	no	1	yes
12	BO_A1	Binary Output 1 at BO module in Slot A (Terminal A2)	Command	131	37	no	20	-
13	BO_A2	Binary Output 2 at BO module in Slot A (Terminal A3)	Event	131	38	no	1	yes
14	BO_A2	Binary Output 2 at BO module in Slot A (Terminal A3)	Command	131	38	no	20	-

#	Designation	Description	Type of Information	Function Type	Information Number	Compatibility	Data Unit	General Interrogation
15	BI_A12	Binary Input 1 at BI module in Slot A (Terminals A1-A2)	Event	131	41	no	1	yes
16	BI_A34	Binary Input 2 at BI module in Slot A (Terminals A3-A4)	Event	131	42	no	1	yes
17	LM1	Limit value 1	Event	131	49	no	1	yes
18	LM2	Limit value 2	Event	131	50	no	1	yes
19	LM3	Limit value 3	Event	131	51	no	1	yes
20	LM4	Limit value 4	Event	131	52	no	1	yes
21	LM5	Limit value 5	Event	131	53	no	1	yes
22	LM6	Limit value 6	Event	131	54	no	1	yes
23	LM7	Limit value 7	Event	131	55	no	1	yes
24	BF	Battery fault	Event	131	56	no	1	yes
25	RST_Energy	Reset energy	Event	131	58	no	1	no
26	RST_MinMax	Reset min/max values	Event	131	59	no	1	no
27	RST_Counter	Reset counter	Event	131	60	no	1	no
28	RST_Power	Reset power values	Event	131	61	no	1	no
29	RST_Mean	Reset mean values	Event	131	62	no	1	no
30	RST_Alarm	Reset alarm log	Event	131	63	no	1	no
31	RST_Binary	Reset binary log	Event	131	64	no	1	no
32	RST_Osc	Reset oscilloscope	Event	131	65	no	1	no

Table 3-4 Commands and Events

3.3 Counters

Metering values (e.g. kWh) are not defined in the IEC standard and there are no compatible data units available which are suitable for the transmission of metered values. The private data unit 205 has been defined for the transmission of metered values using Class 1 data format.

Only one metering value per data unit is transmitted. There exists a cyclic interval for transmitting the counters which is set fixed to 1 min in SIMEAS P50.

3.3.1 ASDU

The structure of the Application Service Data Unit 205 (ASDU 205) is defined as follows:

Structure element	Comment	Bytes
Type identification	205	1
Variable structure qualifier	0x81	1
Cause of transmission	0x01	1
Device address	ADDR	1
Function type	FUN	1
Information number	INF	1
Counter	see definition below	4
Time	ms	2
	min	1
	hours	1

Counter definition (4 Byte):

	Bit 8	Bit 7	Bit 6	Bit 5	Bit 4	Bit 3	Bit 2	Bit 1
Byte 1	2^7 > Metered value <							2^0
Byte 2	2^{15} > Metered value <							2^8
Byte 3	2^{23} > Metered value <							2^{16}
Byte 4	2^{31}	Irrelevant	2^{29}	2^{28} : Sign	2^{27}	Metered value		2^{24}

Table 3-5 Application Service Data Unit (ASDU)

3.3.2 Mapping

#	Value	Comment	Function Type	Information Number	Compatibility	Data Unit
1	Energy counter 1	from binary input	133	55	no	205
2	Energy counter 2		133	56	no	205
3	Active energy demand	from calculated measurement values	133	51	no	205
4	Active energy supply		133	53	no	205
5	Reactive energy inductive		133	52	no	205
6	Reactive energy capacitive		133	54	no	205

Table 3-6 Mapping table

With the parameter "IEC 103 Settings - Counters" (see chapter 3.3.1) the user can select, whether the energy values (table 3-6) will be transferred.

3.3.2.1 Energy Counters from Binary Inputs

Energy Counter 1 and Energy Counter 2 count energy pulses from binary inputs via binary input module.

For conversion of the transmitted pulses to an energy value, a factor "Energy increase per pulse" has to be defined during parameterization of the binary input (ref. to the SIMEAS P 7KG7750/55 Device Manual).

3.3.2.2 Energy Counters Calculated from Measurement Values

The required conversion factor for the calculation is 1837.

The following formula applies to the calculation of the energy:

Formula

$$\text{Energy} = \frac{U_{\text{nom}} \times I_{\text{nom}} \times 1 \text{ h} \times \text{Energycounter}}{1837}$$

U_{nom} : Voltage measuring range L-N x Transformation ratio of the voltage transformer

I_{nom} : Current measuring range x Transformation ratio of the current transformer

1 h: 1 hour

1837: Conversion factor

Example

Measured values:

current energy counter = 3000; $U_{\text{nom(L-N)}} = 10 \text{ kV}$; $I_{\text{nom}} = 100 \text{ A}$

Calculation:

$$\Xi_{\text{energy}} = \frac{10 \text{ kV} \times 100 \text{ A} \times 1 \text{ h} \times 3000}{1837} = 1633 \text{ kWh}$$

Technical Data

4

This chapter gives a summary about the technical data of the IEC 60870-5-103 slave of the SIMEAS P50 devices including the bus interface.

4.1	Functional Range	42
4.2	Hardware Interface	43

4.1 Functional Range

IEC 60870-5-103 Slave	Bus addresses	1 to 254
	IEC 60870-5-103 functions	Identification Time synchronization General interrogation Measurands II Time-tagged messages General Commands
	Measurands range	120 %, 240 %
Data transmission	Baud rates	9600 bit/s, 19200 bit/s, 38400 bit/s
	Parity bit	EVEN (NONE, ODD)

4.2 Hardware Interface

Bus connection 9-pole D-SUB outlet

Pin	Signal	Meaning
1	Shield	Shield / Operational ground
2	-	-
3	A	RS485 connection pin A
4	RTS	Directions control
5	GND _{EXT}	Data transmission level (ground towards +5 V _{EXT})
6	+5 V _{EXT}	Supply voltage for terminating resistors (DC +5 V, max. 100 mA)
7	-	-
8	B	RS485 connection pin B
9	-	-

Table 4-1 Pin assignment of the bus connector (D-SUB outlet)

Protocol	semi-duplex
Max. line length	1000 m / 3300 ft.
Insulation level	AC 500 V
Bus termination	Bus termination via bus plug with integrated terminating resistors.

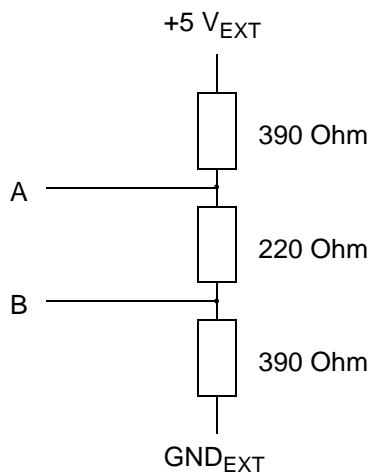

Figure 4-1 Recommended external termination circuit with open-line fail-safe

Level	Transmitter: <ul style="list-style-type: none">• Low: $-5\text{ V} \leq V_{A-B} \leq -1,5\text{ V}$• High: $+5\text{ V} \geq V_{A-B} \geq +1,5\text{ V}$ Receiver: <ul style="list-style-type: none">• Low: $V_{A-B} \leq -0,2\text{ V}$• High: $V_{A-B} \geq +0,2\text{ V}$ Transmitter and receiver are surge-proof for voltages between A and GND_{EXT} as well as between B and GND_{EXT} in the range of -7 V to $+12\text{ V}$.
Max. number of modules at the bus	32 (according to the RS485 standard) If more than 32 devices are needed, RS485 repeaters which support bit retiming have to be used.

Glossary

ADDR	Device Address
AI	Analog Input
AO	Analog Output
ASCII	American Standard Code for Information Interchange
ASDU	Application Service Data Unit
BI	Binary Input
BO	Binary Output
COT	Cause of Transmission
FUN	Function Type
GDD	Generic Data Description
GID	Generic Identification Number
IEC	International Electrotechnical Commission
INF	Information Number
KOD	Kind of Description
MV	Measured Value
NGD	Number of Generic Data Set
RO	Relay Output
THD	Total Harmonic Distortion

Index

B

- Baud rate 17
- Bus address 17
- Bus connection 43
- Bus specific parameters 16
- Bus termination 43

D

- Data mapping 23

F

- Firmware update 14
- Firmware version
 - Identification 13
 - Overview 12

I

- IEC 60870-5-103
 - Basic application functions 19
 - Clock Synchronization 19
 - General Interrogation 19
 - Identification 20
 - Measurands II 20, 28
 - Standard ASDUs
 - Control direction 21
 - Monitoring direction 20
 - Station Initialization 19

L

- Line length 43

M

- Mapping table 24
- Measured value telegrams
 - Compatible Measurands II 29
 - Private Measurands
 - 1-phase additional 29
 - 3-phase, first additional 30
 - 3-phase, second additional 30
 - Telegrams vs. Network type 34

- MV range 18

P

- Parity 17

T

- Technical data 41
- Transmission speed 17

V

- Validity of the manual 4

