





CYLINDER LOCK KEY NUMBER 2



Model	
Product brand name	SETRON
Product designation	Accessories

Certificates				
General Product Approval	EMC	Declaration of Conformity	Test Certificates	other
 VDE		 RCM	 EG-Konf.	Type Test Certificates/Test Report Miscellaneous

Further information
Information- and Downloadcenter (Catalogs, Brochures,...) http://www.siemens.com/lowvoltage/catalogs
Industry Mall (Online ordering system) https://mall.industry.siemens.com/mall/en/en/Catalog/product?mfb=3VA9980-0VL20
Service&Support (Manuals, Certificates, Characteristics, FAQs,...) https://support.industry.siemens.com/cs/ww/en/ps/3VA9980-0VL20
Image database (product images, 2D dimension drawings, 3D models, device circuit diagrams, ...) http://www.automation.siemens.com/bilddb/cax_en.aspx?mfb=3VA9980-0VL20

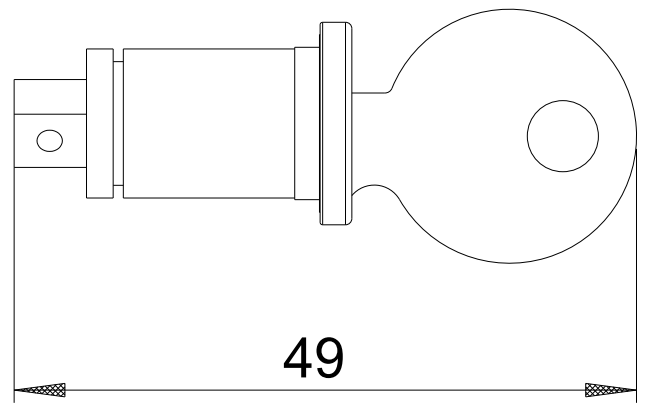
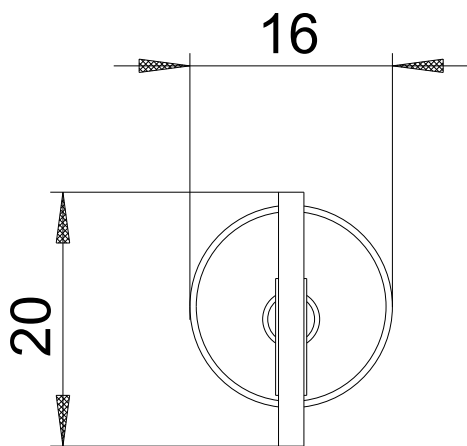

last modified:

11/09/2017