





REAR CONNECTION STUD FLAT SHORT 1 PCS. ACCESSORY  
FOR: 3VA6 400/600



Model	
Product brand name	SETRON
Product designation	accessories

Certificates			
General Product Approval	EMC	Declaration of Conformity	other
 CSA	 UL		 RCM
			 EG-Konf.
			<a href="#">Miscellaneous</a>

Further information
<b>Information- and Downloadcenter (Catalogs, Brochures,...)</b> <a href="http://www.siemens.com/lowvoltage/catalogs">http://www.siemens.com/lowvoltage/catalogs</a>
<b>Industry Mall (Online ordering system)</b> <a href="https://mall.industry.siemens.com/mall/en/en/Catalog/product?mfb=3VA9471-0QE10">https://mall.industry.siemens.com/mall/en/en/Catalog/product?mfb=3VA9471-0QE10</a>
<b>Service&amp;Support (Manuals, Certificates, Characteristics, FAQs,...)</b> <a href="https://support.industry.siemens.com/cs/ww/en/ps/3VA9471-0QE10">https://support.industry.siemens.com/cs/ww/en/ps/3VA9471-0QE10</a>
<b>Image database (product images, 2D dimension drawings, 3D models, device circuit diagrams, ...)</b> <a href="http://www.automation.siemens.com/bilddb/cax_en.aspx?mfb=3VA9471-0QE10">http://www.automation.siemens.com/bilddb/cax_en.aspx?mfb=3VA9471-0QE10</a>

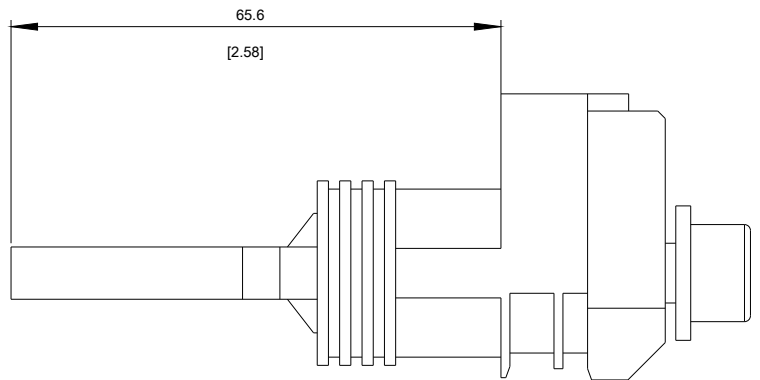
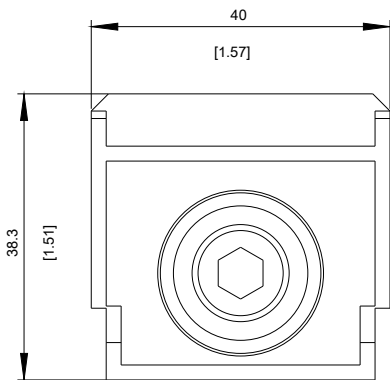

**last modified:**

11/20/2017