





Front rotary operating mechanism emergency stop IEC IP30/40
 Accessory for: 3VA6 150/250 3VA5 250



Model	
Product brand name	SENTRON
Product designation	Accessories
Design of the product	Front rotary operating mechanism
accessories	FRONT ROTARY OPERATING MECHANISM
General technical data	
Degree of protection NEMA rating	NEMA 1
Mechanical Design	
Height	82 mm
Width	105 mm
Depth	102 mm
Certificates	

General Product Approval	EMC	Declaration of Conformity	other
 CSA  UL  EAC	 RCM	 EG-Konf.	Miscellaneous

Further information

Information- and Downloadcenter (Catalogs, Brochures,...)

<http://www.siemens.com/lowvoltage/catalogs>

Industry Mall (Online ordering system)

<https://mall.industry.siemens.com/mall/en/en/Catalog/product?mlfb=3VA9277-0EK15>

Service&Support (Manuals, Certificates, Characteristics, FAQs,...)

<https://support.industry.siemens.com/cs/ww/en/ps/3VA9277-0EK15>

Image database (product images, 2D dimension drawings, 3D models, device circuit diagrams, ...)

http://www.automation.siemens.com/bilddb/cax_en.aspx?mlfb=3VA9277-0EK15

CAX-Online-Generator

<http://www.siemens.com/cax>

Tender specifications

<http://www.siemens.com/specifications>

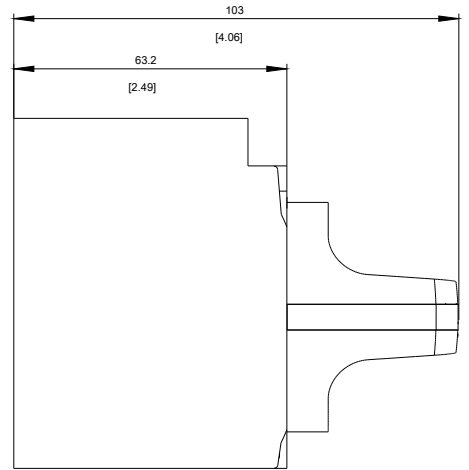
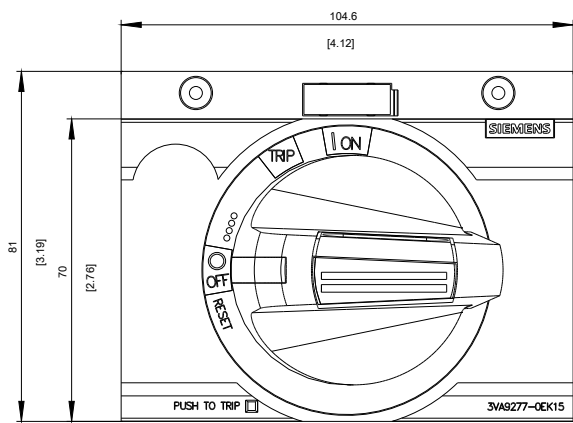

last modified:

12/05/2017