

PLUG-IN UNIT CONVERSION KIT FOR MCCB ACCESSORY FOR:
CIRCUIT BREAKER, 3 POLE 3VA6 150/250

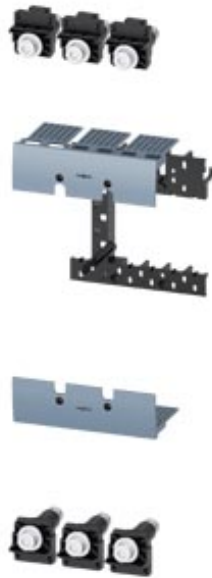

Model	
Product brand name	SENTRON
Product designation	Accessories
Design of the product	Plug-in unit
accessories	Plug-in unit

Certificates

General Product Approval	EMC	Declaration of Conformity	other
--------------------------	-----	---------------------------	-------



[Miscellaneous](#)

Further information

Information- and Downloadcenter (Catalogs, Brochures,...)

<http://www.siemens.com/lowvoltage/catalogs>

Industry Mall (Online ordering system)

<https://mall.industry.siemens.com/mall/en/en/Catalog/product?mfb=3VA9143-0KP10>

Service&Support (Manuals, Certificates, Characteristics, FAQs,...)

<https://support.industry.siemens.com/cs/ww/en/ps/3VA9143-0KP10>

Image database (product images, 2D dimension drawings, 3D models, device circuit diagrams, ...)

http://www.automation.siemens.com/bilddb/cax_en.aspx?mlfb=3VA9143-0KP10

CAX-Online-Generator

<http://www.siemens.com/cax>

Tender specifications

<http://www.siemens.com/specifications>

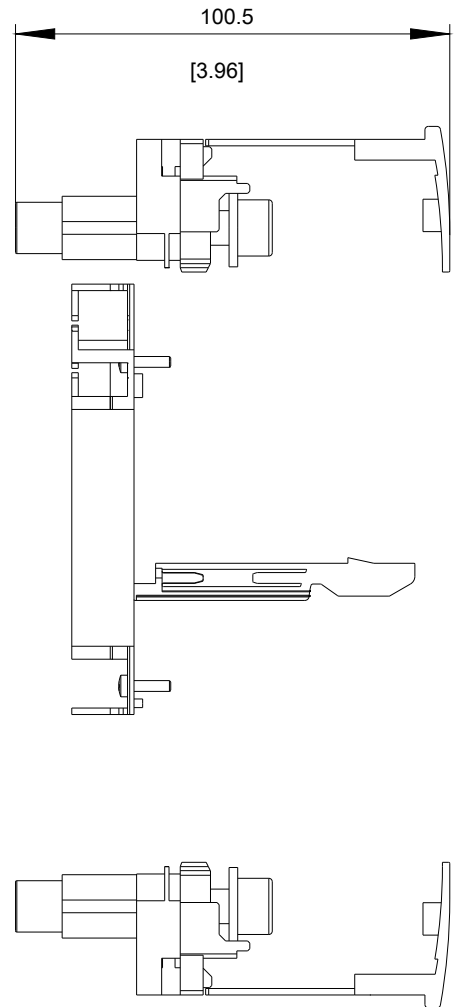
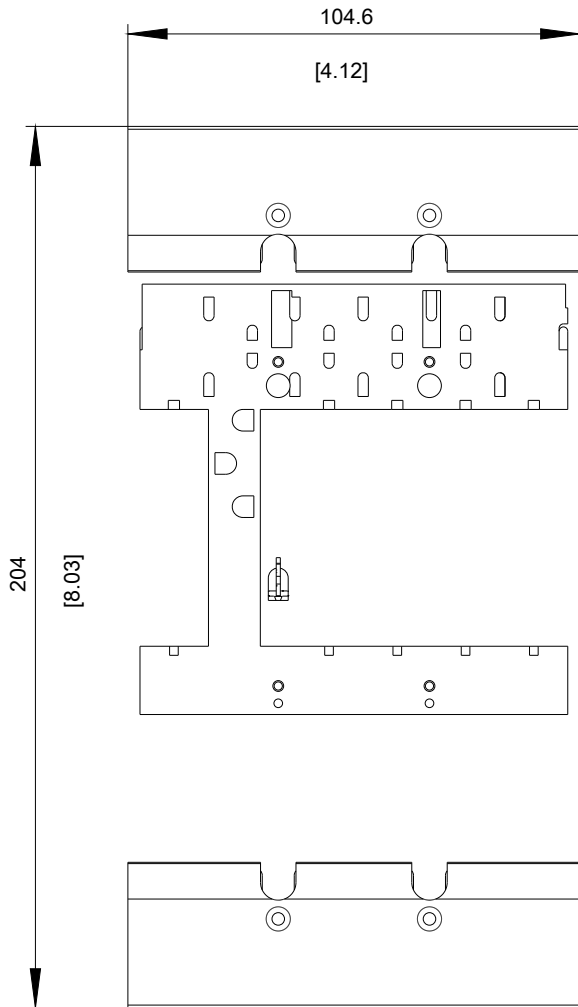

last modified:

11/17/2017