





SIDE MOUNTED ROTARY OPERATOR EMERGENCY-STOP IEC  
IP65 WITH MOUNTING PLATE ILLUMINATION KIT 24 V DC  
ACCESSORY FOR: 3VA5 125



Model	
Product brand name	SETRON
Product designation	Accessories
Design of the product	Side wall-mounted rotary operator
accessories	SIDE WALL-MOUNTED ROTARY OPERATOR

General technical data	
Degree of protection NEMA rating	NEMA 1, 3R, 12

Mechanical Design	
Height	70 mm

Certificates			
General Product Approval	EMC	Declaration of Conformity	other
			 <a href="#">Miscellaneous</a>



[Miscellaneous](#)

## Further information

### Information- and Downloadcenter (Catalogs, Brochures,...)

<http://www.siemens.com/lowvoltage/catalogs>

### Industry Mall (Online ordering system)

<https://mall.industry.siemens.com/mall/en/en/Catalog/product?mlfb=3VA9137-0PK57>

### Service&Support (Manuals, Certificates, Characteristics, FAQs,...)

<https://support.industry.siemens.com/cs/ww/en/ps/3VA9137-0PK57>

### Image database (product images, 2D dimension drawings, 3D models, device circuit diagrams, ...)

[http://www.automation.siemens.com/bilddb/cax\\_en.aspx?mlfb=3VA9137-0PK57](http://www.automation.siemens.com/bilddb/cax_en.aspx?mlfb=3VA9137-0PK57)

### CAX-Online-Generator

<http://www.siemens.com/cax>

### Tender specifications

<http://www.siemens.com/specifications>

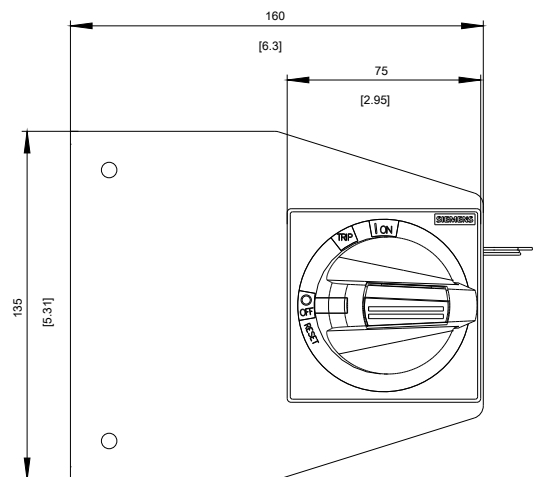
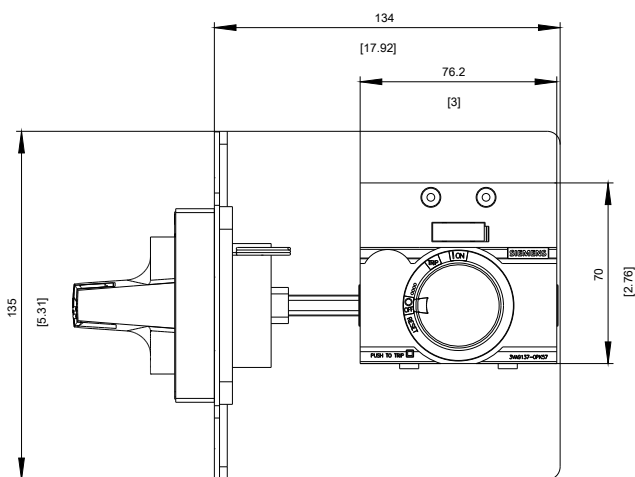

**last modified:**

11/17/2017