





ADAPTER CYLINDER LOCK ACCESSORY POCKET ACCESSORY
FOR: 3VA5 125



Model	
Product brand name	SETRON
Product designation	Accessories

Certificates			
General Product Approval	EMC	Declaration of Conformity	other
 CSA	 UL		 RCM
		 EG-Konf.	Miscellaneous

Further information
Information- and Downloadcenter (Catalogs, Brochures,...) http://www.siemens.com/lowvoltage/catalogs
Industry Mall (Online ordering system) https://mall.industry.siemens.com/mall/en/en/Catalog/product?mfb=3VA9137-0LF10
Service&Support (Manuals, Certificates, Characteristics, FAQs,...) https://support.industry.siemens.com/cs/ww/en/ps/3VA9137-0LF10
Image database (product images, 2D dimension drawings, 3D models, device circuit diagrams, ...) http://www.automation.siemens.com/bilddb/cax_en.aspx?mfb=3VA9137-0LF10

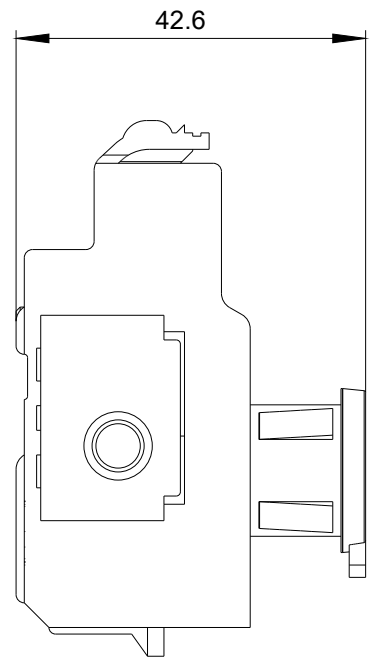
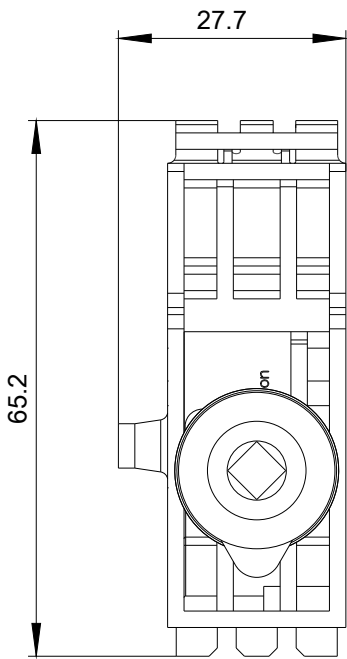

last modified:

11/21/2017