



CIRCUIT BREAKER 3VA6 UL FRAME 600 BREAKING CAPACITY CLASS M 35KA @ 480V 3-POLE, LINE PROTECTION ETU860, LSIG, IN=400A OVERLOAD PROTECTION IR=160A ...400A SHORT CIRCUIT PROTECTION ISD=0,6..10X IN, II=1,5..12X IN NEUTRAL PROTECTION OPTIONAL WITH EXT. CT,UPTO 160% GROUND-FAULT-PROTECTION IG=0,2... 1 X IN, TG=0,05-0,8S W/O CONNECTION

Model	
Product brand name	SENTRON
Product designation	Molded-case circuit breaker
Design of the product	System protection
Design of the load switch / acc. to UL 489 / Heating, Air Conditioning, and Refrigeration circuit breaker (HACR Type)	Yes
Design of the overcurrent release	ETU860
Protective function of the overcurrent release	LSIG
Number of poles	3
General technical data	
Tension assignée d'isolement U_i	600 V
Max. rated operational voltage U_e with AC 50/60Hz	600 V
Active power loss / for rated value of the current / at AC / in hot operating state / per device	70 W
Active power loss / for rated value of the current / at AC / in hot operating state / per pole	23.33 W
Mechanical service life (switching cycles) / typical	15 000

Electrical endurance (switching cycles) / at AC-1 / at 380/415 V 50/60 Hz	4 000
Electrical endurance (switching cycles) / at AC-1 / at 690 V 50/60 Hz	2 500
Electrical endurance (switching cycles) / at 480 V / at 50/60 Hz	4 000
Electrical endurance (switching cycles) / at 600 V / at 50/60 Hz	3 000
Neutral conductors / upgradeable/retrofitable	Yes
Ground fault monitoring version	Summation current formation L-conductor
Product function	
• communication function	Yes
• other measurement function	Yes

Electricity

Marking / acc. to UL 489 / 100%-rated breaker	No
Max. rated operational voltage of the size of the circuit-breaker	600 A
Courant permanent assigné lu	400 A
Operating current	
• at 40 °C	400 A
• at 45 °C	400 A
• at 50 °C	400 A
• at 55 °C	400 A
• at 60 °C	400 A
• at 65 °C	400 A
• at 70 °C	400 A

Switching capacity according to IEC 60947

Switching capacity class of the circuit breaker	M
Maximum short-circuit current breaking capacity (I _{cu})	
• at 240 V	85 kA
• at 415 V	55 kA
• at 690 V	6 kA
Operational short-circuit current breaking capacity (I _{cs})	
• at 240 V	85 kA
• at 415 V	55 kA
• at 690 V	6 kA
Short-circuit current making capacity (I _{cm})	
• at 240 V	187 kA
• at 415 V	121 kA
• at 690 V	9 kA

Switching capacity according to UL 489

Breaking capacity current	
• at 240 V	100 kA
• at 480 Y/277 V	35 kA
• at 480 V	35 kA
• at 600 Y/347 V	18 kA
• at 600 V	18 kA

Adjustable parameters

Adjustable response value current / I _g min.	160 A
Adjustable response value current / I _g min.	400 A
Adjustable response value current / I _g min.	0.5
Adjustable response value current / I _g min.	25
Adjustable response value current / I _g min.	240 A
Adjustable response value current / I _g min.	4 000 A
Adjustable response value current / I _g min.	0.05 s
Adjustable response value current / I _g min.	0.5 s
Adjustable response value current / I _g min.	0.05 s
Adjustable response value current / I _g min.	0.5 s
Adjustable response value current / I _i min.	600 A
Adjustable response value current / I _i max.	4 800 A
Ground fault protection can be switched ON/OFF	Yes
Ground fault protection / tripping switchable / I _{2t} =ON/OFF	Yes
Adjustable response value current / I _g min.	80 A
Adjustable response value current / I _g max.	400 A
Adjustable response value current / t _g min.	0.05 s
Adjustable response value current / I _g min.	0.8 s

Mechanical Design

Height [in]	9.8 in
Height	248 mm
Width [in]	5.4 in
Width	138 mm
Depth [in]	4.3 in
Depth	110 mm

Connections

Arrangement of electrical connectors / for main current circuit	Without connection
Type of electrical connection / for main current circuit	Without

Auxiliary circuit

Number of CO contacts / for auxiliary contacts	0
--	---

Accessories

Product extension / optional / motor drive	Yes
--	-----

Environmental conditions

Protection class IP / on the front	IP40
Ambient temperature	
• during operation / minimum	-25 °C
• during operation / maximum	70 °C
• during storage / minimum	-40 °C
• during storage / maximum	80 °C

Certificates

Equipment marking / acc. to DIN EN 81346-2	Q
Certificate of suitability / as approval for NAVAL (no combat vessels) / Supplement SB	No

General Product Approval

EMC



Declaration of Conformity

Shipping Approval

other



[Miscellaneous](#)

Further information

Information- and Downloadcenter (Catalogs, Brochures,...)

<http://www.siemens.com/lowvoltage/catalogs>

Industry Mall (Online ordering system)

<https://mall.industry.siemens.com/mall/en/en/Catalog/product?mlfb=3VA6440-5KQ31-0AA0>

Service&Support (Manuals, Certificates, Characteristics, FAQs,...)

<https://support.industry.siemens.com/cs/ww/en/ps/3VA6440-5KQ31-0AA0>

Image database (product images, 2D dimension drawings, 3D models, device circuit diagrams, ...)

http://www.automation.siemens.com/bilddb/cax_en.aspx?mlfb=3VA6440-5KQ31-0AA0

CAX-Online-Generator

<http://www.siemens.com/cax>

Tender specifications

<http://www.siemens.com/specifications>

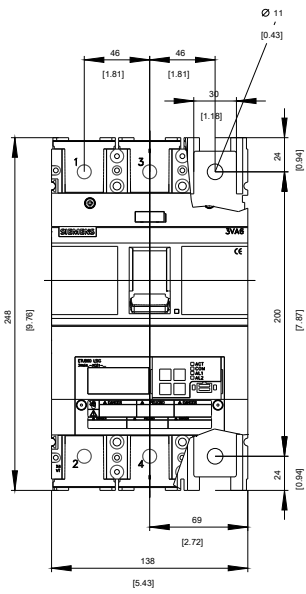

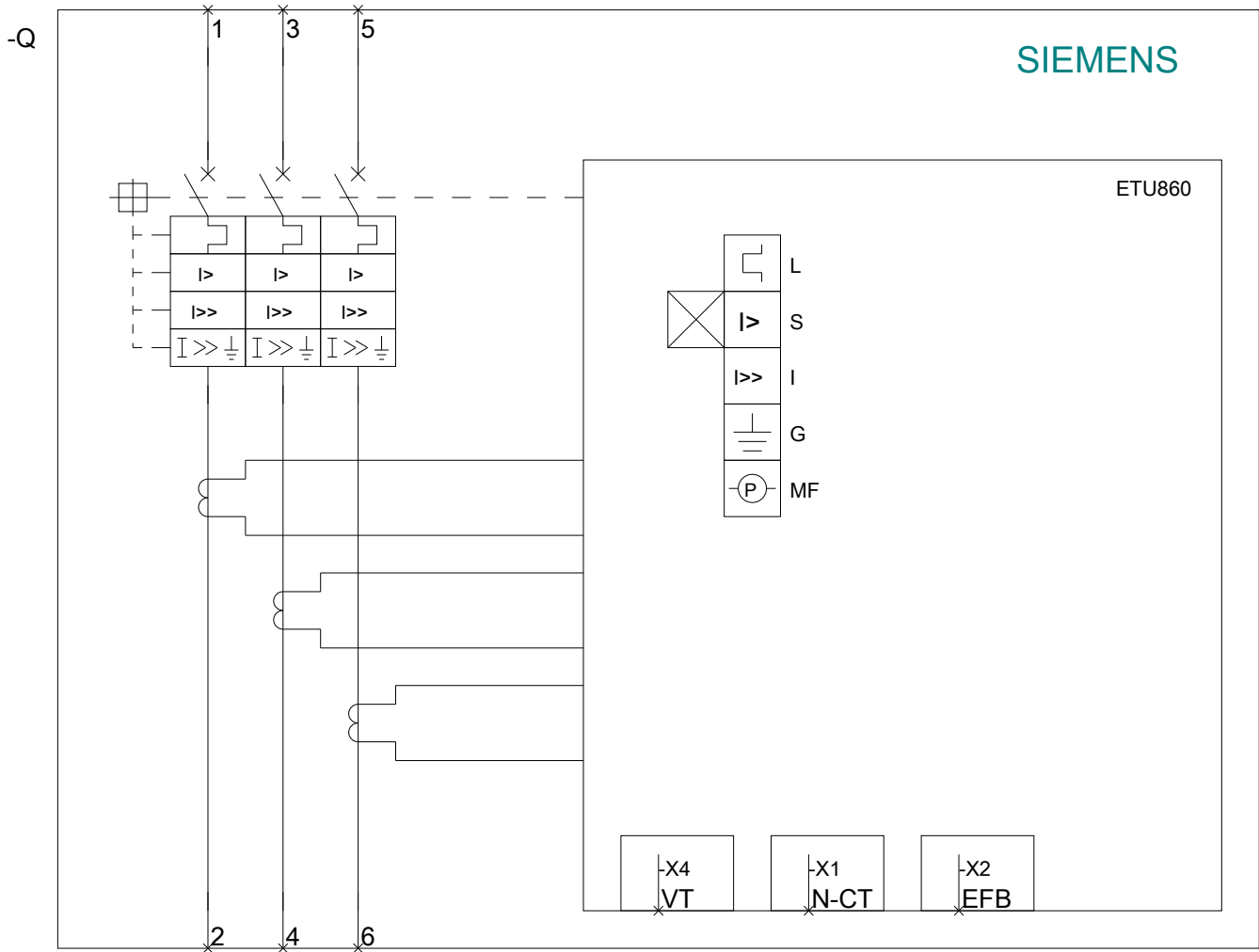



last modified:

11/24/2017