

Koppelglied

Interface Module

Interface

Elemento de acoplamiento

Elemento di accoppiamento

Elemento de acoplamiento

Arayüz modülü

Элемент сопряжения

3TX7002, 3TX7003

3TX7004, 3TX7005



EN 60947, IEC 60947

Betriebsanleitung Instructivo İşletme kılavuzu	Operating Instructions Istruzioni operative Инструкция по эксплуатации	Instructions de service Instruções de Serviço	Bestell-Nr. / Order No.: 3ZX1012-0TX70-2BA1
--	--	--	---

	Deutsch	English	Français	Español
	Vor der Installation, dem Betrieb oder der Wartung des Geräts muss diese Anleitung gelesen und verstanden werden.	Read and understand these instructions before installing, operating, or maintaining the equipment.	Ne pas installer, utiliser ou intervenir sur cet équipement avant d'avoir lu et assimilé ces instructions.	Leer y comprender este instructivo antes de la instalación, operación o mantenimiento del equipo.
	⚠ GEFAHR	⚠ DANGER	⚠ DANGER	⚠ PELIGRO
	Gefährliche Spannung. Lebensgefahr oder schwere Verletzungsgefahr. Vor Beginn der Arbeiten Anlage und Gerät spannungsfrei schalten.	Hazardous voltage. Will cause death or serious injury. Disconnect power before working on equipment.	Tension dangereuse. Danger de mort ou risque de blessures graves. Mettre hors tension avant d'intervenir sur l'appareil.	Tensión peligrosa. Puede causar la muerte o lesiones graves. Desconectar la alimentación eléctrica antes de trabajar en el equipo.
	VORSICHT	CAUTION	PRUDENCE	PRECAUCIÓN
	Eine sichere Gerätefunktion ist nur mit zertifizierten Komponenten gewährleistet.	Reliable functioning of the equipment is only ensured with certified components.	Le fonctionnement sûr de l'appareil n'est garanti qu'avec des composants certifiés.	El funcionamiento seguro del aparato sólo está garantizado con componentes certificados.

	Italiano	Português	Türkçe	Русский
	Leggere con attenzione queste istruzioni prima di installare, utilizzare o eseguire manutenzione su questa apparecchiatura.	Ler e compreender estas instruções antes da instalação, operação ou manutenção do equipamento.	Cihazın kurulumundan, çalıştırılmasından veya bakıma tabi tutulmasından önce, bu kılavuz okunmuş ve anlaşılmış olmalıdır.	Перед установкой, вводом в эксплуатацию или обслуживанием устройства необходимо прочесть и понять данное руководство.
	⚠ PERICOLO	⚠ PERIGO	⚠ TEHLİKE	⚠ ОПАСНО
	Tensione pericolosa. Può provocare morte o lesioni gravi. Scollegare l'alimentazione prima di eseguire interventi sull'apparecchiatura.	Tensão perigosa. Perigo de morte ou ferimentos graves. Desligue a corrente antes de trabalhar no equipamento.	Tehlikeli gerilim. Ölüm tehlikesi veya ağır yaralanma tehlikesi. Çalışmalara başlamadan önce, sistemin ve cihazın gerilim beslemesini kapatınız.	Опасное напряжение. Опасность для жизни или возможность тяжелых травм. Перед началом работ отключить подачу питания к установке и к устройству.
	CAUTELA	CUIDADO	ÖNEMLİ DİKKAT	ОСТОРОЖНО
	Il funzionamento sicuro dell'apparecchiatura è garantito soltanto con componenti certificati.	O funcionamento seguro do aparelho apenas pode ser garantido se forem utilizados os componentes certificados.	Cihazın güvenli çalışması ancak sertifikalı bileşenler kullanılması halinde garanti edilebilir.	Безопасность работы устройства гарантировано только при использовании сертифицированных компонентов.

Technical Assistance: Telephone: +49 (0) 911-895-5900 (8° - 17° CET) Fax: +49 (0) 911-895-5907
 E-mail: technical-assistance@siemens.com
 Internet: www.siemens.de/lowvoltage/technical-assistance

Technical Support: Telephone: +49 (0) 180 50 50 222

3TX7002, 3TX7003

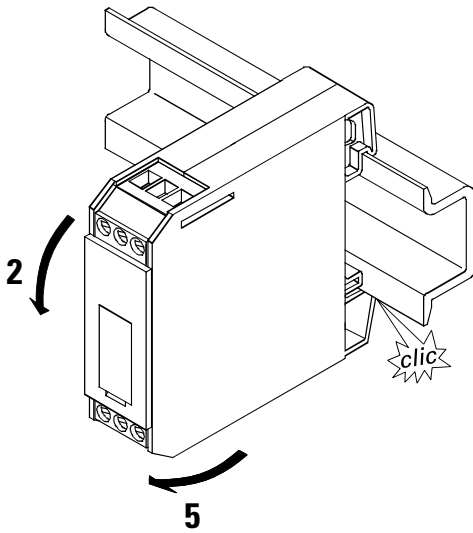

3TX7004, 3TX7005

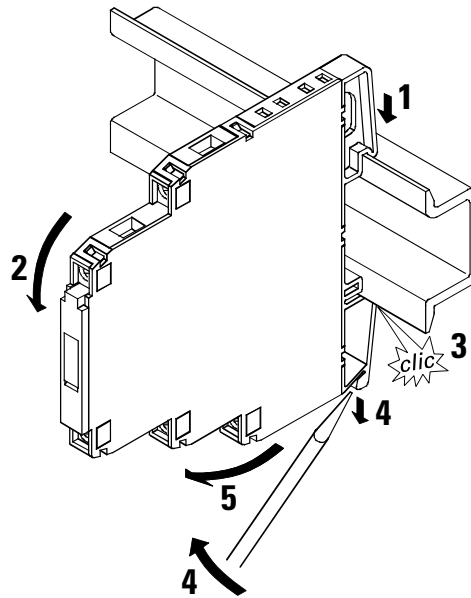

3TX7003, 3TX7005

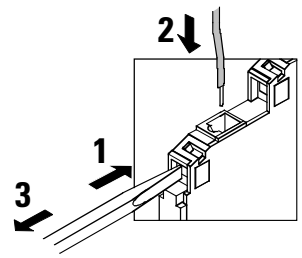

3TX7002, 3TX7003

3TX7 002-.A.00
3TX7 002-1AB02
3TX7 002-2AF05
3TX7 003-.A.00

-1B.00

-1CB00

-1FB02

-2BF02

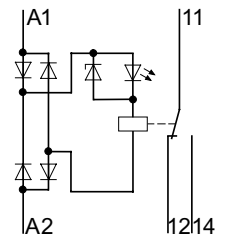
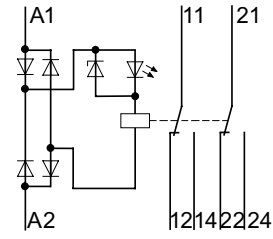
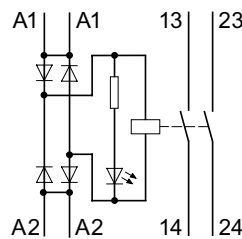
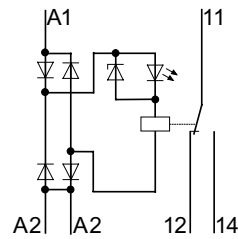
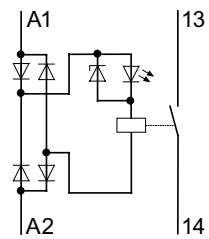

3TX7 002-3AB00

-3AB01

-4AB00

-4AG00

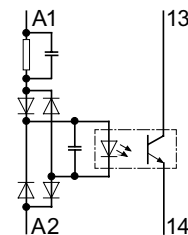
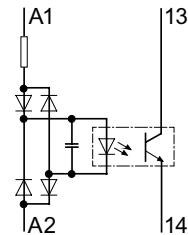
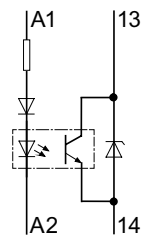
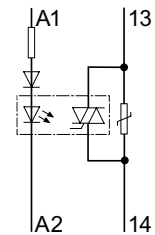

3TX7004, 3TX7005

3TX7 00.-1M.00

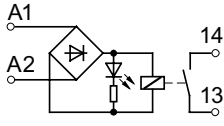

3TX7 00.-1AB10

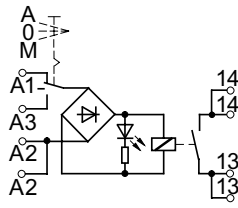

3TX7 00.-1BB00
3TX7 00.-1BF05

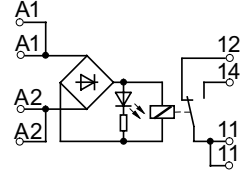

3TX7 00.-1L.0.

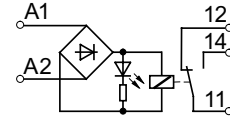

3TX7 00.-1BB10

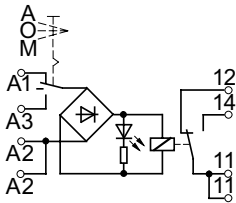

A - Automatik
0 = Nullstellung
M = Manuell

A - Automatic
0 = OFF position
M = Manual

A - automatique
0 = position zéro
M = manuel

A - Automático
0 = Position cero
M = Manual

A - Automatico
0 = Posizione zero
M = Manuale

A - Automático
0 = Posição de repouso
M = Manual

A - Otomatik
0 = Sifir pozisyonu
M = Manüel

A - автоматика
0 = нулевое положение
M = вручную

Eingangskoppelglieder
Input interface modules
Interfaces d'entrée

Elementos de acoplamiento de entrada
Elementi di accoppiamento in ingresso
Elementos de acoplamiento de entrada

Giriş arayüz modülleri
Входные элементы сопряжения

3TX7 00.-2M.02

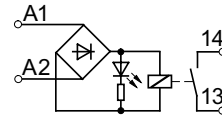

3TX7 00.-3AB04
3TX7 00.-3PB41

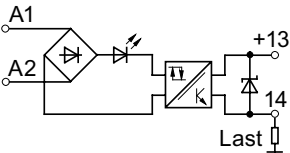

3TX7 00.-3PB54
3TX7 00.-3PG74
3TX7 00.-3PB74

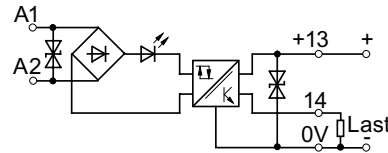

3TX7 00.-3AC04

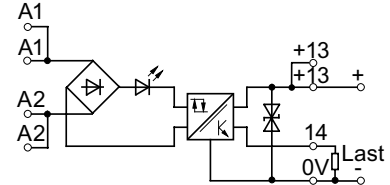

3TX7 00.-3AC14

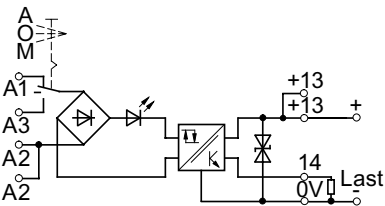

3TX07 00.-3AC03

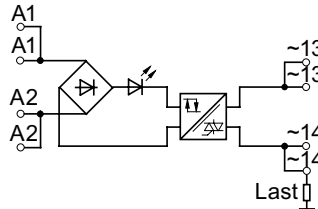

Eingangskoppelglieder
Input interface modules
Interfaces d'entrée
Elementos de acoplamiento de entrada
Elementi di accoppiamento in ingresso
Elementos de acoplamiento de entrada
Giriş arayüz modülleri
Входные элементы сопряжения

3TX7 00.-4PG24

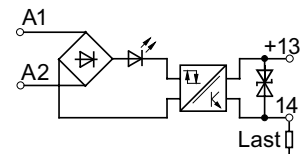

A - Automatik
0 = Nullstellung
M = Manuell

A - Automatic
0 = OFF position
M = Manual

A - automatique
0 = position zéro
M = manuel





A - Automático
0 = Position cero
M = Manual

A - Automatico
0 = Posizione zero
M = Manuale

A - Automático
0 = Posição de repouso
M = Manual

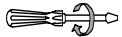
A - Otomatik
0 = Sifir pozisyonu
M = Manüel

A - автоматика
0 = нулевое положение
M = вручную

	3TX7002 3TX7004	3TX7003 3TX7005
	 Ø 3,5 mm	8WA2 804
	0,5 ... 0,8 Nm 4.4 to 7 LB.IN	—
	1 x 0,25 ... 4 mm ² AWG 24 to 12	—
	—	1 x 0,08 ... 2,5 mm ² AWG 28 to 14
	1 x 0,5 ... 2,5 mm ² AWG 20 to 14	—
	—	1 x 0,25 ... 1,5 mm ² AWG 24 to 16

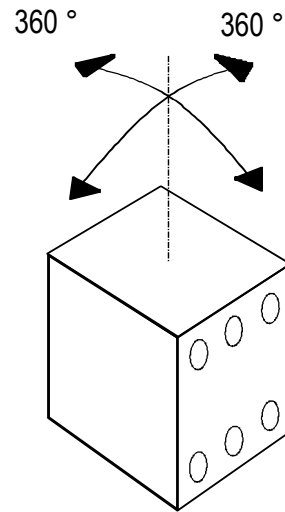

3TX7002, 3TX7003

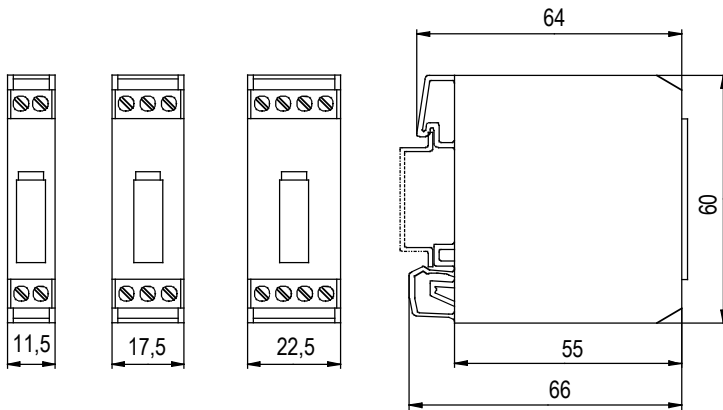

3TX7004, 3TX7005

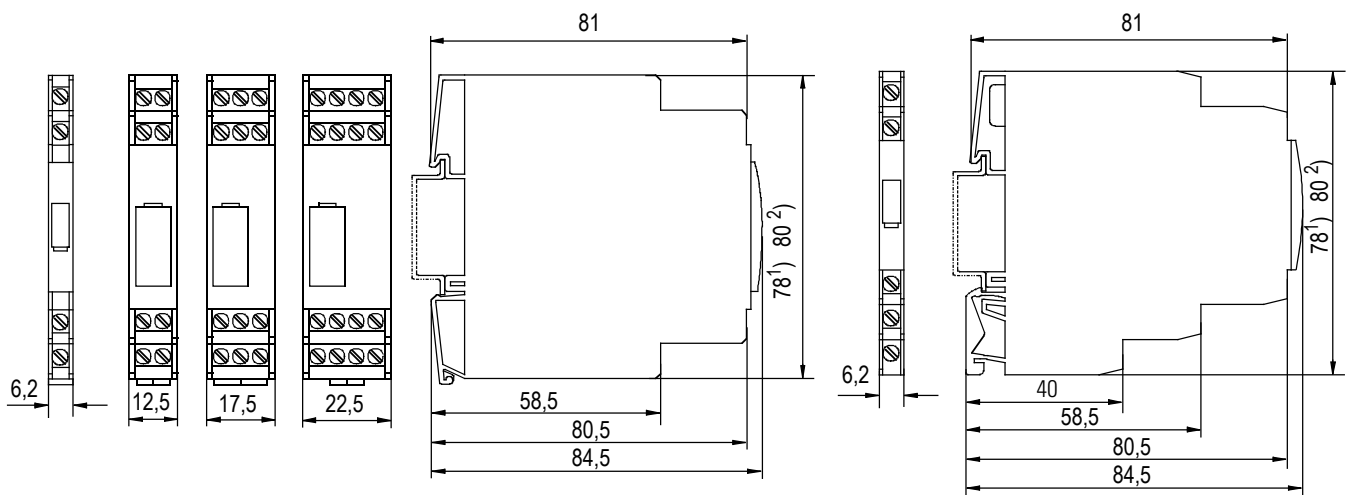

1) 3TX7 004
2) 3TX7 005