

SIEMENS

Indoor/Outdoor Feed-Thru Main Module

Catalog Number

WBT312X350
 WBT312X350U

Enclosure

Type 3R

Module Rating: 1200 Amps, Max.
 Main Vertical Bus Rating: 1200 Amps, Max.
 Main Horizontal Bus Rating: 350 Amps, Max.
 Breaker Rating: 350A Max.
 208Y/120 Volts~, 3 Phase, 4 Wire
 240/120 Volts~, 3 Phase, 4 Wire, Delta (B Phase is High Leg)

CAUTION: The circuit breaker in this enclosure protects the horizontal bus feeding adjacent enclosures. It does not protect the vertical bus or feed through conductors.

For installation by Qualified Person in accordance with all local electrical codes and/or the National Electrical Code®

Circuit breaker trip position is indicated by handle position midway between ON and OFF. To reset, move handle to OFF position, then turn ON.

For overhead or underground feed.

Use 75°C Copper or Aluminum Conductors.

Terminals A, B, C and N: See Lug Chart on adjacent diagram for applicable lug kits, wire size and torque information.

Ground Terminal G
 (Accessory Cat.# ECMLK3225):
 Wire size #4-300 kcmil,
 Torque terminal to 250 lb.-in.

Equip Ground Acc'y Cat. No. ECLX072M

Small Terminals

Wire Range / Torque
 10-14 AWG . . . 20 lb-in
 8 AWG 25 lb-in
 6 AWG 35 lb-in

Large Terminals

Wire Range / Torque
 10-14 AWG . . . 35 lb-in
 8 AWG 40 lb-in
 1/0-6 AWG . . . 45 lb-in

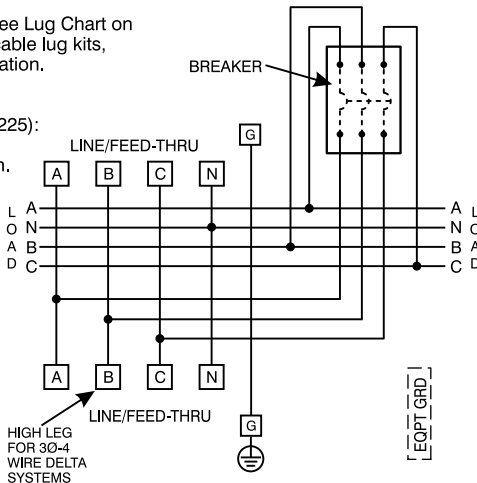

SIEMENS

Connect Modules Using: **Cat. No.** **Torque**
 Quick Connect QC4 400-440 lb-in (35-36 ft.-lb.)

Lugs for Phase and Neutral Connections (not supplied)					
NEMA Lug ^①	MFG	Wire Range	Type	No. Wires per phase	Torque (lb.-in.)
LK33750N2	Siemens	300-750 kcmil	Mechanical	3	500 ^②
LK34500N2	Siemens	1/0-500 kcmil	Mechanical	4	500
ALND-500-12-134	ILSCO	500 kcmil	Compression	4	NA ^③
ALND-700/750-12-134	ILSCO	750 kcmil	Compression	3	NA ^③

- ① Order one mechanical lug kit for mains and neutral. Additional lug kit is required for feed-thru terminals. Contact lug manufacturer for compression lug quantities supplied for each kit.
- ② Kit contains more than one lug type.
- ③ See lug manufacturer's instruction sheet supplied with the connector for tool, die, and number of crimps.

Short Circuit Current Rating

This device has a maximum short circuit current rating of 100,000 Amps RMS symmetrical at 240 Volts ~ when protected by Class R or J (600 amps max) or Class T or L (1200 amps max) fuses or Siemens type ND6, NXD6, HNXD6, SND6 or SHND6 circuit breakers rated not more than 1200 amps. The actual short circuit current rating is limited to the interrupting rating of the circuit breaker installed ahead of this device or the breaker installed in this device. Replacement breakers must be manufactured by Siemens and must be of the correct type and rating as indicated in the table below. Use of other circuit breakers in this device will void the warranty.

Breaker Type	Rating
JXD2-A, JXD6-A	65k AIC
HJXD6-A	100k AIC

USE ONLY NON-INTERCHANGEABLE TRIP BREAKER TYPES

IMPORTANT - for use with:

Module Description	Siemens Series#
Main Breakers	WB(M), WEB(M), WXB(M), BFT(M)
Switches	WMP, WS, WES, WXS
Tap/Terminal Boxes	WTB, WET, WT_PU, WTBN, WBT(M)
Pull Boxes	WMMB
Meter Module	(W)MM, (W)MT, (W)ML, (W)MK, (W)MLZ(F), (W)MN
Meter Combinations	WC, WCL, WCT,
Extension Box	WSP, WSPD
Bussed Elbow	BE, (W)ELB

Use HD Type Hubs if required

Trade Size (in)	Catalog No.
2"	EC56854
2-1/2"	EC56855
3"	EC56856
3-1/2"	EC56857
4"	EC56858
Cover Plate	EC56933S

Accessory:

ECMMGBE - Ground Bus Extension

Important: Do not allow petroleum based (hydrocarbon) sprays, chemicals, solvents or any paint to contact interior components. Petroleum based chemicals can cause degradation of electrical insulating materials.