

SIEMENS

Indoor/Outdoor Service Entrance Module

Catalog Number

WEB3200B
 WEB3200BU

Enclosure

Type 3R

Module Rating:

200 Amps, Max; See breaker for actual rating.
 208Y/120 Volts~, 60 HZ, 3 Phase, 4 Wire
 240/120 Volts~, 60 HZ, 3 Phase, 4 Wire, Delta (B Phase is High Leg)

For installation by Qualified Person in accordance with all local electrical codes and/or the National Electrical Code®.

Meets EUSERC specifications.

Suitable Only For Use As Service Equipment unless bond strap is removed. Apply appropriate label provided next to breaker handle.

For Underground Service Only.

Use 75°C Copper or Aluminum Conductors.

Connect Modules Using: **Cat. No.** **Torque**
 Quick Connect QC4 400-440 lb-in (35-36 ft.-lb.)

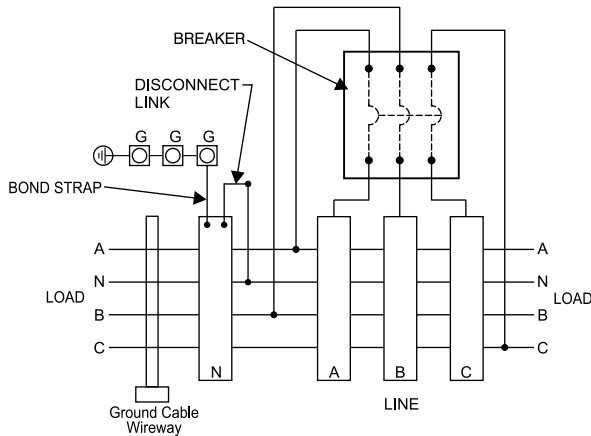

See adjacent labels for additional marking information.

49311384

Siemens Industry, Inc. Norcross, Georgia U.S.A.

D

40900151 0101 Rev.00

© The National Electrical Code is a registered trademark of the National Fire Protection Association.
 © 2019 Copyright Siemens Industry, Inc.

SIEMENS

Circuit breaker trip position is indicated by handle position midway between ON and OFF. To reset, move handle to OFF position, then turn ON.

Short Circuit Current Rating

This device has a maximum short circuit current rating of 100,000 amps RMS symmetrical at 120/240 Volts ~. The actual short circuit current rating is limited to the interrupting capacity of the circuit breaker installed. Replacement breakers must be manufactured by Siemens and must be of the correct type and rating as indicated in the table below. Use of other circuit breakers in this device will void the warranty.

Breaker Type	Rating
JXD2, JXD6	65k AIC
HJXD6	100k AIC

USE ONLY NON-INTERCHANGEABLE
TRIP BREAKER TYPES

Lugs for Phase and Neutral Connections (not supplied)

NEMA Lug ^①	MFG	Wire Range	Type	No. Wires per phase	Torque (lb.-in.)
LK31750N2	Siemens	300-750 kcmil	Mechanical	1	500
LK32500N2	Siemens	1/0-500 kcmil	Mechanical	2	500
2ACL-500	ILSCO	500 kcmil	Compression	2	NA ^②
2ACL-750	ILSCO	750 kcmil	Compression	1	NA ^②

- ① Order one mechanical lug kit for main breaker and neutral conversions. Contact lug manufacturer for compression lug quantities supplied for each kit.
- ② See lug manufacturer's instruction sheet supplied with the connector for tool, die, and number of crimps.

Ground terminal G: Wire size #4-300 kcmil Torque terminal to 250 lb.-in.

IMPORTANT - for use with:

Module Description	Siemens Series#
Main Breakers	WB(M), WEB(M), WXB(M), BFT(M)
Switches	WMP, WS, WES, WXS
Tap/Terminal Boxes	WTB, WET, WT PU, WTBN, WBT(M)
Pull Boxes	WMMB
Meter Module	(W)MM, (W)MT, (W)ML, (W)MK, (W)MLZ(F), (W)MN
Meter Combinations	WC, WCL, WCT,
Extension Box	WSP, WSPD
Bussed Elbow	BE, WELB

Important: Do not allow petroleum based (hydrocarbon) sprays, chemicals, solvents or any paint to contact interior components. Petroleum based chemicals can cause degradation of electrical insulating materials.

49311385

Siemens Industry, Inc. Norcross, Georgia U.S.A.

D

40900151 0201 Rev.00

© 2019 Copyright Siemens Industry, Inc.