

SIEMENS

Outdoor Uni-PAK All-In-One Metering

Catalog Number

Enclosure

WP4611, WP4611RJ, WP4611RJB

Type 3R

Main Bus Rating: 400 Amps
120/240 V~, 1 Phase, 3 Wire
208Y/120 V~, 1 Phase, 3 Wire
(5th jaw may be required)

Meter Socket Rating: 125A Continuous
Branch Rating: 125A Max.

For installation by Qualified Person in accordance with all local electrical codes and/or the National Electrical Code ®.

Terminal	Wire Size	Torque
A, B, N1	750 kcmil -1/0 CU-AL (2) 250kcmil - 1/0 AL (2) 3/0 - 1/0 AWG CU	500 LB-IN
G	300 kcmil - #4 AWG	275 LB-IN
N2/Equip GND	#2/0 - 4 AWG	110 LB-IN
Alt. Lug Kit WPLK2400	(2) 300 kcmil-#4 AWG	275 LB-IN

Suitable Only For Use As Service Equipment.

Install no more than six main disconnecting means.

For overhead or underground service.

Use 60/75°C Copper or Aluminum Conductors for all panel terminals and on circuit breaker terminals when breakers are so marked.

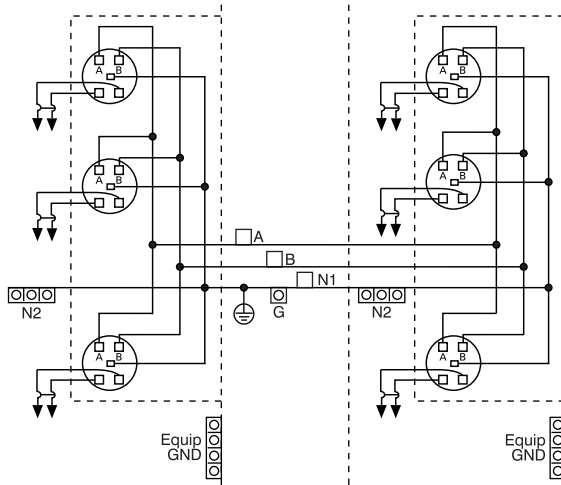

SIEMENS

Outdoor Uni-PAK All-In-One Metering

General Information:

Circuit breaker overload trip position is indicated by handle position midway between ON and OFF. To reset, move handle to OFF position, then turn ON.

Short Circuit Current Rating

The maximum short circuit current rating of this device is 100,000 RMS symmetrical amperes, 120/240 V~. The actual rating is limited to the lowest interrupting rating of any circuit breaker installed. Use only Siemens type QP, QPH, HQP, HQPH, MP-T, MP-HT or MP-MT circuit breakers. Use of other circuit breakers in this device will void the warranty.

Accessories

5th Jaw, 6 or 9 o'Clock Position. ECMF5
Insulated 5th Jaw, 6 or 9 o'Clock Pos. ECMF5i
Meter Socket Cover Plate (Ring Type) ECPP
Meter Socket Cover Plate (Ringless) ECCP3
Horn By-Pass (Ringless Only). ECMFH

Use HD Type Hubs if required

Trade Size (in)	Catalog No.
2"	EC56854
2-1/2"	EC56855
3"	EC56856
3-1/2"	EC56857
4"	EC56858
Closure Plate	EC56933S

Important: Do not allow petroleum based (hydrocarbon) sprays, chemicals, solvents or any paint to contact interior components. Petroleum based chemicals can cause degradation of electrical insulating materials.