

Catalog Number: UAT437-PG

Features and Ratings

- Ringless Type Meter Socket
- 200A Continuous, 250A Max., 600V AC
- Outdoor Enclosure (NEMA Type 3R)
- Aluminum Enclosure
- 1 Phase, 3 Wire
- 4 Jaw Meter Socket
- Meter Socket Type UAT4
- For Underground Service Only
- Stainless Steel Hasp and Latch

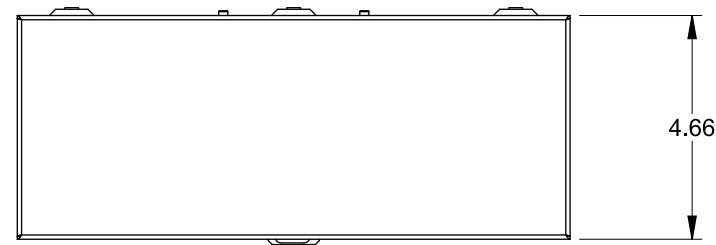

Connectors, Wire Sizes and Torques

CONNECTOR	WIRE SIZE	TORQUE
LINE, LOAD, NEUTRAL*	#6 - 350 kcmil	250 IN.-LBS.
GROUND	#2 - 14 AWG	50 IN.-LBS.

* External Hex Drive 1/2"
 * Internal Hex Drive 5/16"

Accessories

Meter Opening Cover Plate
 Cat No: H659-0162

5th Jaw Kit
 Cat. No: EC659-0121

VIEW SHOWN WITH COVER REMOVED

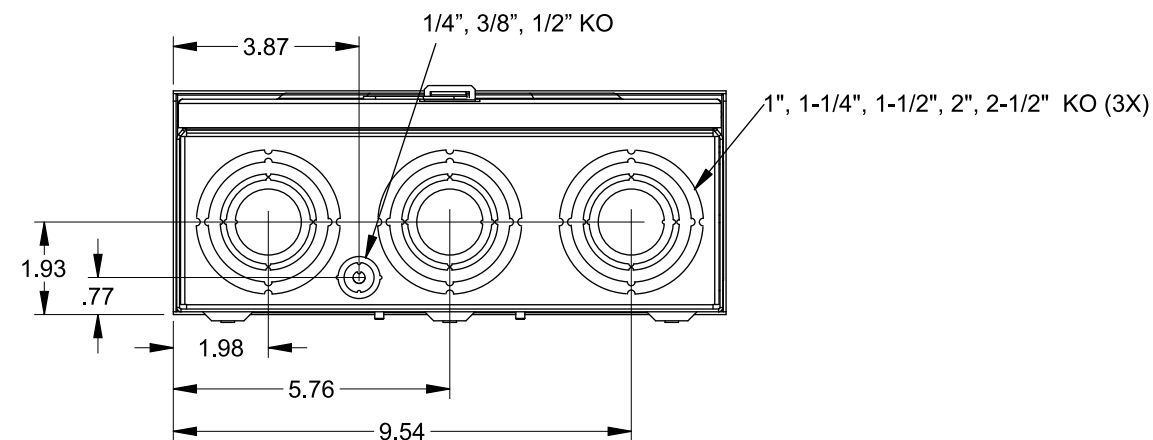
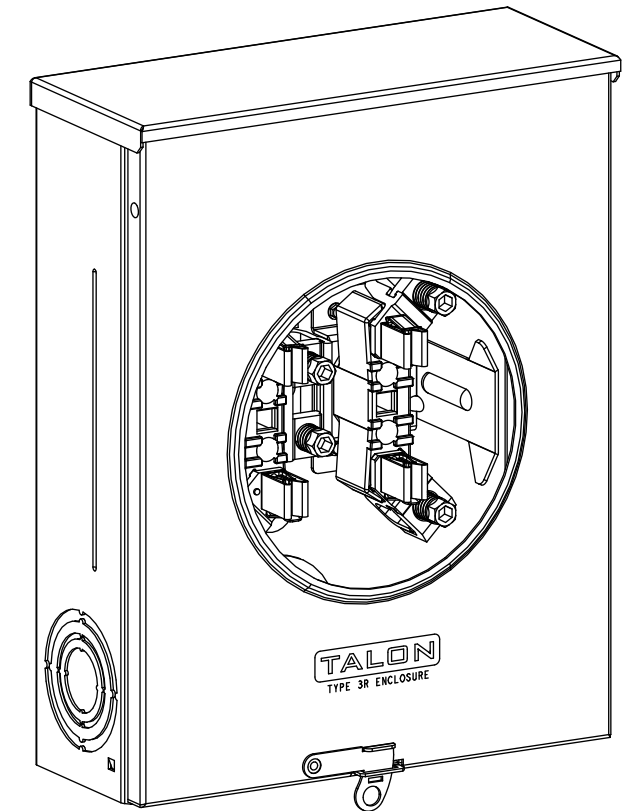
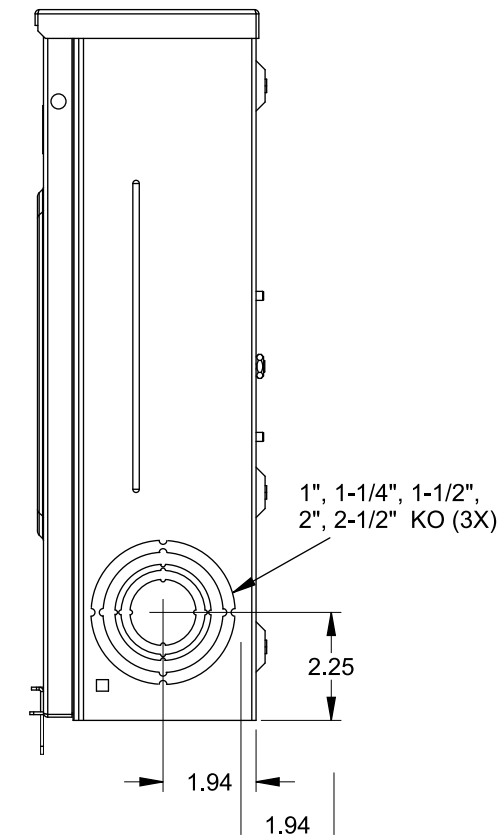
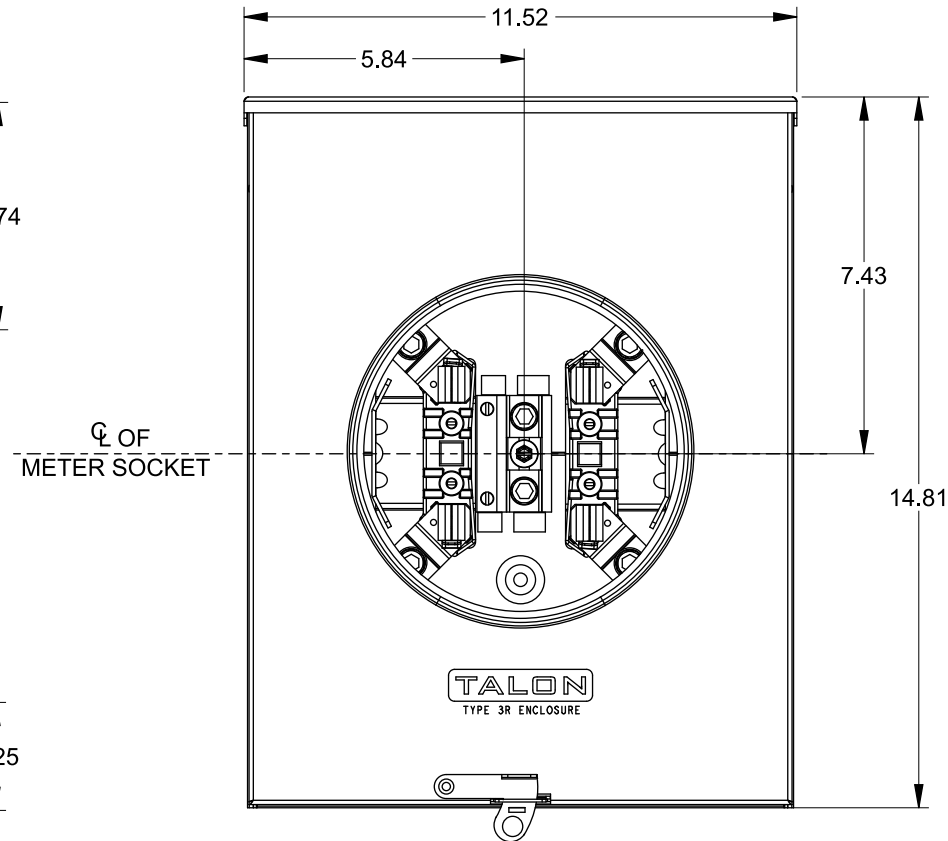
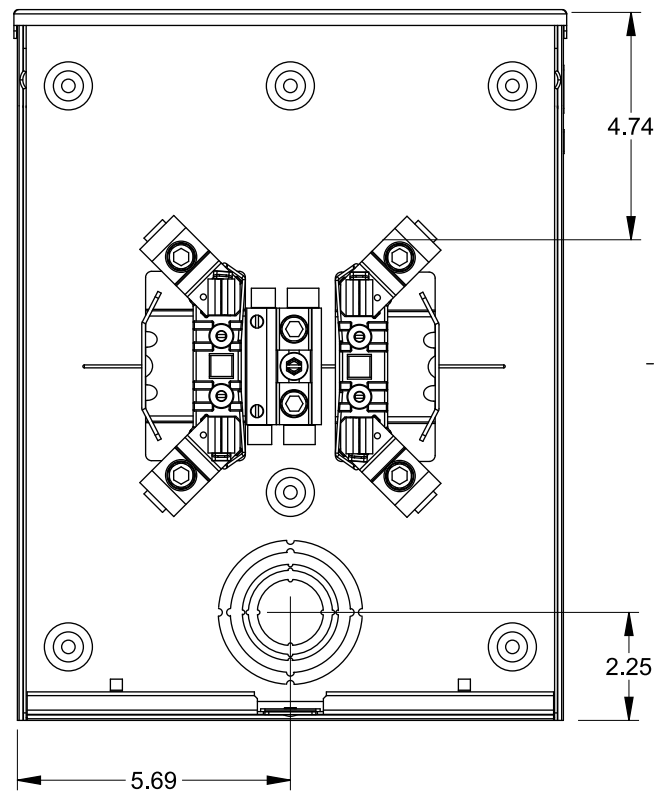

© 2015 Copyright Siemens Industry, Inc.

TALON
Meter Socket

Description: **200A Cont, 4 Jaw, UAT4, 600V AC, Aluminum Enclosure**

JEL 6/30/15 | DO NOT SCALE DRAWING | Dwg No: **UAT437-PG**