

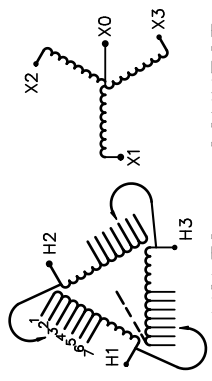



REVISION	DATE	BY	DATE	BY
		DRAWN	16/08/09	PP
		CHEK'D		
		VERIF'D		

Confidential - Property of Siemens Industry, Inc.	
CUSTOMER	
ORDER NO.	DWG. NO.
	3F3Y300K13BCD16 SH 1 OF 2

SIEMENS

<p>CATALOG NO. 3F3Y300K13BCD16</p> <p>SERIAL NO. SERIES H</p> <p>300 kVA 60 Hz 3 PHASE</p> <p>5.5 % IMP AT 100 °C</p> <p>80 °C RISE 30 °C AVG. AMBIENT</p> <p>220 °C TEMP CLASS 40 °C MAX. AMBIENT</p> <p>PRIMARY (H1 H2 H3) 480V V 10 kV BIL</p> <p>SECONDARY(X0 X1 X2 X3) 208Y/120V V 10 kV BIL</p> <p>WINDING MATERIAL CU</p> <p>ENCLOSURE TYPE 3R WEIGHT 2800LBS</p> <p>ENERGY EFFICIENCY EXCEEDS CSA 802.2-2012 DOE 10 CFR PART 431:2016</p> <p>SPACINGS BETWEEN ANY VENTILATED ENCLOSURE PANEL AND ANY ADJACENT WALL SHALL BE A MINIMUM OF 5 INCHES EXCEPT WHEN WALL MOUNTED USING APPROVED WALL MOUNTING KIT ELECTROSTATIC SHIELD</p> <p>SUITABLE FOR NONSINUSOIDAL CURRENT LOAD WITH K-FACTOR NOT TO EXCEED K-13 SUITABLE FOR INDOOR OR OUTDOOR LOCATIONS BEFORE HANDLING, INSTALLING AND OPERATING; SEE INSTRUCTION MANUAL</p> <p>NEMA Class ANN Dry Type Transformer Siemens Industry, Inc. Norcross, GA 6810087e</p>	 <p style="text-align: center;">VOLTS CONNECT</p> <table style="margin-left: auto; margin-right: auto;"> <tr><td>1</td><td>504</td></tr> <tr><td>2</td><td>492</td></tr> <tr><td>3</td><td>480</td></tr> <tr><td>4</td><td>468</td></tr> <tr><td>5</td><td>456</td></tr> <tr><td>6</td><td>444</td></tr> <tr><td>7</td><td>432</td></tr> </table>	1	504	2	492	3	480	4	468	5	456	6	444	7	432	<p style="text-align: center;">TYPE K</p> <div style="display: flex; justify-content: space-around; align-items: center;">    </div> <p style="text-align: center;">LISTED E112313</p> <p style="font-size: small;">SEISMIC QUALIFICATIONS, FLOOR MOUNT ONLY OSP-0136-10 IBC 2012/ASCE 7-10 SDS<=2.0g z/h=1 p=1.5</p>
1	504															
2	492															
3	480															
4	468															
5	456															
6	444															
7	432															



FRONT VIEW

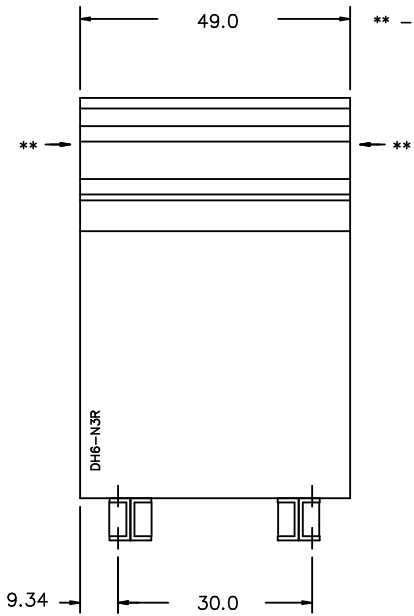

** - Recommended cable entry locations only
cutouts & gland plates not provided.

SIDE VIEW

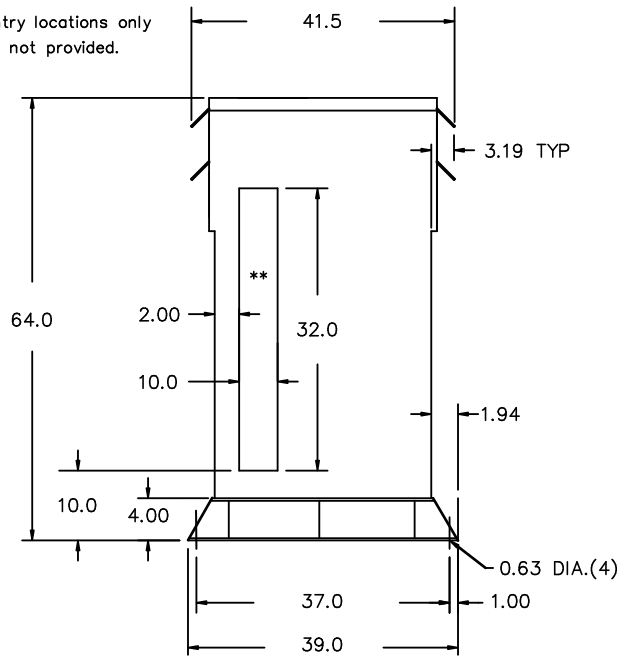

All Dimensions in inches

ENCLOSURE COLOR : ANSI 61 GREY - OUTDOOR

H.V.1. TERMINAL DETAIL

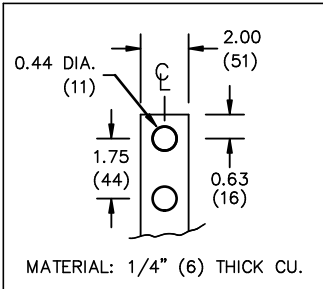

X1,2,3 TERMINAL DETAIL

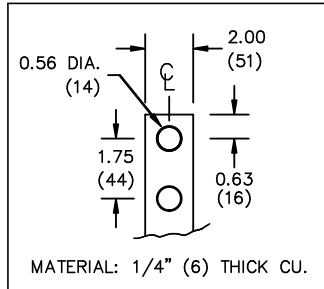

X0 TERMINAL DETAIL

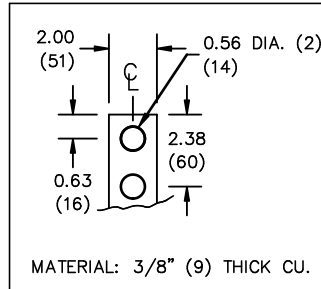

CUSTOMER NOTES:

- HV1 TERMINATED AT TOP FRONT
- X1,2,3 TERMINATED AT BOTTOM FRONT
- X0 TERMINATED AT BOTTOM FRONT
- 2 X 100% RATED NEUTRAL PROVIDED

Confidential - Property of
Siemens Industry, Inc.

REVISION	DATE	BY	DATE	BY
		DRAWN	16/08/09	PP
		CHEK'D		
		VERIF'D		

CUSTOMER	
ORDER NO.	DWG. NO. 3F3Y300K13BCD16
SH 2 OF 2	