

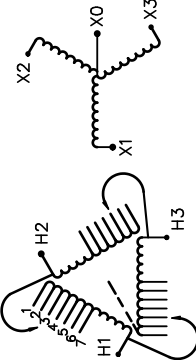

REVISION	DATE	BY	DATE	BY
		DRAWN	16/07/25	PP
		CHEK'D		
		VERIF'D		

Confidential - Property of <b>Siemens Industry, Inc.</b>	
CUSTOMER	
ORDER NO.	DWG. NO.
	3F3Y300ESCLN5D16 SH 1 OF 2

# SIEMENS

<p>CATALOG NO. 3F3Y300ESCLN5D16</p> <p>SERIAL NO. SERIES H</p> <p>300 kVA 60 Hz 3 PHASE</p> <p>3.7 % IMP AT 170 °C</p> <p>150 °C RISE 30 °C AVG. AMBIENT</p> <p>220 °C TEMP CLASS 40 °C MAX. AMBIENT</p> <p>PRIMARY ( H1 H2 H3 ) 480V V 10 kV BIL</p> <p>SECONDARY( X0 X1 X2 X3 ) 208Y/120V V 10 kV BIL</p> <p>WINDING MATERIAL CU</p> <p>ENCLOSURE TYPE 3R WEIGHT 1900 LBS</p> <p>ENERGY EFFICIENCY EXCEEDS CSA C802.2-2012 DOE 10 CFR PART 431:2016</p> <p>SPACINGS BETWEEN ANY VENTILATED ENCLOSURE PANEL AND ANY ADJACENT WALL SHALL BE A MINIMUM OF 5 INCHES EXCEPT WHEN WALL MOUNTED USING APPROVED WALL MOUNTING KIT ELECTROSTATIC SHIELD</p> <p>SOUND LEVEL IS 5 DB LOWER THAN NEMA ST20 REQUIREMENTS</p> <p>SUITABLE FOR INDOOR OR OUTDOOR LOCATIONS BEFORE HANDLING, INSTALLING AND OPERATING; SEE INSTRUCTION MANUAL</p> <p>NEMA Class ANN Dry Type Transformer Siemens Industry, Inc. Norcross, GA <small>dsu0086e</small></p>	 <p>VOLTS CONNECT</p> <table style="margin-left: 20px;"> <tr><td>1</td><td>504</td></tr> <tr><td>2</td><td>492</td></tr> <tr><td>3</td><td>480</td></tr> <tr><td>4</td><td>468</td></tr> <tr><td>5</td><td>456</td></tr> <tr><td>6</td><td>444</td></tr> <tr><td>7</td><td>432</td></tr> </table>	1	504	2	492	3	480	4	468	5	456	6	444	7	432	<p>TYPE K</p>  <p>DRY TYPE TRANSFORMER 77UL5 E112313</p>  <p>LR 3902</p> <p>SEISMIC QUALIFICATIONS, FLOOR MOUNT ONLY OSP-0136-10 IBC 2012/ASCE 7-10 SDS&lt;=2.0g z/h=1 Ip=1.5</p>
1	504															
2	492															
3	480															
4	468															
5	456															
6	444															
7	432															

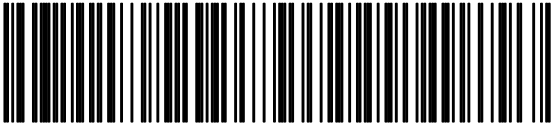

3F3Y300ESCLN5D16

FRONT VIEW

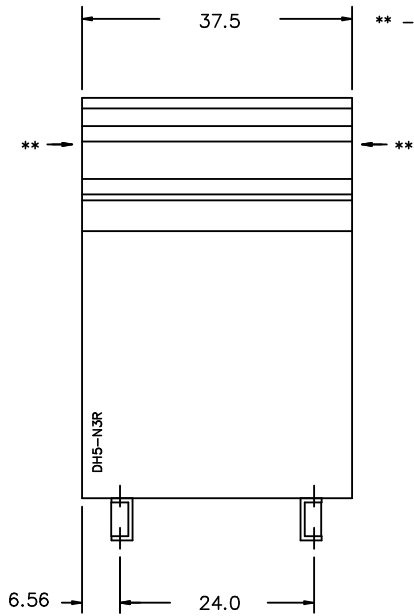

\*\* - Recommended cable entry locations only  
cutouts & gland plates not provided.

SIDE VIEW

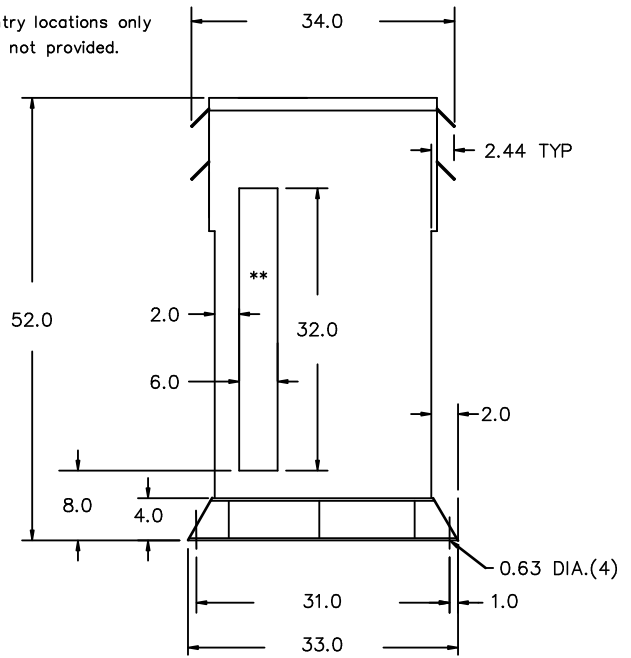

All Dimensions in inches

ENCLOSURE COLOR : ANSI 61 GREY - OUTDOOR

H.V.1. TERMINAL DETAIL

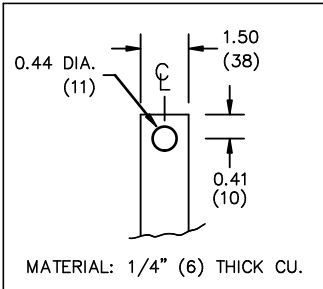

L.V.1. TERMINAL DETAIL

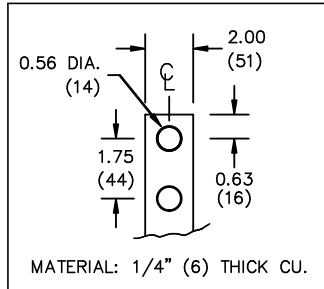

CUSTOMER NOTES:

- HV1 TERMINATED AT TOP FRONT
- LV1 TERMINATED AT BOTTOM FRONT

Confidential - Property of  
Siemens Industry, Inc.

REVISION	DATE	BY	DATE	BY
		DRAWN	16/07/25	PP
		CHEK'D		
		VERIF'D		

CUSTOMER	
ORDER NO.	DWG. NO.
	3F3Y300ESCLN5D16 SH 2 OF 2

0.1 ppcossinos 2016/07/25 14:44