

## Installation Instructions

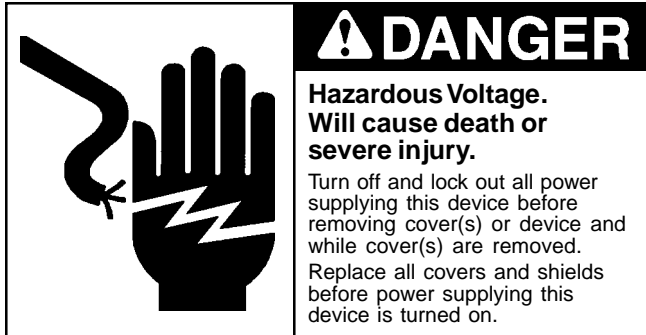

**NOTE:** Accessory installation should be complete before the circuit breaker is mounted and connected. (See installation instructions supplied with the Accessory before proceeding.)

C. Make sure the device is in the "TRIPPED" or "OFF" position. Depress the red trip button (See Fig. 2) or turn the breaker off.



### SAFETY INSTRUCTIONS

**NOTE:** This instruction outlines the recommended installation procedure.

### Introduction

The PM Frame circuit breaker line includes the PM6 circuit breaker. These devices are rated for operating voltages up to 600 VAC, 50/60 Hz.

PM Frame circuit breaker can only be placed into service by using the proper connect-all mounting assembly.

### Installation

The PM Frame devices are for use in individual enclosures, panelboards or other approved equipment.

The installation procedure consists of inspecting, attaching required accessories, mounting the device and connecting and torquing the line and load wire connectors.

Unmounted wire connectors (where required) are available as separate catalog items. See Fig. 5 for options on installation.

### Circuit Breaker Preparation

- Before installing or servicing breaker, turn off and lock out all power to prevent incidental or accidental contact.
- Make sure that the device is suitable for the installation by comparing nameplate ratings with system requirements. Inspect the device for completeness and check for any damage before mounting.

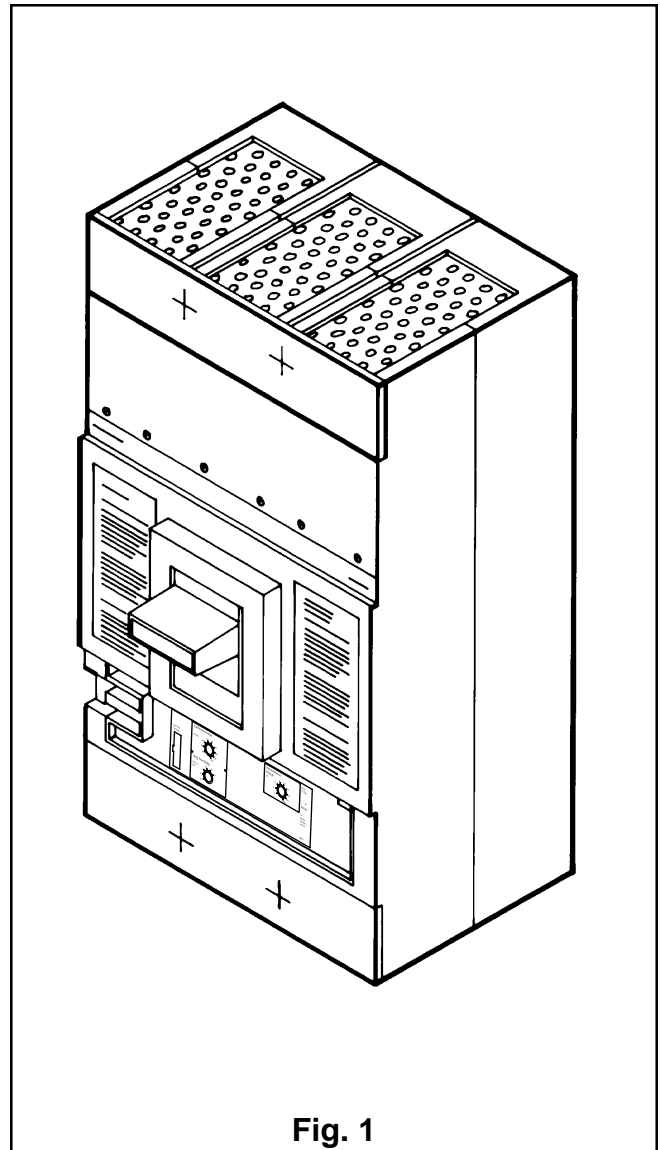

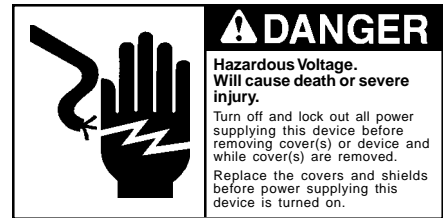

# Installation Instructions

## Mounting of Breaker onto Connect—All Assembly

- A. Remove the load and line terminal shields (D, Fig. 3 & 4) by loosening the two terminal shield screws (E, Fig. 3 & 4). Also remove end plates (J, Fig. 3 & 4).
- B. Place breaker onto protruding connect-all terminals and fasten breaker to molded mounting base with four slotted fillister head 3/8-16 x 1-3/4 long screws, washers, and lockwashers (G, Fig. 3 & 4). Tighten mounting screws to a torque of 5 to 6 ft. lbs.
- C. Fasten breaker terminal to connect-all terminals with two hex head 3/8-16 x 1-3/4" long copper alloy bolts, washers and lock washers (F, Fig. 3 & 4) per terminal. Tighten these bolts to a torque of 9 to 10 ft. lbs.
- D. Replace all end plates (J, Fig. 3 & 4) and line and load terminal shields (D, Fig. 3 & 4). Tighten terminal shield screws securely.
- E. After mounting the circuit breaker, line and load terminals and accessory terminals should be connected. Install wire connectors with correct torque requirements (Refer to Fig. 4). Torque values for line and load connectors are provided on the circuit breaker nameplate and in Table 1, Page 2 of 6. Ensure that wire and wire connectors are fully engaged on terminals and that connectors are flush with end of terminal.

## Circuit Breaker Manual Operation

Manual operation of the circuit breaker is controlled by the circuit breaker handle and the Push-To-Trip button. The circuit breaker handle has three indicating positions, two of which are molded into the handle to indicate ON and OFF. The third position indicates a TRIP position and is between ON and OFF positions. (See Fig. 2)

- A. Circuit Breaker Reset  
 After tripping, the circuit breaker is reset by moving the circuit breaker handle to the reset position and then moving the handle to the ON position.
- B. Push-To-Trip Button  
 The Push-To-Trip button checks the tripping function and is used to manually exercise the operating mechanism.

## Maintenance

Experience has shown that properly applied molded case circuit breakers normally do not require maintenance. However, some industrial users may choose to establish an inspection and maintenance procedure to be carried out on a regular basis. For detailed information, consult applicable NEMA publications or your local Siemens sales office.

**NOTE:** Do not spray or allow any petroleum based chemicals, solvents or paints to contact the molded parts or nameplates.

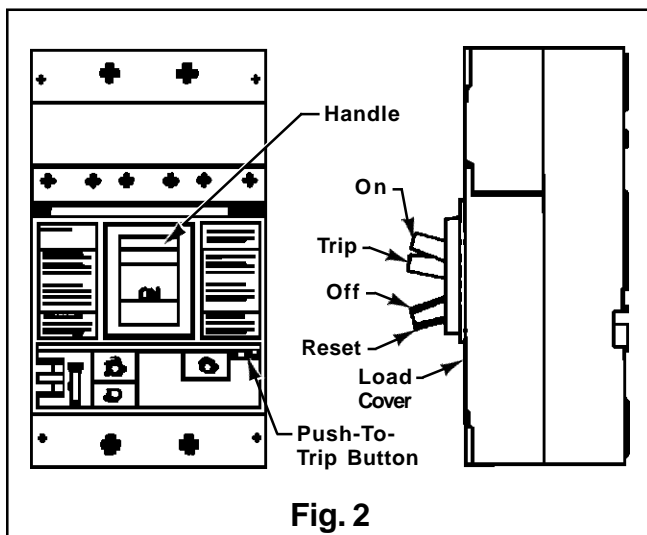

**TABLE 1**

Catalog Number	Wire Range	Torque	
		Cable Clamping Screw	Connector Mounting Screw
TA5P600	300-400 kcmil Cu/Al	600 lb-in. [67.79 N-m]	300 lb-in. [33.89 N-m]
	500-600 kcmil Cu/Al	780 lb-in. [88.13 N-m]	
TA4P750	600-750 kcmil Cu/Al	480 lb-in. [54.23 N-m]	300 lb-in. [33.89 N-m]
TA6R600	300-600 kcmil Cu/Al	600 lb-in. [67.79 N-m]	375 lb-in. [42.37 N-m]
TC5R600	300-600 kcmil Cu ONLY	600 lb-in. [67.79 N-m]	375 lb-in. [42.37 N-m]

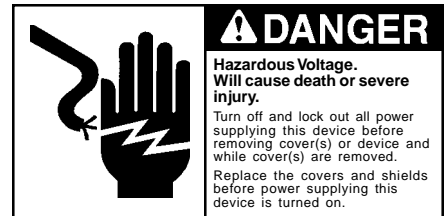

# Installation Instructions

## ELECTRONIC OPERATION

The setting dials on the face of the electronic trip unit are rotary switches that must be properly set to mechanical detent (click stop) positions. An improper switch setting will cause the trip unit to default ( as a fail safe condition) to the lowest permissive setting and, consequently, may result in unintentional or nuisance tripping.

### Continuous Current Switch $I_r = \%I_n$

Adjustments made to this switch can change the continuous amps rating of the breaker to 20, 30, 40, 50, 60, 70, 80, 90 or 100% of the maximum continuous amps rating ( $I_n$ ) of the circuit breaker. The diagram below shows the settings possible on this switch:

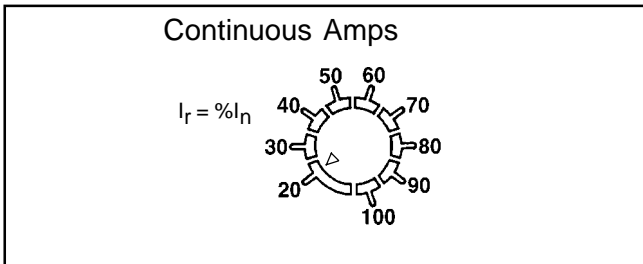

### Long Time Delay Seconds @ $6xI_r$

The adjustable long time delay switch allows for selection of long time delays based on  $I^2t$  curves at six time the continuous amps setting ( $I_r$ ). The diagram below illustrates the possible settings for this switch.

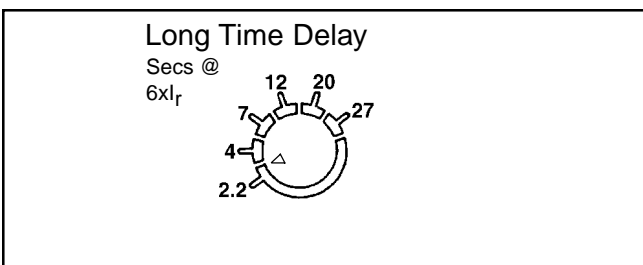

### Instantaneous Trip Switch $xI_r$

The adjustable instantaneous trip switch allows selection of a tripping point from 2 to 30 times the ampere rating. The MAX setting sets the instantaneous pickup to the override level (see note below). The diagram below illustrates the possible settings for this switch.

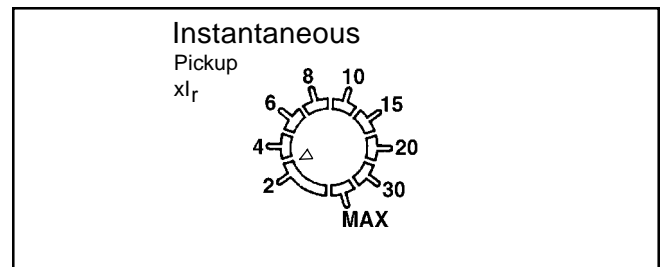

**NOTE:** Breaker contains an override at multiples of the maximum continuous current rating. These multiples are (7) times for 1400A breakers and Six (6) times for 1600A breakers. Above these levels, the short time delay is no longer operational. The breaker will trip instantaneously.

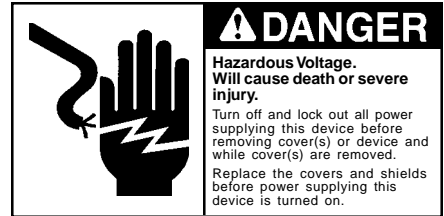

# Installation Instructions

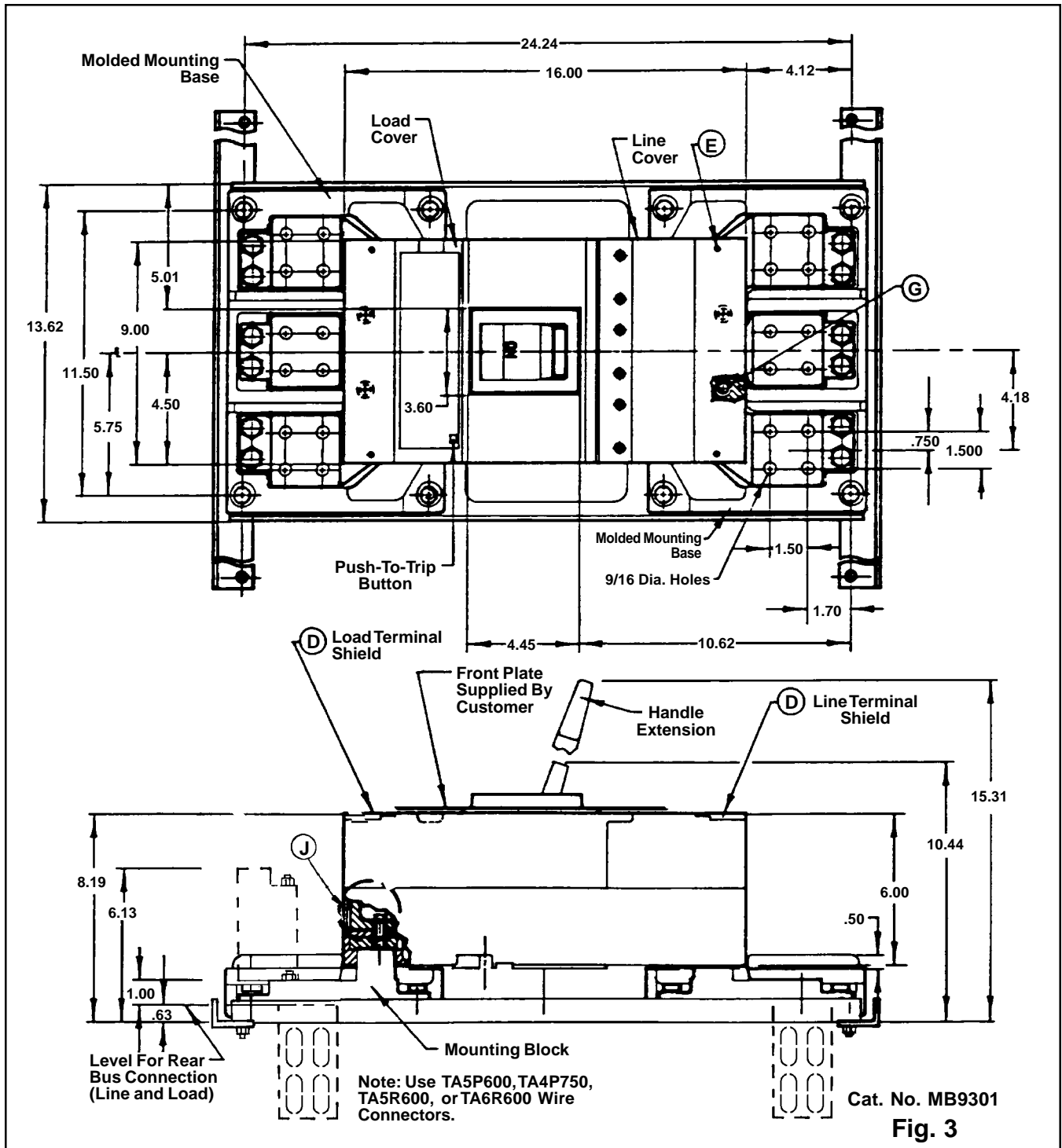



# Installation Instructions

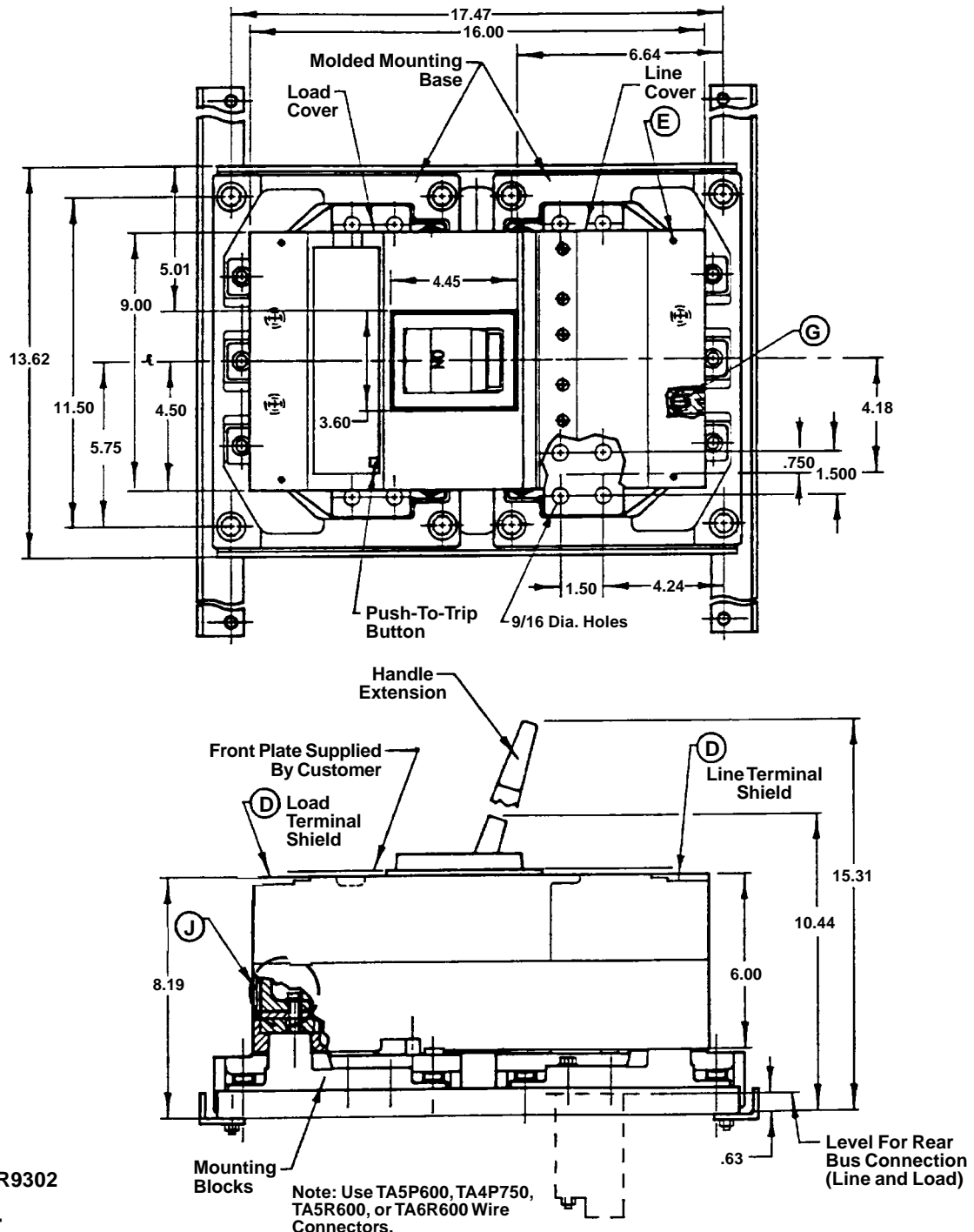

Cat. No. MBR9302

**Fig. 4**

	<b>⚠ DANGER</b>
	<b>Hazardous Voltage.</b> Will cause death or severe injury.
	Turn off and lock out all power supplying this device before removing cover(s) or device and while cover(s) are removed. Replace the covers and shields before power supplying this device is turned on.

# Installation Instructions

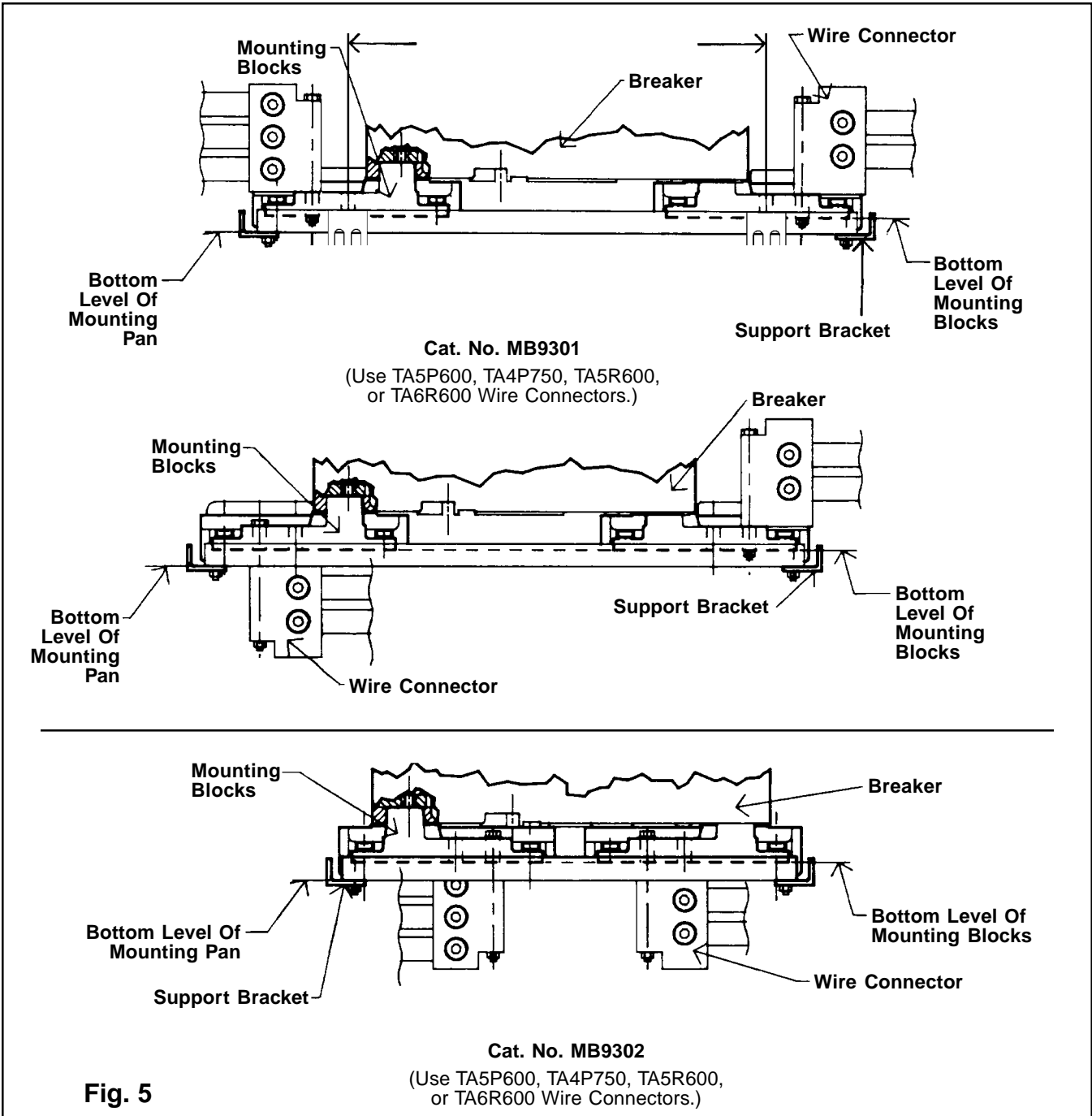

**Fig. 5**

**This product is covered by the following patent: 4,631,525.**