

Installation Instructions



⚠ DANGER

Hazardous voltage. Will cause death or serious injury.

Turn off and lock out all power supplying the circuit breaker prior to cover(s) removal or while cover(s) are removed and when installing any internal or external accessory.

Replace the cover(s) and shield(s) before power supplying this device is turned on.



SAFETY INSTRUCTIONS

GENERAL:

The Sensitrip Ammeter Display Unit (SADU) is a direct plug-in or panel mounted device for use with the Sentron Sensitrip III Molded Case Circuit Breaker (MCCB) series. Accessory catalog number SADURMK18 must be used when panel mounting this device.

The SADU external accessory provides metering capabilities and trip indication from the Sentron Sensitrip III Molded Case Circuit Breakers.

The device has two sources of power: trip unit and a 9V battery. The 9V battery provides power when the trip unit is not energized. All logged data is maintained in volatile RAM. To preserve the logged data, the battery must be replaced when the display flashes BATTERY IS LOW. While the battery will last approximately 5 years in normal operation, the display should be checked monthly for a low battery.

NOTE: At very low current levels, the metering functions are not fully functional. When the circuit breaker load exceeds 3-6% (3 phase) or 10-20% (1 phase), the display is continuously on and fully functional.

Pressing the MENU or DATA switches will turn on the display. To conserve battery life, the display automatically turns off after 15 seconds when the breaker load is too low and the input switches are not pressed.

When the display turns on, the PHASE CURRENTS sub menu is automatically displayed unless the circuit breaker tripped. After a trip, the display defaults to the first entry in the trip log and remains there until one of the input switches are pressed. See Figure 6 for a graphical representation of the menu structure.

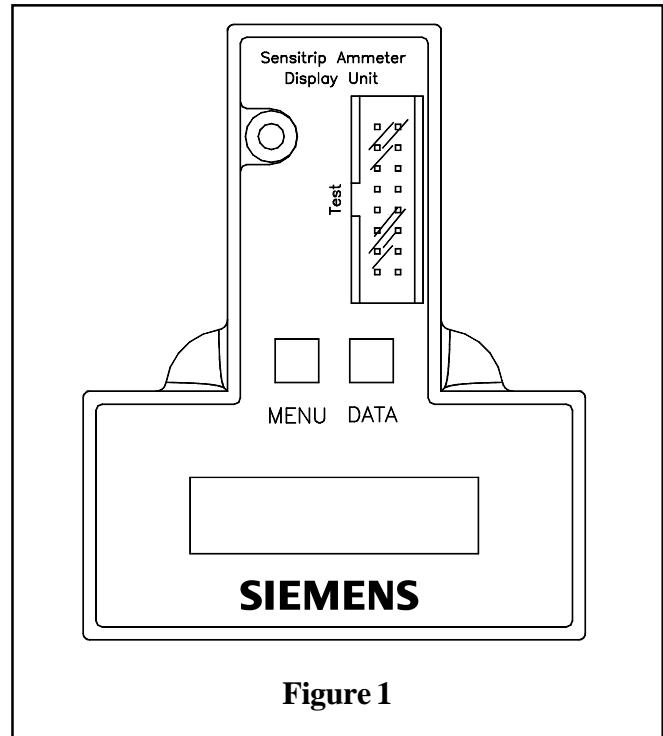
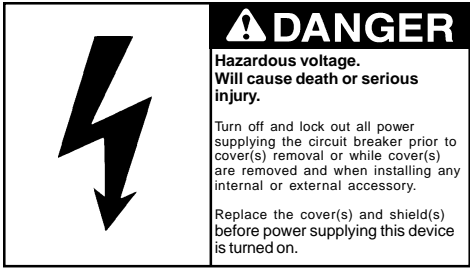

Figure 1

FEATURES:

- 1) Ammeter Display
 - Phase Currents
 - Average Current
 - Ground Current
 - Average Current Demand
 - Current Unbalance
- 2) Breaker Status
 - Normal
 - Overload (Impending Trip)
- 3) Time Stamped Trip Log (5 most recent)
 - Time
 - Date
 - Trip Cause: Long Time (LT)
Short Time (ST)
Short Circuit (SC)
Ground Fault (GF)
- 4) Max Log
 - Max Phase Current
 - Max Average Current
 - Max Ground Current
 - Max Current Unbalance
 - Max Average Current Demand



Installation Instructions

INSTALLATION:

Parts List: (included with cat. no. SADU)

- 1 - SADU Electronic Assembly
- 1 - 9V Lithium Battery
- 1 - J/L Installation Kit
 - 1 - Plastic Mounting Spacer
 - 1 - 2" long Pan Head Screw
 - 1 - Flatwasher
 - 1 - Split Lockwasher
- 1 - M/N/P Installation Kit
 - 1 - Clear Plastic Trip Unit Cover with Insert
 - 1 - 1 3/4" long Pan Head Screw
 - 1 - 1/8" long Aluminum Spacer
 - 1 - Flatwasher
 - 1 - Split Lockwasher





CAUTION: SADU and Trip Unit are subject to damage from static charge. Prior to removing unit from static bag, discharge any static charge by touching a grounded object.

- 1) With a small Phillips screwdriver, remove the 2 screws on the back of the unit.
- 2) Remove back cover and fold over so there is access to battery terminals.
- 3) Connect the supplied 9V battery onto the battery terminals. Position battery in unit so that the leads on the battery terminal are not pinched.
- 4) Replace back cover and secure with screws. **DO NOT OVER TORQUE SCREWS.** Maximum torque is 8 in./lbs.
- 5) Confirm unit is functional by setting the date and time. Refer to OPERATION section for operating menu structure.
- 6) If unit is not functional, remove the 2 screws and back cover. Press the RESET switch above the battery. Replace the back cover and secure with screws. Repeat step 5.
- 7) Install unit onto circuit breaker. Perform step 8 for installation on JD or LD frame circuit breakers. Perform step 9 for installation on MD, ND or PD frame circuit breakers. If installing unit with remote mounting kit (SADURMK18), follow installation instructions supplied with remote mounting kit (801410).
- 8) **Procedure for installation on JD and LD frame circuit breakers** (See figures 2 and 3)
 - a) If the switchgear covers the front of the circuit

breaker, see figure 2 for the maximum spacing allowable to install unit.

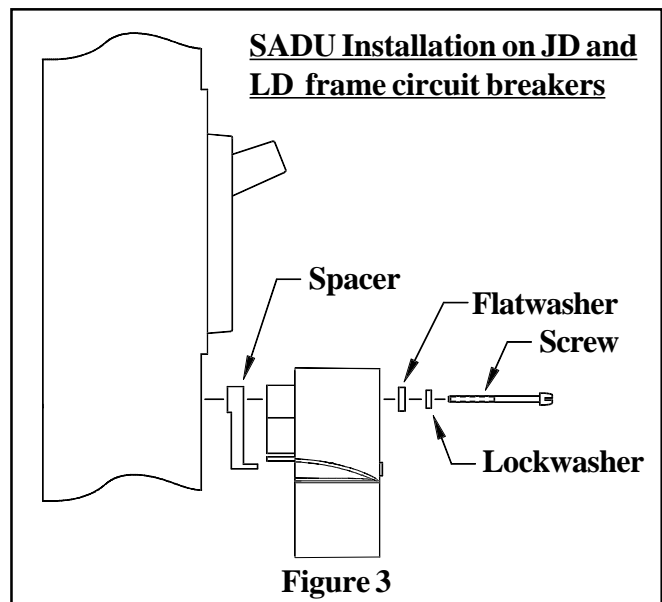
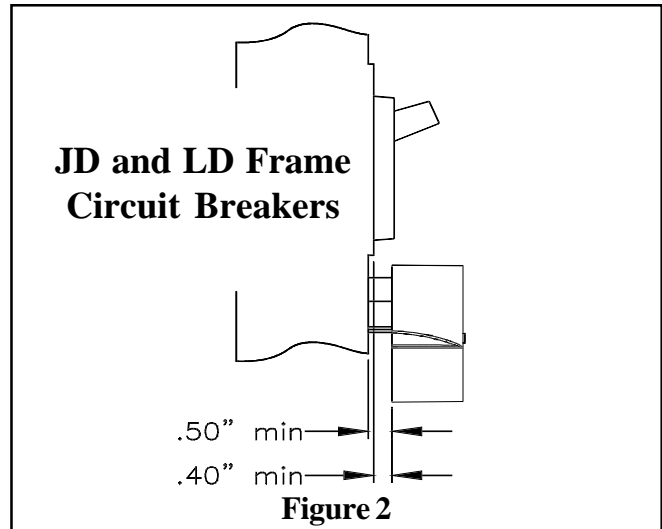
- b) If an Expansion Plug (Cat. No. EP) is installed in test connector, remove ribbon cable temporarily. Otherwise, remove the clear protective cover over the test connector on the trip unit.
- c) Carefully insert the ribbon cable on the SADU into the trip unit's 16-pin test connector.
- d) Insert the plastic mounting spacer between the trip unit and SADU. See figure 3.
- e) Secure the SADU to the trip unit using the sup-



	⚠ DANGER
	Hazardous voltage. Will cause death or serious injury.
	Turn off and lock out all power supplying the circuit breaker prior to cover(s) removal or while cover(s) are removed and when installing any internal or external accessory. Replace the cover(s) and shield(s) before power supplying this device is turned on.

Installation Instructions

plied 2" retaining screw, flatwasher and lockwasher. DO NOT OVERTORQUE. Maximum torque is 4 in./lbs. See figure 3

- f) Re-connect Expansion Plug ribbon cable into SADU test connector if necessary.

- 9) **Procedure for installation on M, N and P frame circuit breakers** (See figures 4 and 5)
 - a) If the switchgear covers the front of the circuit breaker, see figure 4 for the maximum spacing allowable to install unit.
 - b) If an Expansion Plug (Cat. No. EP) is installed in test connector, remove ribbon cable temporarily.
 - c) Remove the clear protective cover on the trip unit.
 - d) Install the new clear plastic trip unit cover supplied and secure with nut from original cover.
 - e) Carefully insert the ribbon cable on the SADU into the trip unit's 16-pin test connector.
 - f) Secure the SADU to the trip unit using the supplied 1 3/4" retaining screw, aluminum spacer, flatwasher and lockwasher. DO NOT OVERTORQUE. Maximum torque is 4 in./lbs. See figure 5.
 - g) Re-connect Expansion Plug ribbon cable into SADU test connector if necessary.

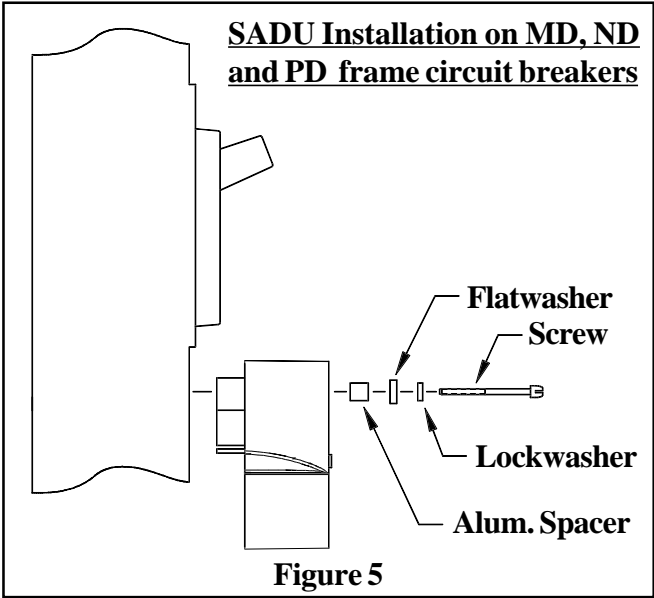

numeric liquid crystal display (LCD) is easily controlled by the MENU & DATA buttons.

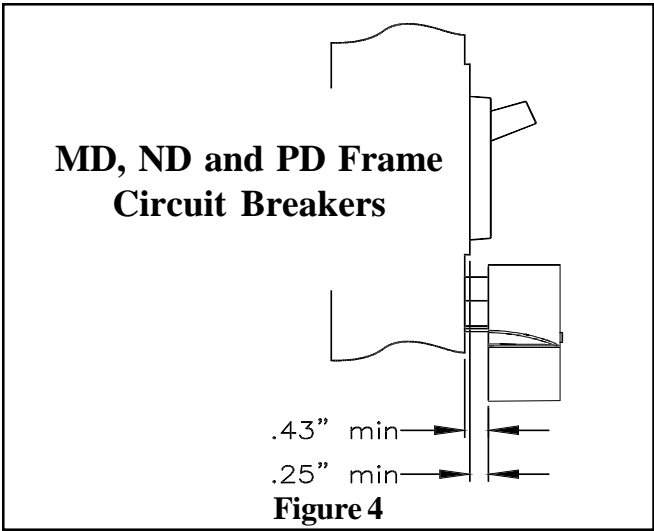

OPERATION:

- 1) **FRONT PANEL DISPLAY**
 The Sensitrip Ammeter Display Unit (SADU) incorporates two control buttons (MENU & DATA) for scrolling through the menus. The 2 line by 16 character alpha-

- 2) **MENU STRUCTURE**
 The display is organized into a menu structure. There are 8 main menus and 20 sub menus. Refer to figure 6 for a graphical representation of the menu structure. The display is updated every 2 seconds.

Phase Currents
 The Phase Currents menu displays phase A, B, and C amps. When the circuit breaker load is too low the display shows TRIP UNIT NOT COMMUNICATING.

Meter
 The Meter menu displays the average amps, ground fault amps, and the maximum phase percent current unbalance. If the trip unit does not have ground fault, N/A is displayed. When the circuit breaker load is too low the display shows TRIP UNIT NOT COMMUNICATING.

Trip Unit Status
 The Trip Unit Status menu displays the present status of the trip unit. When the circuit breaker load is too low the display shows TRIP UNIT NOT COMMUNICATING.

NORMAL = indicates the circuit breaker load does

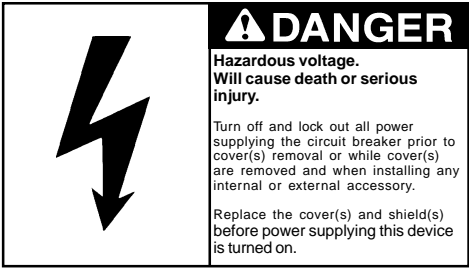

Installation Instructions

not exceed the trip unit Continuous Current setting.
OVERLOAD = indicates the circuit breaker load exceeds the trip unit Continuous Current setting and a trip is pending.

Avg Amp Demand

The Avg Amp Demand menu displays the present average amperage demand and demand time period. The average amperage demand is updated every minute and consists of a 15 minute demand period. When the circuit breaker load is too low, the average amperage demand and demand time period is restarted and the display shows TRIP UNIT NOT COMMUNICATING.

Trip Log

The Trip Log menu displays the last five circuit breaker trips. Each log displays the trip function and time/date of the trip. The time and date in the Set Clock menu must be correct to record an accurate timestamp.

- LT = Long Time; indicates a trip based upon the trip unit's Continuous Current and Long Time Delay settings.
- ST = Short Time; indicates a trip based upon the trip unit's Short Time Pickup and Short Time Delay settings.
- SC = Short Circuit; indicates a trip based upon the trip unit's Instantaneous setting.
- GF = Ground Fault; indicates a trip based upon the

trip unit's Ground Fault Pickup and Ground Fault Delay settings.

Max Log

The Max Log menu displays the maximum reading of the Phase Currents, Meter and Avg Amp Demand sub menus.

Clear Logs

The Clear Logs menu clears the present data in the Trip Log, Max Log, and Demand menus. To clear a log, press the MENU switch, otherwise press the DATA switch to go to the next sub menu.

Set Clock

The Set Clock menu adjusts the programmed date (day/month/year) and time (hour:minute). The hour setting is based on a 24 hour clock. To adjust the date/time press the MENU switch, otherwise press the DATA switch to go to the next sub menu.

3) LOW BATTERY

The battery voltage is automatically checked every time the display comes on and at midnight. When the battery voltage is too low, the display flashes BATTERY IS LOW every 10 seconds. If the display is not visible after pressing one of the input switches, replace battery immediately. Even though the display is not visible, the logged data will be maintained. Do not remove the battery from the unit until a new battery is ready to be installed.

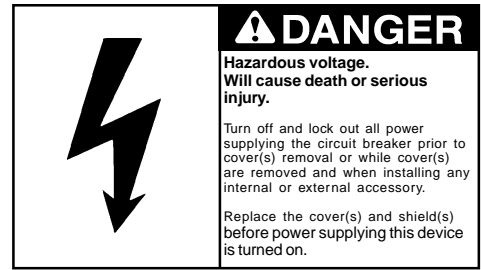

Installation Instructions

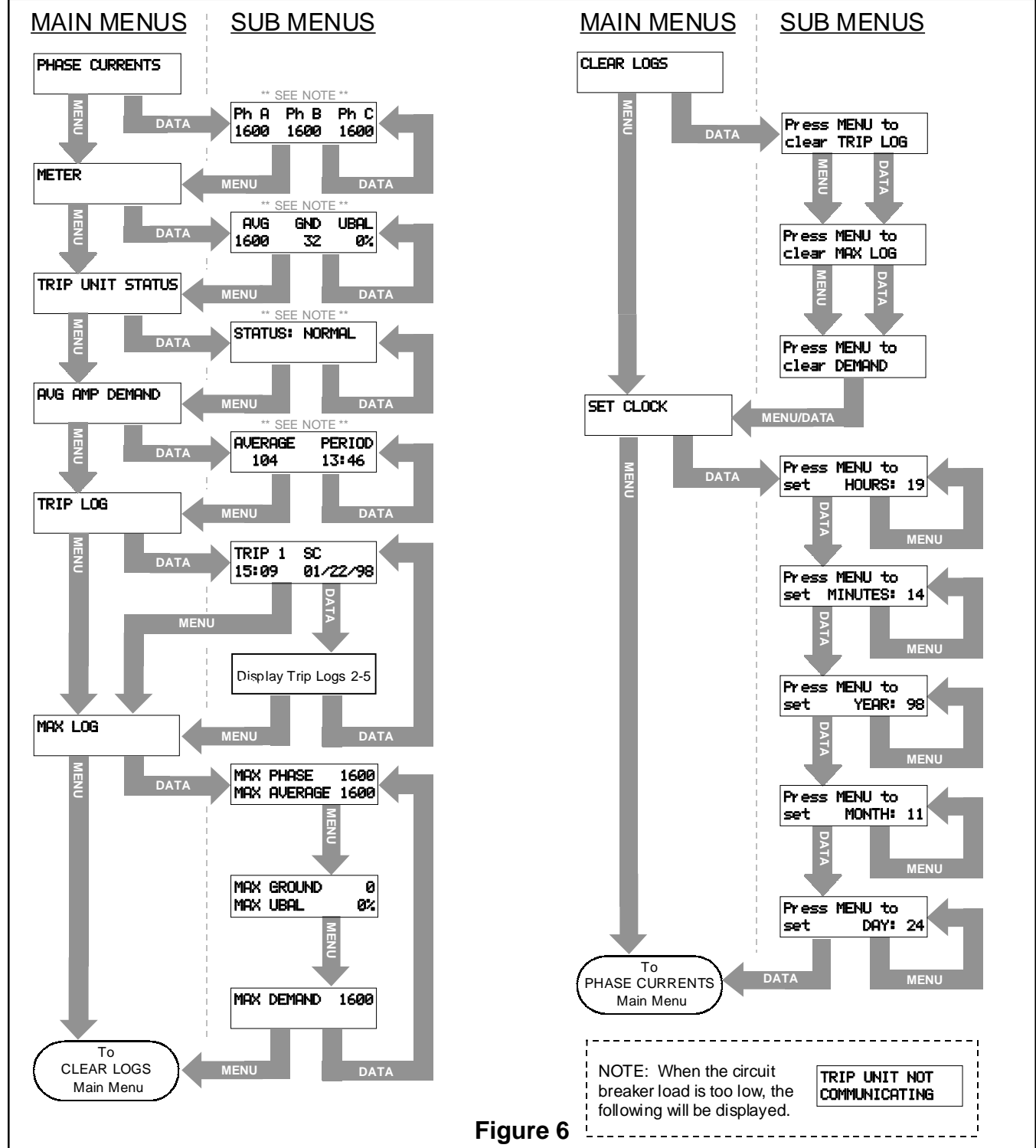

Figure 6