

Installation Instructions



⚠ DANGER

Hazardous voltage. Will cause death or severe injury.

Turn off and lock out all power before working on the circuit breaker.

Replace the covers and shields before power supplying the circuit breaker is restored.

⚠ SAFETY INSTRUCTIONS

APPLICATION INFORMATION			
No. Poles	Line End Adaptor	Load End Adaptor	Switchboard Mtg. Pan
2	PC5662	PC5662	PL9698
3	PC5663	PC5663	PL9698
3	PM5663	PM5663	PL9698

NOTE: This instruction sheet outlines the recommended installation procedure.

GENERAL

A complete plug-in installation requires one line end adaptor assembly (consisting of mounting block, tulip connectors, and associated hardware), one load end adaptor assembly and one switchboard mounting plate. The switchboard mounting plate is optional and can be replaced by other mounting means to suit customers' requirements.

MOUNTING PREPARATION: Figs. 1 & 2

1. Turn off and lock out all power supplying this device before installing or servicing.
2. If the switchboard mounting pan (1) is to be used, provide required drilling as shown in Fig. 1.
3. If other mounting means are to be used, provide the cutouts and drilling required to mount the adaptor blocks as shown in Fig. 2.

SWITCHBOARD MOUNTING PLATE (If Used): Fig. 3

4. Place switchboard mounting pan (1) in position at location previously prepared in Step 2 above. Secure in place with 5/16" [M8] hardware (hardware furnished by customer).

MOUNTING BLOCK: Fig. 3

5. Align mounting block (2) with cutouts in switchboard mounting plate (or customer's mounting means as previously prepared in Step 3 above) and secure in place with 3/8 flatwashers (3), lockwashers (4), and 3/8-16 hex nuts (5) furnished. Tighten to 216 In.-Lbs. (18 Ft.-Lbs.) [24.40 N/m].

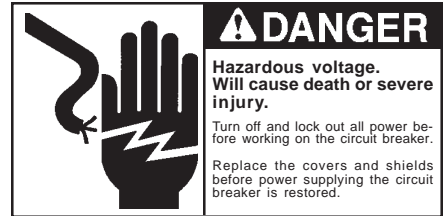

Installation Instructions

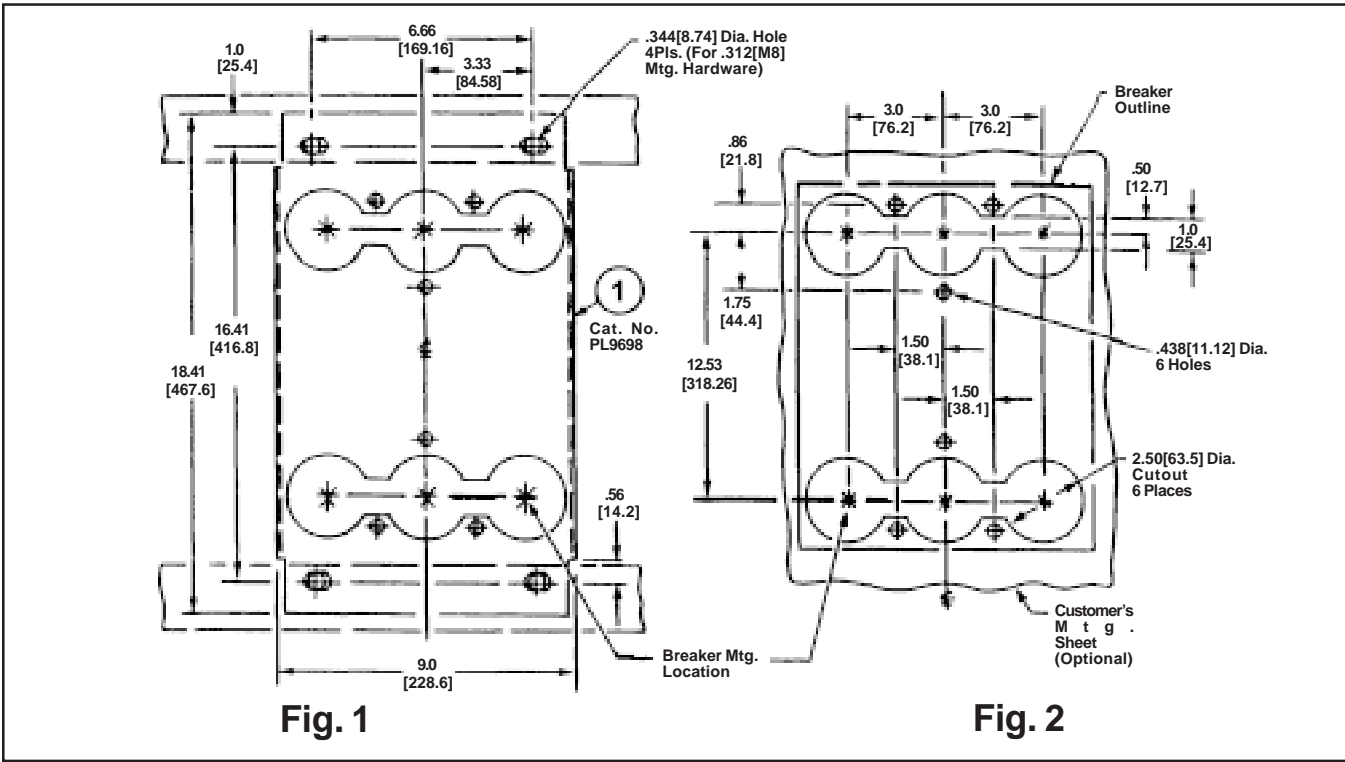

Dimensions
Inches [Millimeters]

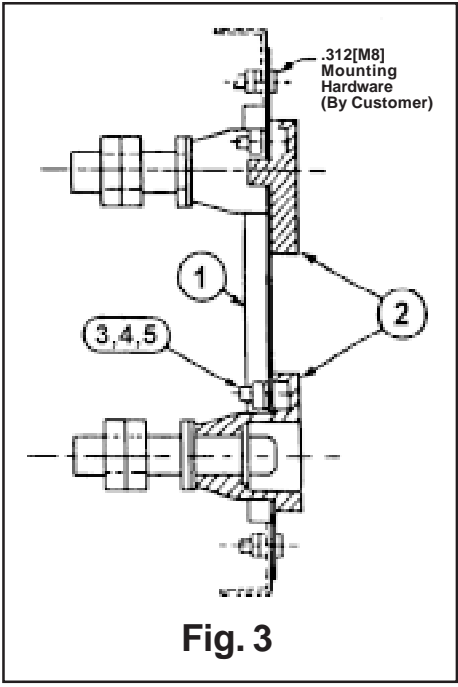

Fig. 3



Installation Instructions

BREAKER PREPARATION: Fig. 4

6. Loosen four breaker terminal shields screws (6) and remove both line and load side terminal shields (7).

CAUTION: Make certain that breaker operating handle is in the **OFF** or **TRIPPED** position before proceeding.

REMOVE PRESSURE WIRE CONNETORS FROM BREAKER IF PRESENT.

7. Place tulip clip assembly (8) on back of breaker in recess provided in base molding. Secure in place with 5/16-18 hex head bolts (11) furnished. Tighten these bolts to 72 In.-Lbs. (6 Ft.-Lbs.) [8.13 N/m] to assure a good electrical connection. Repeat this procedure for the remaining tulip clip assemblies.

8. **INSERT END SHIELDS (12) INTO SLOTS PROVIDED AT LINE AND LOAD END OF BREAKER.**

9. Affix label (13) to front of circuit breaker as shown in Fig. 4.

Dimensions
Inches [Millimeters]

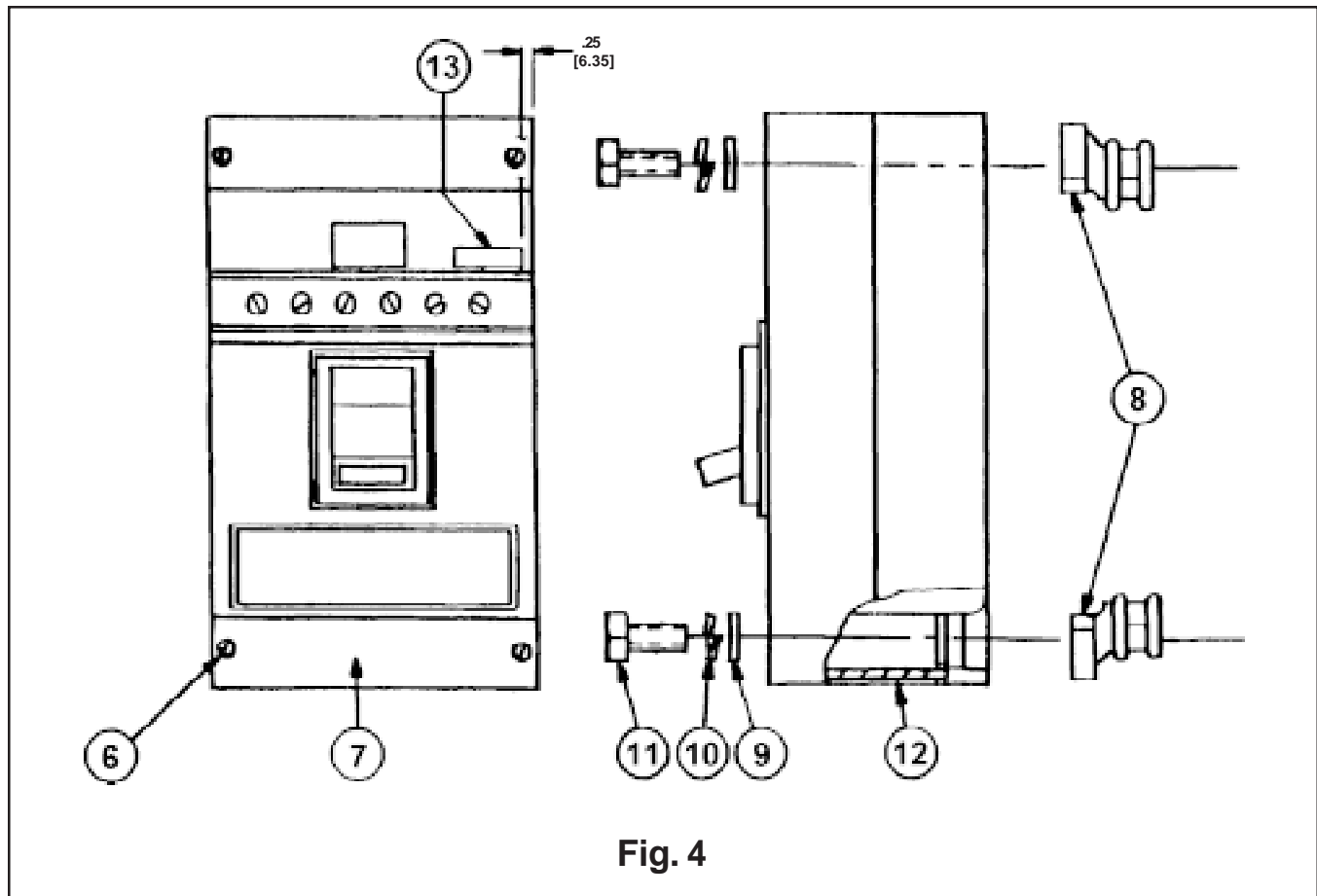
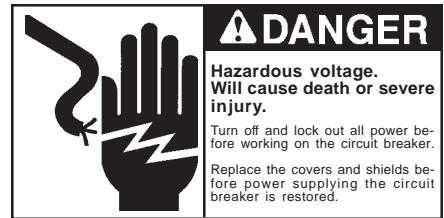

Fig. 4



Installation Instructions

FINAL ASSEMBLY : Fig. 5

10. Make bus connection to mounting block studs. **USE ONLY COPPER BUS BARS.** Use hex nuts (14) furnished to secure this connection. Tighten to 2400 In.-Lbs. (200 Ft.-Lbs.)[271.1 N/m].
11. Align breaker with mounting blocks and force female tulip clips over male studs in mounting block until breaker base bottoms against mounting block. Secure breaker in place with 3/8-16 x 1 1/2 mounting screws (15), lockwashers (16), and flatwashers (17) furnished. Tighten to 216 In.-Lbs. (18 Ft.-Lbs.)[24.40 N/m].
12. Replace breaker terminal shields (7) and secure with four breaker terminal shield screws (6). Tighten to 12 In.-Lbs. (1 Ft.-Lbs.)[1.36 N/m]
13. If installation requires use of front panel trim, provide cutout for breaker escutcheon as shown in Fig. 6.

Dimensions
Inches [Millimeters]

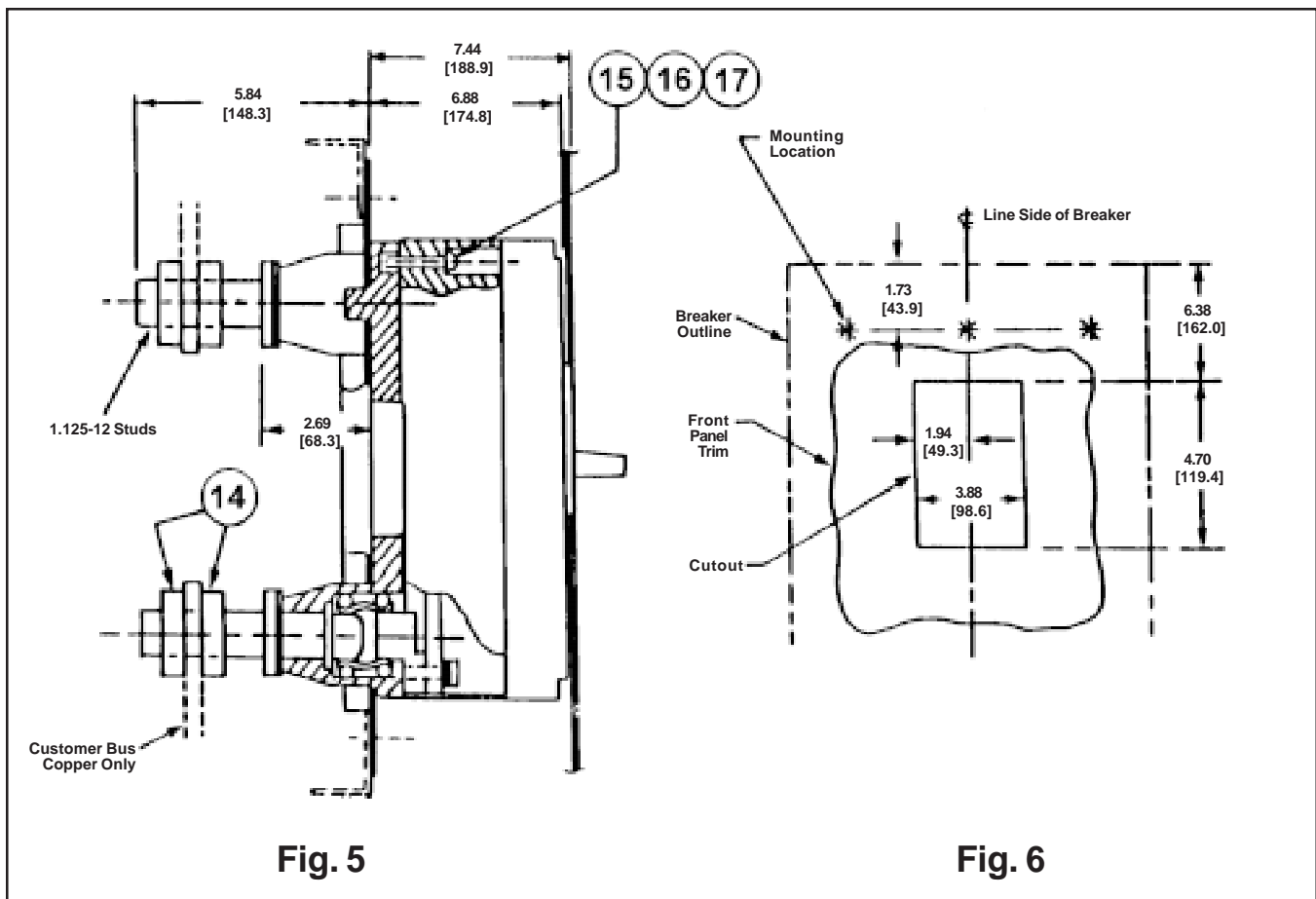

Fig. 5

Fig. 6