

## Installation Instructions



**⚠ DANGER**

**Hazardous voltage. Will cause death or severe injury.**

Turn off and lock out all power before working on the circuit breaker.

Replace the covers and shields before power supplying the circuit breaker is restored.

**⚠ SAFETY INSTRUCTIONS**

NOTE: This instruction sheet outlines the recommended installation procedure. The term Circuit Breaker, used in these instructions, includes motor circuit interrupters and molded case switches.

### GENERAL

These connecting straps can be used on 2 or 3 pole circuit breakers and on line and load terminals. Both the long straps RS5785 and the short straps RS5786, can be used on adjacent poles or alternated, as required by the installation.

### MOUNTING PREPARATION

1. Turn off and lock out all power supplying circuit breaker before installing.
2. Drill mounting panel as shown in drilling plan, Fig. 1. This user provided panel must be made from a material acceptable for supporting uninsulated live parts and have adequate strength to support the circuit breaker. Thickness 1/4 in. min., 1 in. max.

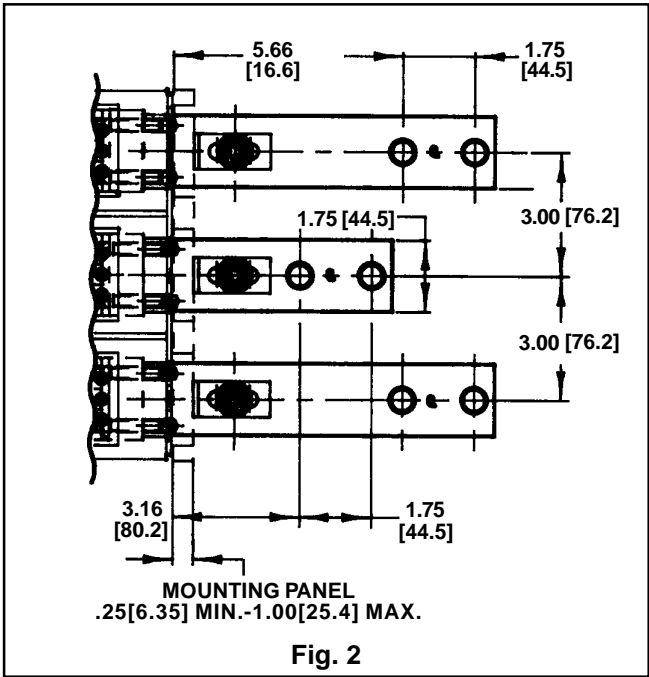
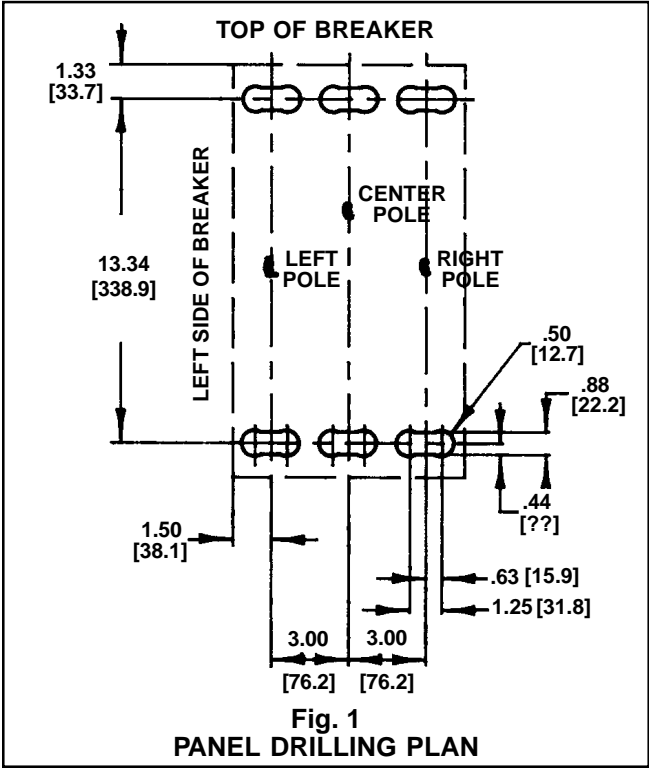

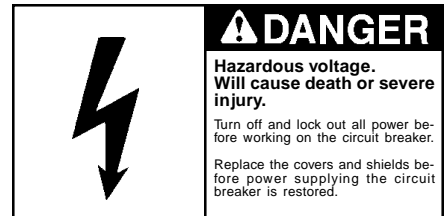

# Installation Instructions

3. Figures 1 and 2 show dimensioning information which can be used to plan the circuit breaker termination interface.

## CIRCUIT BREAKER PREPARATION:

1. Reference Figure 3. Remove terminal shield (1) from line and load side of breaker frame. Two 8-32 screws each (2).
2. Reference Figure 4. Attach the connecting straps (3) to each pole of the circuit breaker with two 5/16-18 hex head cap screws, flatwashers and lockwashers (4). Torque the screws to 72 In.-Lbs.[4.43 N/m].
3. Inspect the rear straps. When properly attached they should be aligned and parallel with each other and perpendicular with the circuit breaker mounting surface.

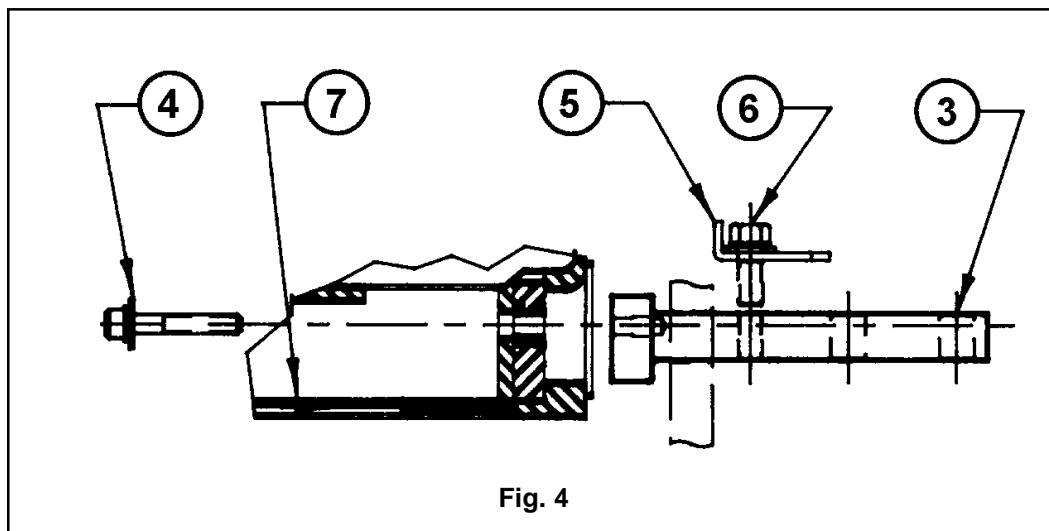
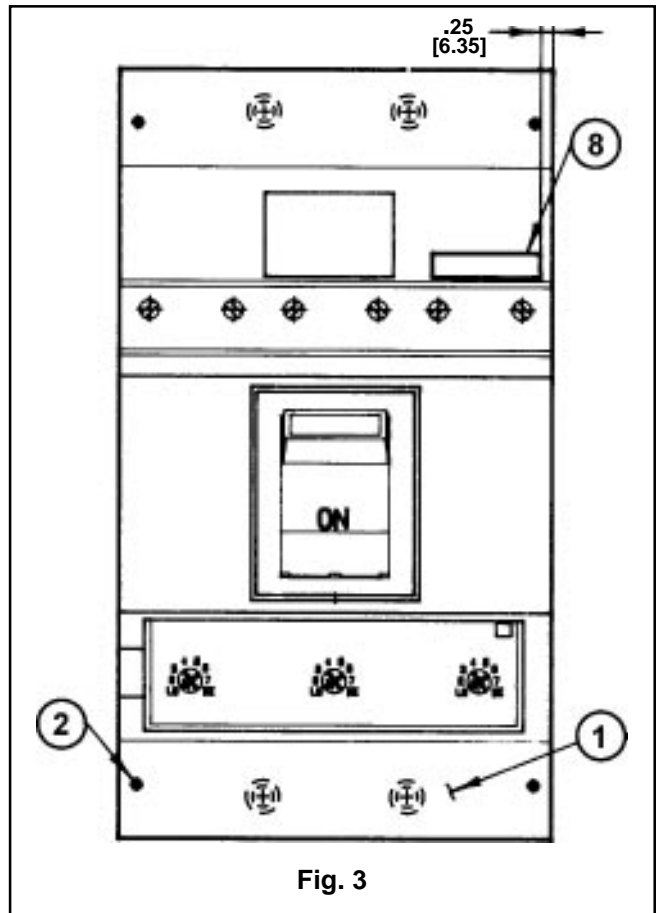



# Installation Instructions

## CIRCUIT BREAKER MOUNTING PROCEDURE

1. Position the circuit breaker on the mounting panel, passing the attached rear straps through the panel openings
2. Reference Figure 4. Secure the circuit breaker to the panel by attaching each connecting strap with the panel clamp (5), hex head bolt, lockwasher and flatwasher (6), supplied. Torque the bolts to 96 In.-Lbs.[5.90 N/m].
3. Complete the appropriate user connections to the rear connecting straps.
4. After the breaker is installed, attached to the mounting panel and terminated, retorque each of the 5/16-18 hex head cap screws. Figure 4, Item (4), to 72 In.-Lbs.[4.43 N/m].
5. Reference Figure 4. Insert the end shields (7) into the slots provided at the line and load ends of the breaker.
6. Reference Figure 3. Replace the breaker terminal shields (1) on the line and load side of the circuit breaker and secure with four breaker terminal shield screws (2). Tighten to 12 In.-Lbs.[0.74 N/m].
7. Affix label (This device is equipped with rear connecting studs) (8), to the front of the circuit breaker, as shown in Figure 3.
8. If installation requires use of front panel trim, provide cutout for breaker escutcheon as shown in Figure 5.

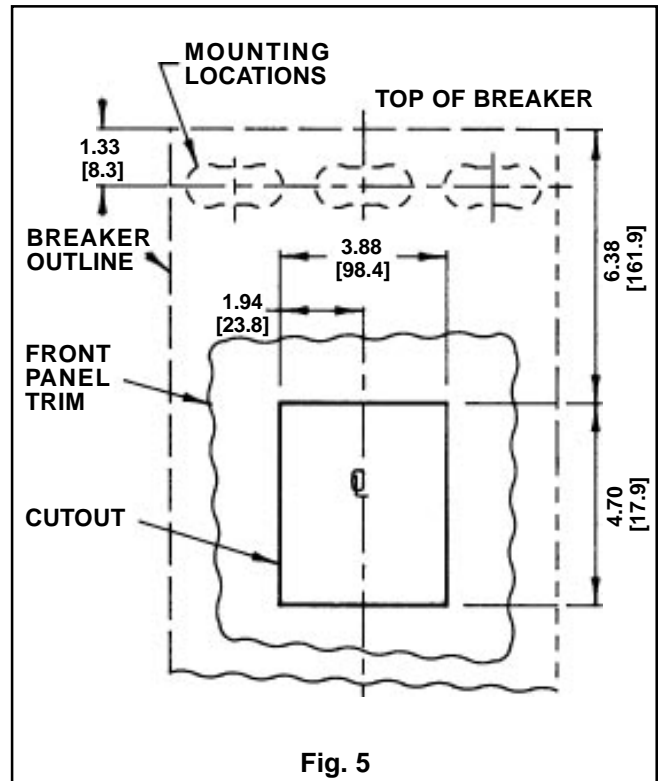

## INSTALLATIONS REQUIRING PANEL PREMOUNTED STUDS

If it is necessary to install the straps in a panelboard prior to their attachment to the circuit breaker, the following procedure is recommended.

1. Construct a strap positioning template fabricated from 1/2 inch thick material, dimensioned with the hole pattern shown in Figure 6.

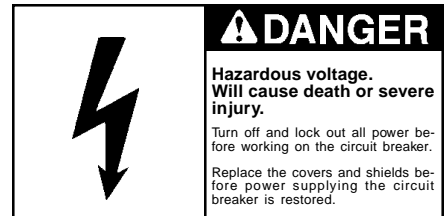

## Installation Instructions

2. Attach the rear connecting straps to the mounting template using the 5/16-18 hex head cap screws provided. Figure 4, Item (4). Note that the rear strap mounting pads are not symmetrical. The studs must be mounted with the orientation shown in Figure 4.
3. Position the template and stud assembly on the circuit breaker mounting panel, passing the attached rear straps through the panel opening.
4. Reference Figure 4. Secure the assembly to the panel by attaching each connecting strap with the panel clamp (5) hex head bolt, lockwasher and flat washer (6) supplied. Torque to 96 In.-Lbs.[5.90 N/m].
5. Complete the appropriate user connections to the rear connecting straps.
6. Remove the positioning template.
7. Mount the circuit breaker by positioning it over the rear strap mounting pads. Attach each pole (Line and Load) of the circuit breaker to the connecting straps with the two 5/16-18 hex head cap screws, flatwashers and lockwashers, Figure 4, Item (4). Torque each screw to 72 In.-Lbs.[4.43 N/m].
8. Reference Figure 4. Insert the end shields (7) into the slots provided at the line and load ends of the breaker.
9. Reference Figure 3. Replace the breaker terminal shields, (1) on the load and line side of the circuit breaker and secure with four breaker terminal shield screws (2). Tighten to 12 In.-Lbs.[0.74 N/m].

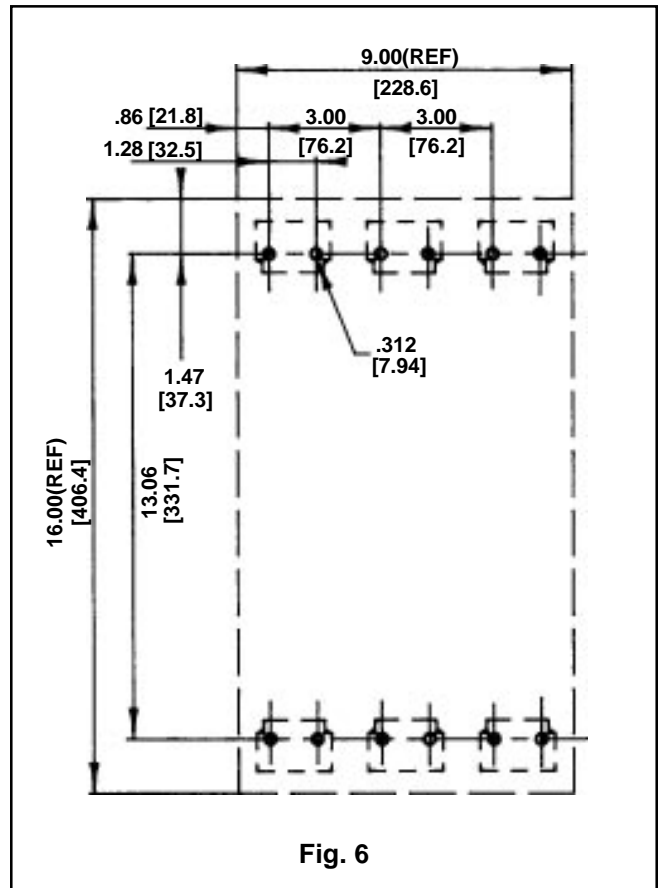

10. Affix label (This device is equipped with rear connecting studs (8), to the front of the circuit breaker, as shown in Figure 3.