

# SIEMENS

Motor Circuit Protector, Frame JG, LG  
 Protector Del Circuito Del Motor, Caja Base JG, LG  
 Protecteur De Circuit De Moteur, de Base JG, LG

	U.S. Cat. No.	Euro Order No.
Item:	HJM3M400	3VL4140-2KK30-0AA0
	HJM3L400	3VL4140-2KJ30-0AA0
	HLM3L600	3VL4860-2KJ30-0AA0
	HLM3M600	3VL4860-2KK30-0AA0

Installation Instructions / Instructivo de Instalación

	 <b>Danger</b>	 <b>Peligro</b>	 <b>Danger</b>
	<b>Hazardous Voltage.</b> <b>Will cause death or serious injury.</b> Turn off and lock out all power supplying this device before working on this device. Replace all covers before power supplying this device is turned on.	<b>Tensión peligrosa.</b> <b>Puede causar la muerte o lesiones graves.</b> Desenergice totalmente antes de instalar o darle servicio. Reemplace todas las barreras y cubiertas antes de energizar el interruptor.	<b>Tension dangereuse.</b> <b>Danger de mort ou risque de blessures graves.</b> Couper l'alimentation de l'appareil et barrer avant de travailler. Remplacez tous les couverts avant que l'alimentation de pouvoir soit alimenté.

Use only with Siemens certified Components.  
 Utilizar únicamente con componentes certificados de Siemens.  
 A utiliser uniquement avec les composants certifiés Siemens.

NOTE - These instructions do not purport to cover all details or variations in equipment, or to provide for every possible contingency to be met in connection with installation, operation or maintenance. Should further information be desired or should particular problems arise, which are not covered sufficiently for the purchaser's purposes, the matter should be referred to the local Siemens sales office. The contents of this instruction manual shall not become part of or modify any prior or existing agreement, commitment or relationship. The sales contract contains the entire obligation of Siemens. The warranty contained in the contract between the parties is the sole warranty of Siemens. Any statements contained herein do not create new warranties or modify the existing warranty.

Trademarks - Unless otherwise noted, all names identified by ® are registered trademarks of Siemens AG or Siemens Industry, Inc. The remaining trademarks in this publication may be trademarks whose use by third parties for their own purposes could violate the rights of the owner.

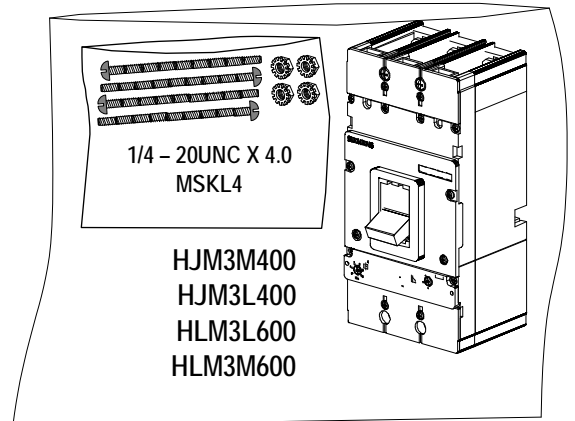
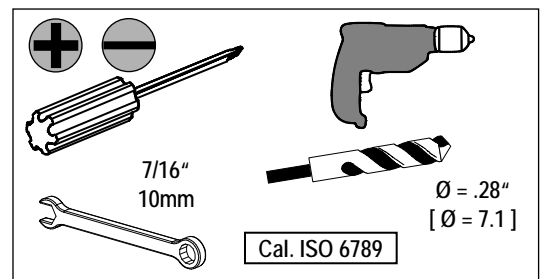

1

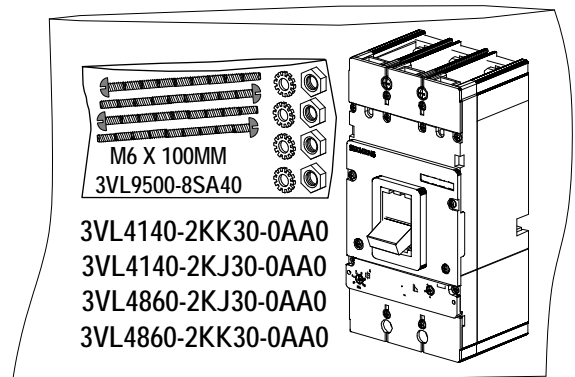
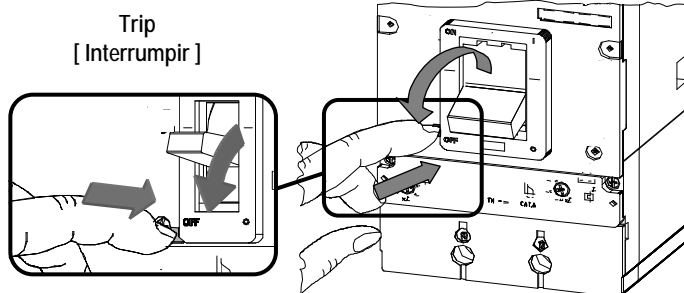

2

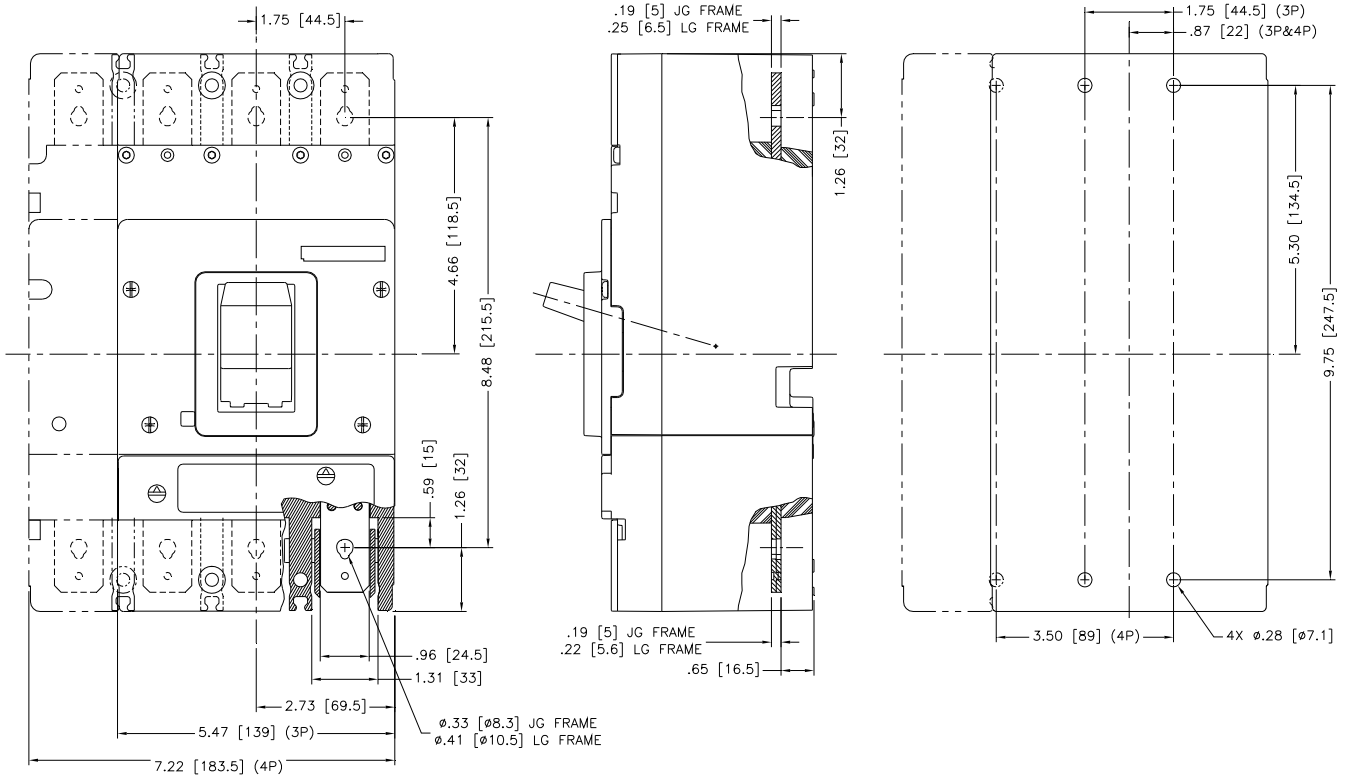

3

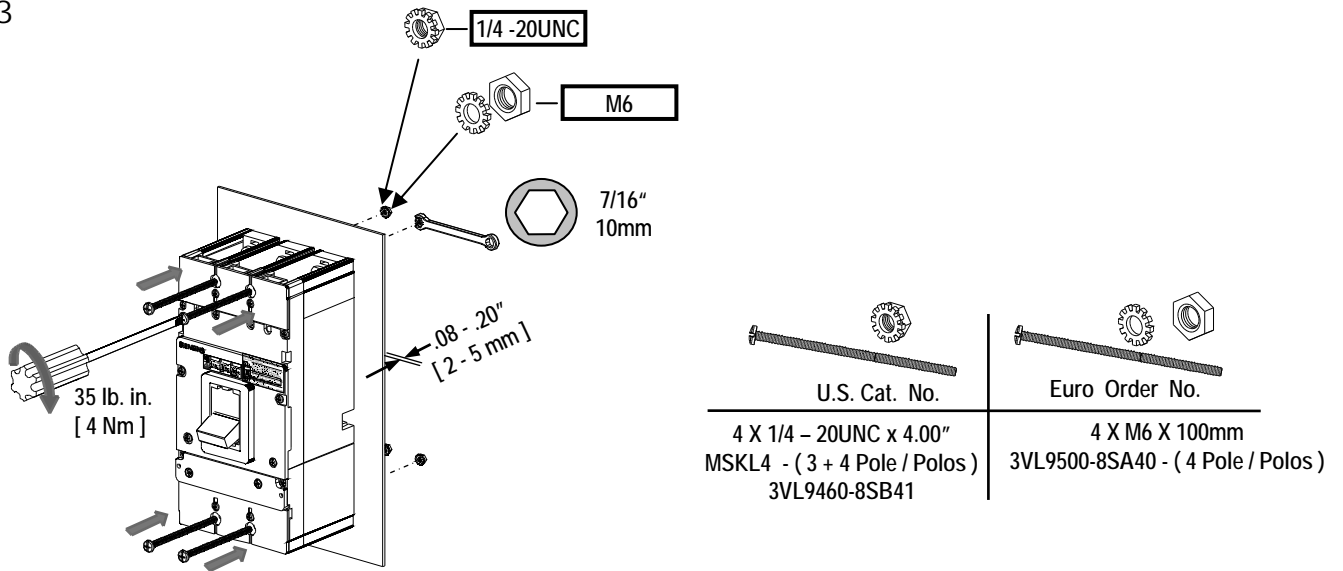

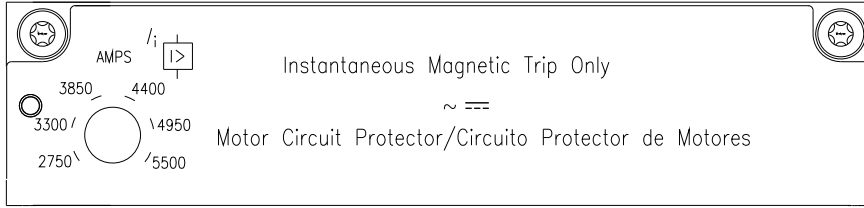

JG / LG

EX: HLM3M600  
[ 3VL4860-2KK30-0AA0 ]

VL Motor Circuit Protector ( MCP )		
Motor Full Load Amps	Trip Switch Setting ( A )	Catalog Number
96 - 139	1250	<b>HJM3L400</b> [ 3VL4140-2KJ30-0AA0 ] 400 Amp
115 - 167	1500	
135 - 194	1750	
154 - 222	2000	
173 - 250	2250	
192 - 278	2500	
154 - 222	2000	<b>HJM3M400</b> [ 3VL4140-2KK30-0AA0 ] 400 Amp
185 - 267	2400	
215 - 311	2800	
246 - 356	3200	
277 - 400	3600	
( 308 - 400 ) See Footnote ①	4000	
154 - 222	2000	<b>HLM3L600</b> [ 3VL4860-2KJ30-0AA0 ] 600 Amp
185 - 267	2400	
215 - 311	2800	
246 - 356	3200	
277 - 400	3600	
308 - 444	4000	
212 - 306	2750	<b>HLM3M600</b> [ 3VL4860-2KK30-0AA0 ] 600 Amp
254 - 367	3300	
296 - 428	3850	
338 - 489	4400	
381 - 550	4950	
423 - 600	5500	

① -These settings are provided for starting currents greater than 11X but not to exceed 17X. Full Load Amps ( FLA ) not to exceed ampere rating of MCP.

Bestell-Nr. / Order No.: 3ZX1012-0VL68-3BA1      Internet: [www.siemens.de/lowvoltage/technical-assistance](http://www.siemens.de/lowvoltage/technical-assistance)      GWA 4NEB 179 6954-10 DS 04

Technical Support:      Toll Free: 1-800-241-4453      Internet: [www.usa.siemens.com/powerdistribution](http://www.usa.siemens.com/powerdistribution)