

SIEMENS

Indoor/Outdoor Service Entrance Module

Catalog Number
WS1600CU

Enclosure
Type 3R

Module Rating:

600 Amps, Max; See fuse for actual rating.
120/240 Volts~, 60 HZ, 1 Phase, 3 Wire
208Y/120 Volts~, 60 HZ, 1 Phase, 3 Wire (from 3 Phase, 4 Wire network)

For installation by Qualified Person in accordance with all local electrical codes and/or the National Electrical Code®.

Suitable Only For Use As Service Equipment unless bond strap is removed. See schematic. Apply appropriate label provided next to switch handle.

Enclosure may be oriented for Overhead or Underground Service.

Use 75°C Copper or Aluminum Conductors.

Connect Modules Using:	Cat. No.	Torque
Single Bolt Joint	SBJ1	400-480 lb-in (35-40 ft.-lb.)
Quick Connect	QC1	400-440 lb-in (35-36 ft.-lb.)

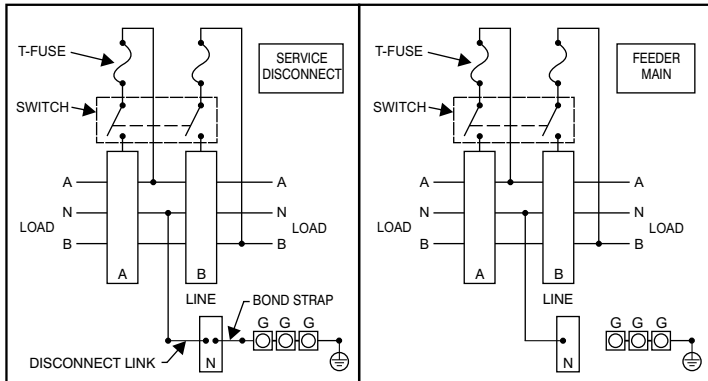

See adjacent label for additional marking information.

49311255

Siemens Industry, Inc. Norcross, Georgia U.S.A.

D

4090005010101 Rev.B

© The National Electrical Code is a registered trademark of the National Fire Protection Association.
© 2009 Copyright Siemens Industry, Inc.

SIEMENS

If cover interlock is defeated, it will be necessary for cover interlock plate to be positioned over opening and retightened.

This device has a maximum short circuit current rating of 100,000 amps RMS symmetrical at 240 Volts~. Use Class T (300V) fuses only. Continuous load current not to exceed 80% of the rating of the fuses in other than motor circuits.

Lugs for Phase and Neutral Connections (not supplied)					
NEMA Lug ^①	MFG	Wire Range	Type	No. Wires per phase	Torque (lb.-in.)
LK12500N2	Siemens	1/0-500 kcmil	Mechanical	2	500
2ACL-500	ILSCO	500 kcmil	Compression	2	NA ^②

- ① Order one mechanical lug kit for main breaker and neutral conversions. Contact lug manufacturer for compression lug quantities supplied for each kit.
- ② See lug manufacturer's instruction sheet supplied with the connector for tool, die, and number of crimps.

Ground terminal G:
Wire size #4-300 kcmil
Torque terminal to 250 lb.-in.

Torque fuse mounting hardware to 225 lb-in.

Use HD Type Hubs if required	
Trade Size (in)	Catalog No.
2"	EC56854
2-1/2"	EC56855
3"	EC56856
3-1/2"	EC56857
4"	EC56858
Closure Plate	EC56933S

IMPORTANT - for use with:

Module	Siemens Series#	Murray Series#
Main Breakers	(W)MC, WB, WEB	DB_W
Switches	WMP, WMS, WS, WES	DPT_W, DT_W
Tap/Terminal Boxes	WMTB, WTB, WET	DTB_W
Pull Boxes	WMMB, WPB, WAPB	DPB_W
Meter Module	WMM, WxMM, WMT, WML, WMK	DG_W, DC_W, DL_W
Extension Box	WMEX, WSP	DS
Bussed Elbow	(W)BE	DL

Important: Do not allow petroleum based (hydrocarbon) sprays, chemicals, solvents or any paint to contact interior components. Petroleum based chemicals can cause degradation of electrical insulating materials.

49311256

Siemens Industry, Inc. Norcross, Georgia U.S.A.

D

4090005010201 Rev.B

© 2009 Copyright Siemens Industry, Inc.