

# VL Circuit Breaker – NG 1200A frame



## Breaker type

Defined by the 3rd character of the catalog number

- G – Global (UL, CSA, NOM, IEC, CE), interchangeable
- X – Global, non-interchangeable
- Y – Global, 100% rated, non-interchangeable

## Trip unit type

Defined by the 5th character of the catalog number

- B – Thermal-magnetic, model 525
- N – LI, electronic, model 545
- P – LSI, electronic, model 545
- X – LIG, electronic, model 545
- U – LSIG, electronic, model 545
- D – LSI, electronic with LCD, model 576
- E – LSIG, electronic with LCD, model 576
- R – LI, electronic, Model 555
- T – LSI, electronic, Model 555
- W – LIG, electronic, Model 555
- V – LSIG, electronic, Model 555
- A – LSI, electronic with LCD, Model 586
- G – LSIG, electronic with LCD, Model 586
- K – LSI + GF alarm, electronic with LCD, Model 586

For DC applications, use thermal magnetic trip unit only.  
For reverse-feed applications, select non-interchangeable trip breakers only.  
HACR rated.

## Interrupting ratings

Interrupting Class	Breaker Type	RMS symmetrical amperes (kA)								
		UL 489			IEC 60947-2			UL or IEC		
		Volts AC			Volts AC			Volts DC <sup>①</sup>		
		240	480	600	240	415	690	250	500	600 <sup>②</sup>
N	NNG	65	35	25	65 / 35	50 / 25	20 / 10	22	35	–
H	HNG	100	65	35	100 / 50	70 / 35	30 / 15	25	50	65
L	LNG	200	100	65	200 / 100	100 / 50	35 / 17	42	65	–

UL / CSA / NOM 40°C 50/60Hz IEC 40°C 50/60Hz

① For DC applications and wiring diagrams, see p. 5 of VL Information Guide.  
② Special version, Type HNGD. See Speedfax catalog for more information.

## Trip Unit Model 525

### Thermal magnetic trip units, model 525

$I_n$ – Trip unit rating (amps)	$I_i$ – Nominal instantaneous trip adjustable range (amps)					
800	4000	4800	5600	6400	7200	8000
900	5000	6000	7000	8000	9000	10000
1000	5000	6000	7000	8000	9000	10000
1200	7000	8000	9000	10000	11000	12000

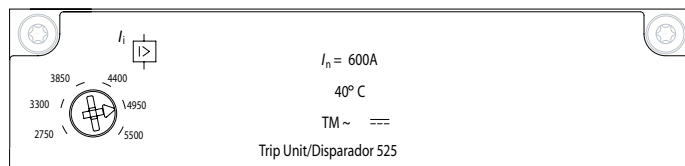

Trip unit model 525

## Trip Unit Model 545

### Electronic trip units, Model 545 with LI (Trip unit type N) or LIG (Trip unit type X) Trip Functions

Switch 1	$I_n$ – Trip unit rating (amps)	$I_r$ – Continuous amp switch settings (amps)										
		800	300	300	315	350	400	500	600	630	700	800
	1000	400	400	400	500	600	630	700	800	900	1000	
	1200	400	400	500	600	630	700	800	900	1000	1200	
Switch 2	$I_n$ – Trip unit rating (amps)	$t_r$ – Long time delay switch settings (seconds) Pt @ 6 x $I_r$										
		800, 1000, 1200	2.5	4	6	8	10	14	17	20	25	30
Switch 3	$I_n$ – Trip unit rating (amps)	$I_i$ – Nominal instantaneous trip switch settings (amps)										
		800	1000	1200	1600	2400	3200	4000	4800	6400	8000	8800
		1000	1205	1500	2000	3000	4000	5000	6000	8000	10000	11000
		1200	1500	1800	2400	3600	4800	6000	7200	9600	12000	12000

## Fixed settings (LIG only)

$I_n$ – Trip unit rating (amps)	$I_g$ – Ground fault pickup (amps)	$t_g$ – Ground fault delay
800	480	.25 sec
1000	600	.32 sec
1200	720	.32 sec

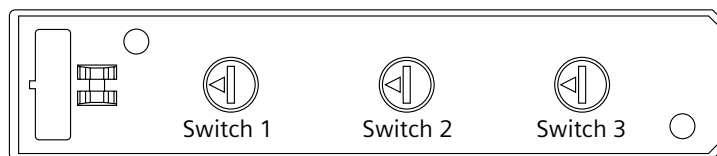

Trip unit model 545

### Trip Unit Model 545 (continued)

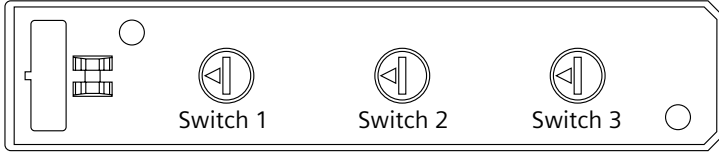

#### Electronic trip units, Model 545 with LSI (Trip unit type P) or LSIG (Trip unit type U) Trip Functions

Switch 1	$I_n$ – Trip unit rating (amps)	$I_r$ – Continuous amp switch settings (amps)										
	800	300	300	315	350	400	500	600	630	700	800	
	1000	400	400	400	500	600	630	700	800	900	1000	
	1200	400	400	500	600	630	700	800	900	1000	1200	
Switch 2	$I_n$ – Trip unit rating (amps)	$I_{sd}$ – Short time pick-up switch settings (amps) x $I_r$										
	800, 1000, 1200	1.5	2	2.5	3	4	5	6	7	8	10	
Switch 3	$I_n$ – Trip unit rating (amps)	$t_{sd}$ – Short time delay switch settings (seconds) @ $8xI_r$										
	800, 1000, 1200	0	0.1, $I^2t$ OFF	0.2, $I^2t$ OFF	0.3, $I^2t$ OFF	0.4, $I^2t$ OFF	0.5, $I^2t$ OFF	0.1, $I^2t$ ON	0.2, $I^2t$ ON	0.3, $I^2t$ ON	0.4, $I^2t$ ON	

#### Fixed settings

$I_n$ – Trip unit rating (amps)	$t_r$ – Long time delay	$I_i$ – Nominal instantaneous trip	$I_g$ – Ground fault pick-up (LSIG only)	$t_g$ – Ground fault delay (LSIG only)
800		8000A	480A	.25 sec.
1000	10 sec. ( $I^2t$ @ $6 \times I_r$ )	10000A	600A	.32 sec
1200		12000A	720A	.32 sec

### Trip Unit Model 555

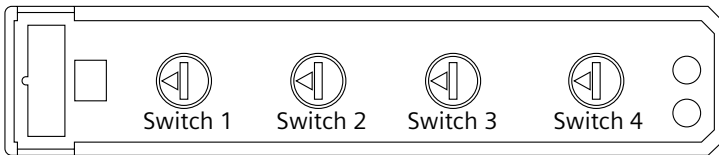

#### Electronic trip units, Model 555 with LI (Trip unit type R) or LIG (Trip unit type W) Trip Functions

Switch 1	$I_n$ – Trip unit rating (amps)	$I_r$ – Continuous amp switch settings (amps)										
	800	300	315	350	400	450	500	600	630	700	800	
	1000	400	450	500	550	600	630	700	800	900	1000	
	1200	400	450	500	600	630	700	800	900	1000	1200	
Switch 2	$I_n$ – Trip unit rating (amps)	$t_r$ – Long time delay switch settings (seconds) $I^2t$ @ $6 \times I_r$										
	800, 1000, 1200	2.5	4	6	8	10	14	17	20	25	30	
Switch 3	$I_n$ – Trip unit rating (amps)	$I_i$ – Nominal instantaneous trip switch settings (amps)										
	800	1000	1200	1600	2400	3200	4000	4800	6400	8000	8800	
	1000	1250	1500	2000	3000	4000	5000	6000	8000	10000	11000	
	1200	1500	1800	2400	3600	4800	6000	7200	9600	12000	12000	
Switch 4 (LIG Only)	$I_n$ – Trip unit rating (amps)	$I_g$ – Ground fault pick-up switch settings (amps)										
	800	480	320	320	320	480	480	480	800	800	800	
	1000	600	400	400	400	600	600	600	1000	1000	1000	
	1200	720	480	480	480	720	720	720	1200	1200	1200	
Switch 4 (LIG Only)	$I_n$ – Trip unit rating (amps)	$t_g$ – Ground fault delay switch settings (seconds)										
	800	0.25	0.10	0.20	0.30	0.10	0.20	0.30	0.10	0.20	0.30	
	1000, 1200	0.32	0.10	0.20	0.30	0.10	0.20	0.30	0.10	0.20	0.30	

## Trip Unit Model 555 (continued)

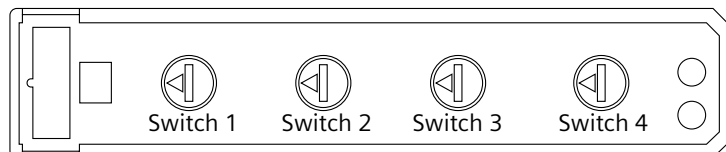

### Electronic trip unit, Model 555 with LSI (Trip unit type T) Trip Functions

Switch 1	$I_n$ – Trip unit rating (amps)	$I_r$ – Continuous amp switch settings (amps)										
	800	400	500	600	700	800	400	500	600	700	800	
	1000	600	700	800	900	1000	600	700	800	900	1000	
Switch 1	$I_n$ – Trip unit rating (amps)	$t_r$ – Long time delay switch settings (seconds) $I^2t @ 6 \times I_r$										
	800, 1000, 1200	10	10	10	10	10	20	20	20	20	20	
Switch 2	$I_n$ – Trip unit rating (amps)	$I_{sd}$ – Short time pick-up switch settings (amps) $\times I_r$										
	800, 1000, 1200	1.5	2	2.5	3	4	5	6	7	8	10	
Switch 3	$I_n$ – Trip unit rating (amps)	$t_{sd}$ – Short time delay switch settings (seconds)										
	800, 1000, 1200	0	0.1, $I^2t$ OFF	0.2, $I^2t$ OFF	0.3, $I^2t$ OFF	0.4, $I^2t$ OFF	0.5, $I^2t$ OFF	0.1, $I^2t$ ON	0.2, $I^2t$ ON	0.3, $I^2t$ ON	0.4, $I^2t$ ON	
Switch 4	$I_n$ – Trip unit rating (amps)	$I_i$ – Nominal instantaneous trip switch settings (amps)										
	800	1000	1200	1600	2400	3200	4000	4800	6400	8000	8800	
	1000	1250	1500	2000	3000	4000	5000	6000	8000	10000	11000	
	1200	1500	1800	2400	3600	4800	6000	7200	9600	12000	12000	

### Electronic trip unit, Model 555 with LSIG (Trip unit type V) Trip Functions

Switch 1	$I_n$ – Trip unit rating (amps)	$I_r$ – Continuous amp switch settings (amps)										
	800	400	500	600	700	800	400	500	600	700	800	
	1000	600	700	800	900	1000	600	700	800	900	1000	
Switch 1	$I_n$ – Trip unit rating (amps)	$t_r$ – Long time delay switch settings (seconds) $I^2t @ 6 \times I_r$										
	800, 1000, 1200	10	10	10	10	10	20	20	20	20	20	
Switch 2	$I_n$ – Trip unit rating (amps)	$I_{sd}$ – Short time pick-up switch settings (amps) $\times I_r$										
	800, 1000, 1200	1.5	2	2.5	3	4	5	6	7	8	10	
	$I_n$ – Trip unit rating (amps)	$I_i$ – Nominal instantaneous trip switch settings (amps) $\times I_n$										
Switch 2	800, 1000	5	5	5	5	5	11	11	11	11	11	
	1200	5	5	5	5	5	10	10	10	10	10	
Switch 3	$I_n$ – Trip unit rating (amps)	$t_{sd}$ – Short time delay switch settings (seconds)										
	800, 1000, 1200	0	0.1, $I^2t$ OFF	0.2, $I^2t$ OFF	0.3, $I^2t$ OFF	0.4, $I^2t$ OFF	0.5, $I^2t$ OFF	0.1, $I^2t$ ON	0.2, $I^2t$ ON	0.3, $I^2t$ ON	0.4, $I^2t$ ON	
Switch 4	$I_n$ – Trip unit rating (amps)	$I_g$ – Ground fault pick-up switch settings (amps)										
	800	480	320	320	320	480	480	480	800	800	800	
	1000	600	400	400	400	600	600	600	1000	1000	1000	
Switch 4	$I_n$ – Trip unit rating (amps)	$t_g$ – Ground fault delay switch settings (seconds)										
	800	0.25	0.10	0.20	0.30	0.10	0.20	0.30	0.10	0.20	0.30	
	1000, 1200	0.32	0.10	0.20	0.30	0.10	0.20	0.30	0.10	0.20	0.30	

## Trip Unit Model 576 and 586

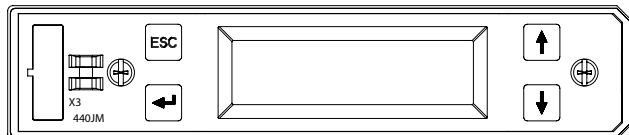

Trip unit model 576

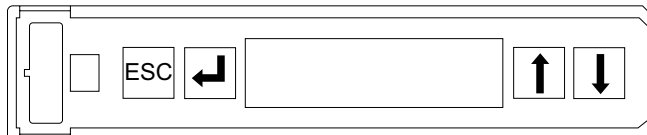

Trip unit model 586

### Electronic trip units with LCD Model 576 (Trip unit type D and E) or Model 586 (Trip unit type A, G and K)

$I_n$ – Trip unit rating (amps)	$I_r$ – Continuous amps range <sup>①</sup>	$t_r$ – Long time delay settings ( $I^2t @ 6 \times I_r$ )	$I_{sd}$ – Short time pick-up range	$t_{sd}$ – Short time delay settings	$I_i$ – Nominal instantaneous trip range <sup>①②</sup>
800	300 - 800	2.5, 4, 6, 8, 10, 14,	1.25 - $10 \times I_r$ (8,000 A max.)	0.1, 0.2, 0.3, 0.4, 0.5 sec.	1000 - 8800A
1000	400 - 1000	17, 20, 25, 30 sec.	1.25 - $10 \times I_r$ (10,000 A max.)	( $I^2t$ off) or $I^2t @ 8 \times I_r$ ( $I^2t$ on)	1250 - 11000A
1200	400 - 1200		1.25 - $10 \times I_r$ (10,800 A max.)		1500 - 12000A

$I_n$ – Trip unit rating (amps)	$I_g$ – Ground fault pick-up range <sup>①</sup>	$t_g$ – Ground fault delay	Pre-alarm indication
800	320 - 800A	0.1, 0.2, 0.3, 0.4, 0.5 sec. ( $I^2t$ off) or $I^2t @ .5 \times I_n$ ( $I^2t$ on)	80 - 100% $\times I_r$ (Amps)
1000	400 - 1000A		
1200	480 - 1200A		

① Current settings are adjustable in 1-amp increments.

② Model 586, can turn function OFF. Instantaneous trip override function will be enabled to ensure self protection of circuit breaker.

### Motor circuit protectors

Amp rating	$I_i$ – Nominal instantaneous trip adjustable range (amps) <sup>①</sup>
1200	7000 – 12000

① Settings adjustable in increments of 1000 amps.

### Molded case switch

Amp rating	Self-protective instantaneous override	Short-circuit current rating 480 V AC <sup>①</sup>
1200	12000A	65 kA
1200	12000A	100 kA

① Max. available current when protected by an appropriate overcurrent protective device.

### 600 V DC circuit breakers

Amp rating	Short-circuit rating 600 V DC
800, 900, 1000, 1200	65 kA

## Terminal Connectors

Wire range	Cables per connectors	Wire size	Torque lb-in. (Nm)	Catalog number
1/0 – 500 kcmil	4 (Cu / Al)	1/0 - 500	375 (42.37)	3TA4NG500 ①②
500 – 750 kcmil	3 (Cu / Au)	500 - 750	375 (42.37)	3TA3NG750 ②
1/0 – 500 kcmil	4 (Cu / Al)	1/0 - 500	375 (42.37)	3TA4NG500H ②③
1/0 – 500 kcmil	4 (Cu / Al)	1/0 - 500	375 (42.37)	3TC4NG500 ②③

## Compression connector kits

1/0 - 500 kcmil	4 (Cu / Al)		12CLN500 ④
-----------------	-------------	--	------------

① Standard connector when an "L" suffix is used on an assembled breaker catalog number.

② Packaged as 3 connectors.

③ For 100% rated NG applications. Requires 90°C cable sized at 75°C ampacity.

④ Packaged as 12 connectors (4 connectors per phrase).

## Internal accessories

Auxiliary and alarm switch kits		
Description	Mounting pocket	Catalog number
2 Aux + 2 Alarm switches (2NO + 2NC + 1 base)	Left	ASKP3
4 Aux. switches (2NO + 2NC + 1 base)	Left, right	ASKP4

Auxiliary and alarm switch mounting base only		
Description	Mounting pocket	Catalog number
For 2 Aux + 2 Alarm	Left	AMBP2
For 4 Aux	Left, right	AMBP1

Shunt trip	
Control voltage	Catalog number
48 – 60 VAC	STRPM60
110 – 127 VAC	STRPN120
208 – 277 VAC	STRPS277
380 – 600 VAC	STRPV600
24 VDC	STRPB24DC
48 – 60 VDC	STRPC60DC
110 – 127 VDC	STRPD125DC
220 – 250 VDC	STRPE250DC

Shunt trips or UVR's may be mounted in the Right Pocket only.

Internal accessory locations	
Left accessory pocket	Right accessory pocket
Up to 4 auxiliary switches ①	Shunt trip or UVR or up to 4 auxiliary switches ①
Up to 2 auxiliary switches ② + 2 alarm switches	Shunt trip or UVR or up to 4 auxiliary switches ①

Maximum of 8 switches total.

Maximum of 2 alarm switches, Left Pocket only.

Maximum of 4 switches in Left Pocket.

① Max load is 5A per switch when 4 switches are mounted.

② Max load is 10A per switch.

Auxiliary / Alarm switches only (requires a base)	
Description	Catalog number
1 NO (normally open contact)	ASWPA
1 NC (normally closed contact)	ASWPB

(A) Normally open contacts are open when the breaker contacts are open.

(B) Normally closed contacts are closed when the breaker contacts are open.

Undervoltage release	
Control voltage	Catalog number
110 – 127 VAC	UVRPN120
220 – 250 VAC	UVRPR240
208 VAC	UVRPP208
277 VAC	UVRPS277
380 – 425 VAC	UVRPT415
440 – 480 VAC	UVRPU480
12 VDC	UVRPA12DC
24 VDC	UVRPB24DC
48 VDC	UVRPC48DC
60 VDC	UVRPG60DC
110 – 127 VDC	UVRPD125DC
220 – 250 VDC	UVRPE250DC

## Dimensions

(complete breaker)

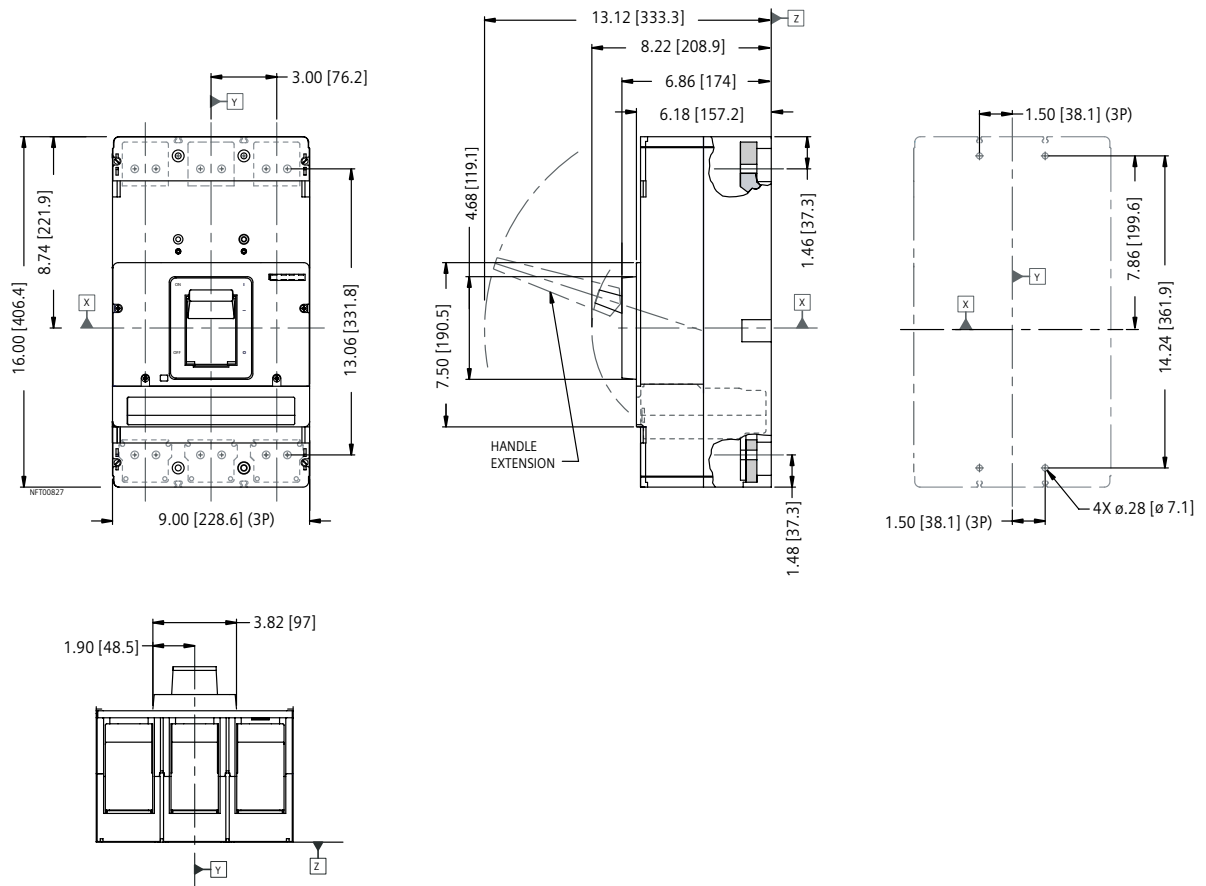

## Shipping weight, lbs. (kg)

Poles	Frame	Trip unit	Complete breaker
2,3	46.3 (21.0)	8.8 (4.0)	55.1 (25.0)

## Permissible mounting positions

