

CATALOG NO. MC1830F3100CEY

TYPE 3R ENCLOSURE (RAINPROOF) TOP OR BOTTOM FEED.

SUITABLE ONLY FOR USE AS SERVICE EQUIPMENT.

DEVICE RATING: 100 AMPS MAXIMUM, 208/120 VAC OR 240-120 VAC DELTA, THREE PHASE, FOUR WIRE.
METER SOCKET RATING: 100 AMPS CONTINUOUS.

THIS DEVICE HAS A MAXIMUM SHORT CIRCUIT CURRENT RATING OF 100,000 RMS SYMMETRICAL AMPERES AT 240 VAC MAXIMUM. (Watt-Hour meter not included in short circuit current rating). ANY CIRCUIT BREAKER INSTALLED, REPLACED OR ADDED IN THIS PANELBOARD MUST BE MANUFACTURED BY MURRAY OR SIEMENS AND MUST BE OF THE CORRECT TYPE AS INDICATED IN THE TABULATION BELOW.

MAX short circuit current rating in RMS symmetrical Amperes	Installed Service Disconnect	Field Installed Branch Circuit Breaker Types
100,000	100A MAX 300 VAC CLASS T FUSE	Murray MP-T, MP-HT, MP-MT, MH-T, MP-GT, MP-HGT, MP-ET, MP-HET OR SIEMENS OP, OPH, HQP, QT, QPF, QPHF, QE OR QEH

PANELBOARD SUITABLE FOR USE WITH BREAKERS MARKED 60/75°C. FOR BREAKERS WITH TRIPPED POSITION IN CENTER, RESET BREAKERS BY MOVING HANDLE TO "OFF" AND THEN TO "ON".
TERMINALS SUITABLE FOR USE WITH 60/75°C, AL/CU INSULATED WIRE

SIZE WIRE ONLY TO 60°C OR 75°C AMPACITY LIMITS AND IN ACCORDANCE WITH BREAKER MARKINGS AND WIRE BENDING SPACE REQUIREMENTS.

*SINGLE AND 2-POLE INDEPENDENT TRIP CIRCUIT BREAKERS RATED 120 OR 120/240 VAC MUST NOT BE CONNECTED TO THE HIGH LEG (SEE DIAGRAM) OR USED ON TWO WIRE CIRCUITS THAT DO NOT INCLUDE THE NEUTRAL AS ONE WIRE OF THE CIRCUIT.

TERMINAL TIGHTENING TORQUES, LB-IN

WIRE SIZE (AWG)	<input type="checkbox"/>	<input checked="" type="checkbox"/>	<input type="checkbox"/>	<input type="checkbox"/>	<input type="checkbox"/>	<input type="checkbox"/>
2/0	110	-	-	-	-	-
1/0-3	110	50	45	-	-	-
4	110	45	45	-	-	-
6	110	45	45	35	35	35
8	-	40	40	25	25	25
10-14	-	35	35	20	20	20

TEST BLOCK CIRCUIT CLOSING (DISCONNECT) NUT (5/8" ACROSS FLATS): TORQUE TO 50 LB-IN. SEE BREAKER MARKING FOR REQUIRED BREAKER TERMINAL TORQUES.

FOR EQUIPMENT GROUND BAR, MULTIPLE WIRES PER TERMINAL MAY BE USED AS INDICATED BELOW, TORQUE SAME AS ABOVE.

WIRE SIZE	LARGE HOLE, AWG	SMALL HOLE, AWG
1	#1/0-14CU, #1/0-12AL	#6-14CU, #6-12AL
2	#1/0-14CU, #1/0-12AL	#12-14CU, #12AL
3	#1/0-14CU, #1/0-12AL	-----

**EQUIPMENT GROUND (WHEN REQUIRED); EXCESS NEUTRAL TERMINALS MAY BE USED AS EQUIPMENT GROUND WIRE TERMINALS. PAINT HEADS OF BINDING SCREWS GREEN WHEN USED FOR EQUIPMENT GROUND WIRES.

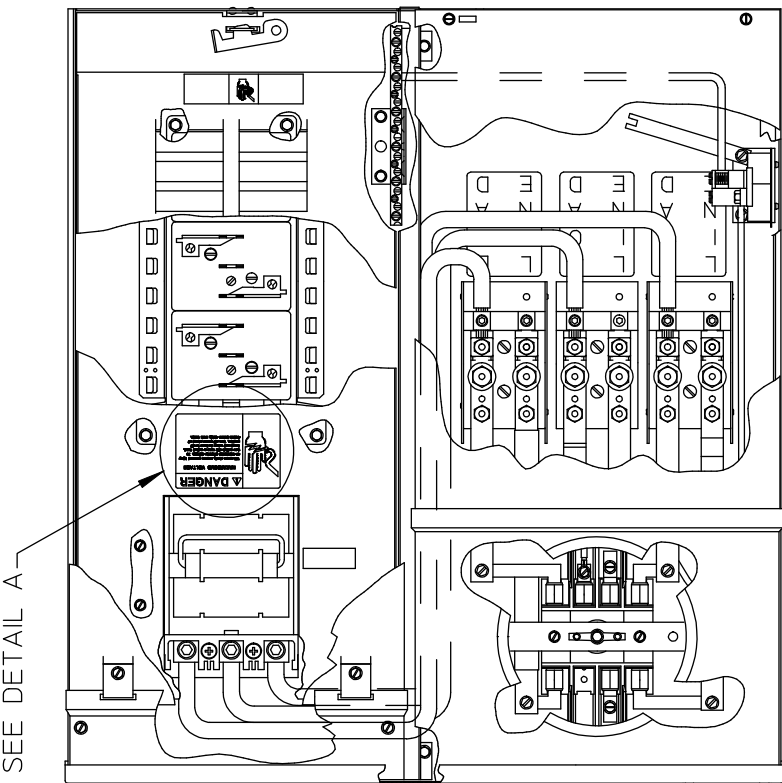
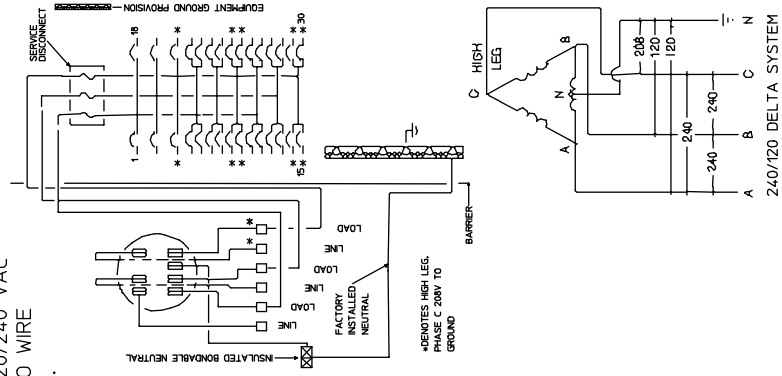

SEE DETAIL A

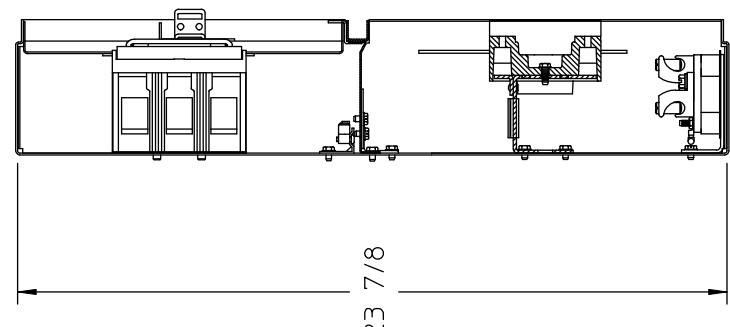

23 7/8

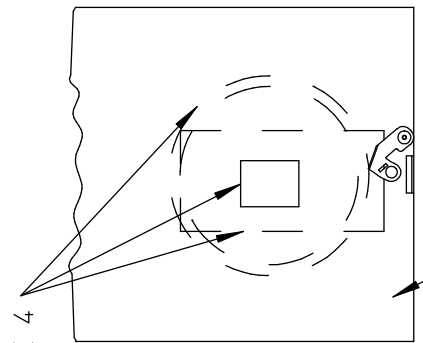

HINGE COVER ASSEMBLY

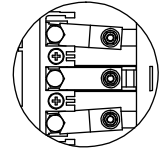

DETAIL A
ROTATED 90°
(DEADFRONT REMOVED)

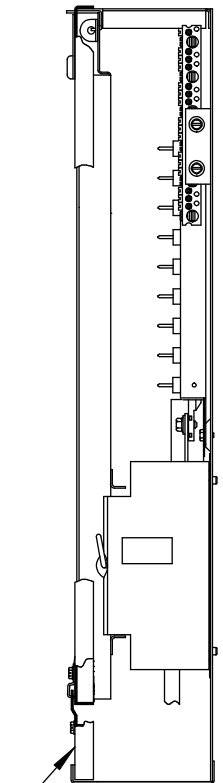

DOOR CAP COVER

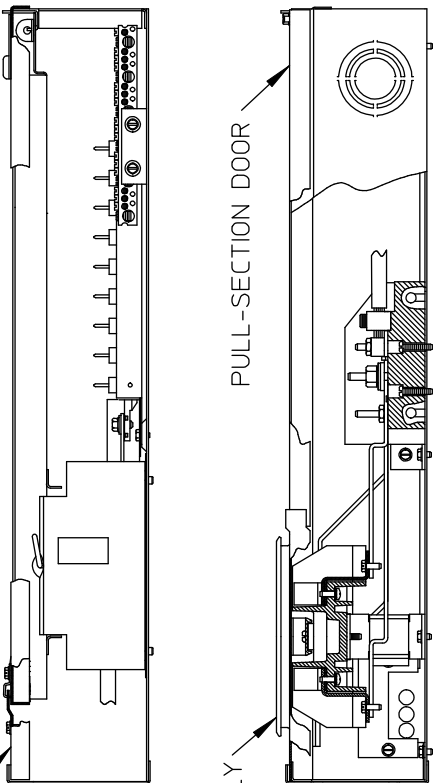

PULL-SECTION DOOR

RING STYLE COVER ASSEMBLY

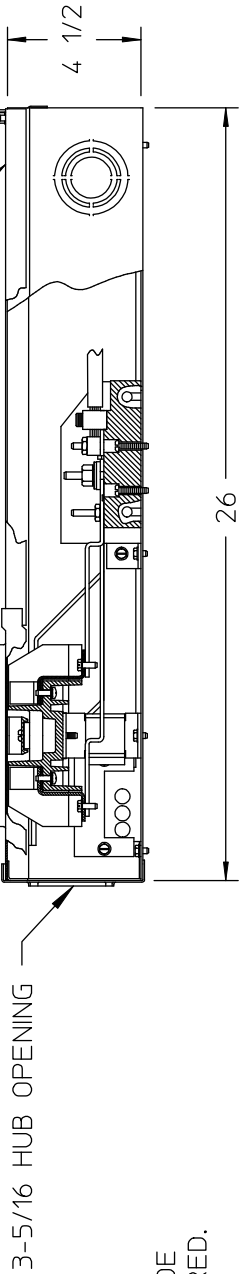

3-5/16 HUB OPENING

4 1/2

26

SEE NOTE 4

NOTES:

- 1) FINISH: GRAY
- 2) CABINET: 16GA. GALVANIZED STEEL
- 3) 100 AMP, 120/240 VAC 3 PHASE, 4 WIRE
- 4) SEALING RING, HUB COVER PLATE ASY, NEMA INSTRUCTION SHEET PLACED INSIDE OF BOX BEFORE HINGE COVER IS SECURED.
- 5) UL LISTED - FILE E 27485

FOR 1" FILLER PLATE ORDER ECQF3. FOR EQUIPMENT GROUND BAR ORDER ECLX SERIES, IF HUB IS REQUIRED SELECT FROM LIST BELOW.

RX TYPE HUBS

SIZE	CAT. NO.
1 1/2"	EC38598
2"	EC38599
2 1/2"	EC38600

UNLESS OTHERWISE SPECIFIED DIMENSIONS ARE IN INCHES
TOLERANCES:

.XX	
.XXX	
HOLE DIAMETER	
ANGULAR	
UNDIMENSIONED 90° ANGLES	
DWN	CJD
DATE	10-22-07
CHK	DATE
APVD	DATE

-CONFIDENTIAL-PROPERTY OF

Siemens Energy & Automation, Inc.

Residential Products Division

MTR SKT 100A 7T HO EUSERC

SIZE	ISSUE RELEASE NO.	DWG NO.	REV
B		MC1830F3100CEY	
SCALE	DO NOT SCALE DRAWING	SHEET	1 OF 1