



RDF880KN/NF

## Touch Screen Flush-mount Room Thermostats with KNX Communications

Under Floor Heating (UFH) control application

with an additional HMI for Variable Refrigerant Flow (VRF) commands via KNX S-mode

- Large display, touch screen with backlight
- VRF HMI: adjust setpoint, fan mode, fan speed and operating modes
- 2-position (ON/OFF) temperature control with potential free output for UFH via build-in / external temperature sensor
- Display room temperature value (°C) and relative humidity value (% r.h.) via a build-in temperature and humidity sensor
- One setpoint adjustment for both VRF HMI and UFH controls
- Fan auto and manual speed setting from 1 up to 7 speed
- Operating mode selection for VRF: AUTO, COOL, HEAT, FAN and DRY
- Operating mode selection for UFH: Comfort and Protection
- Economy operating mode for both VRF and UFH to save energy
- 2 multifunctional inputs (see details in functional descriptions)
- Adjustable control parameters for alternative settings
- KNX bus communications via S-mode and LTE-mode
- Integration to VRF system via S-mode and third party gateways
- Commissioning via ETS download
- Wizard function for fast commissioning via HMI
- Alarm / Error information
- AC 230 V operating voltage
- RDF880KN/NF: Mounting on recessed square 86 mm box with 60.3 mm fixing centers and min 40 mm depth, requires additional mounting frame to complete installation

More than just room temperature control via a connected VRF system or a UFH system or both:

Typical applications:

- Residential apartments
- Small office or commercial buildings
- Schools / Universities

For the VRF HMI, the unit interfaces to VRF systems via a third party gateway for:

- User application selection: - UFH only or VRF only or both
- Setpoint adjustment: - maximum / minimum limitations
- Fan speed adjustment: - auto / manual speeds (up to 7 speeds)
- Operating mode selection: - AUTO, HEAT, COOL, FAN and DRY
- Economy mode: - energy saving
- Fan swing adjustment (optional): - auto swing or fix at any position (10)
- Delay off timer (optional): - allow up to 23 hours operations before off

For the control of the following pieces of heating equipment:

- Floor Heating
- Thermal valves or zone valves
- Gas or oil boilers
- Fans
- Pumps

The configuration can be done locally or remotely via one of the following:

- Local HMI & DIP switches
- Synco ACS (UFH only)
- ETS5 (binding S-mode objects for VRF & UFH)

## Functions

---

- Room temperature control via a built-in or external room temperature sensor
- Calibrations for both internal temperature and relative humidity sensors
- Display of current room temperature or setpoint in °C
- Minimum and maximum limitation of room temperature setpoint
- Fan speed adjustment, auto, manual (up to 7 speeds)
- Selection of VRF operating mode:  
→ AUTO, HEAT, COOL, FAN and DRY
- Selection of UFH operating mode:  
→ Comfort and Protection
- Energy saving (Economy mode) for both VRF and UFH
- Key lock function: unlock, total lock and setpoint lock
- 2 multifunctional inputs, freely selectable for:
  - External room temperature or return air temperature sensor
  - Window contact
  - Fault input
  - Monitor input for temperature sensor or switch state
- Floor heating temperature limitation
- Display of outdoor temperature and time scheduling via KNX bus
- Reload factory settings for commissioning and control parameters

**Optional:** enable / disable via parameters





- Relative humidity display via a built-in humidity sensor
- Fan swing selection: auto swing or fix at any position (up to 10)
- Delay off timer: up to 23 hour operations
- Chinese text display for 4 navigation icons

## Applications

RDF880KN/NF is designed to provide easy-to-understand HMI for any existing VRF system installed in residential homes and apartments where Under Floor Heating (UFH) room thermostat may be required at the same time.

RDF880KN/NF has three kinds of applications including VRF HMI or UFH or both.

Applications are selectable via DIP switches.

	Download via ETS (All in OFF positions)
	UFH only
	VRF HMI only
	VRF HMI and UFH

For selection under application mode via HMI, refer to user manual A6V11272225 for selecting applications.

## UFH Application

For the UFH application, RDF880KN/NF provides an ON/OFF output to control water valve to maintain a comfort level of room temperature.

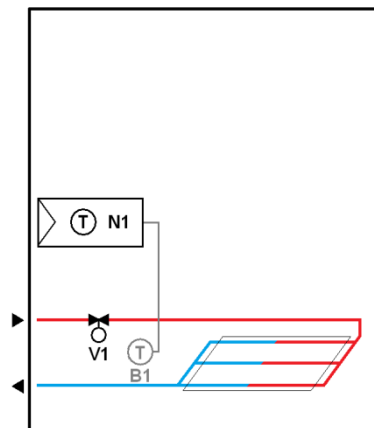

*Room thermostat to control the valve for the floor heating application*

## VRF Application (HMI only)

For the VRF application, RDF880KN/NF provides an easy-to-understand HMI for adjusting frequent used operations of the VRF systems such as adjustments of temperature setpoint, fan speed, VRF operating mode, etc.



Since all VRF brands have their own communication protocols between the remote control unit and VRF equipments (e.g. indoor or outdoor units), RDF880KN/NF can send all standard KNX commands (S-mode KNX objects) via the KNX bus to a third party KNX/VRF gateway (as a protocol converter) and then communicate indirectly with the VRF indoor or outdoor units. Effectively, it works similarly like a remote control unit of a VRF system.

Note that RDF880KN/NF cannot replace all functions of the remote control unit of the VRF system but the following typical VRF functions:

- **Temperature** - provide current room temperature value  
- adjust temperature setpoint
- **Fan** - select auto or manual speed up to 7 levels  
- select auto swing or fixed swing positions
- **Operation** - set to AUTO, HEAT, COOL, FAN and DRY

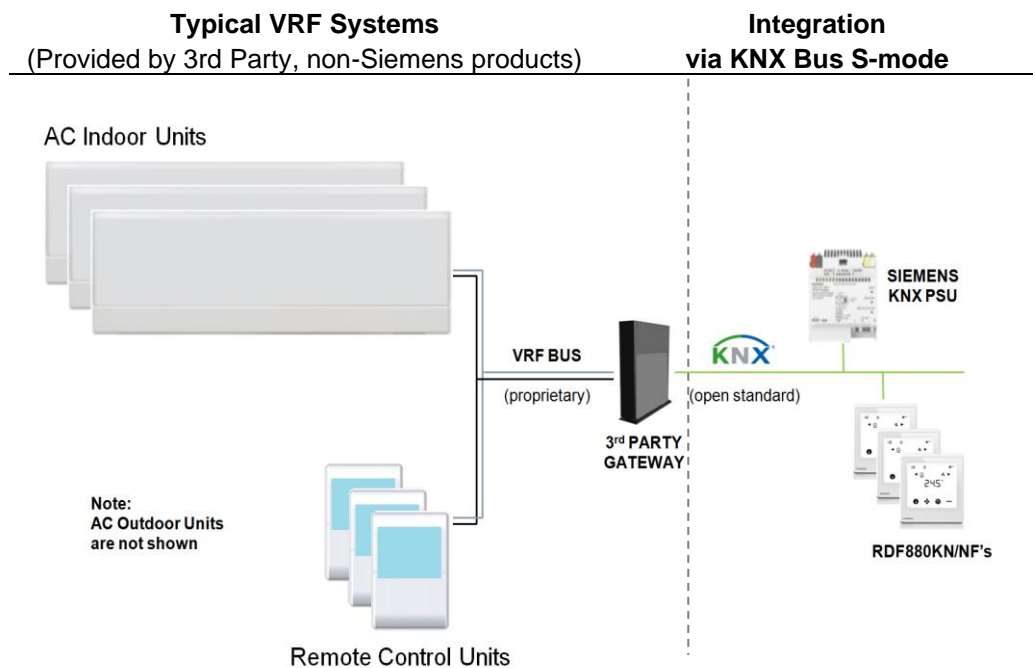

## Other Heating Applications

RDF880KN/NF is not limited to UFH applications but also for the following heating applications such as radiators, wall hung boilers, etc.

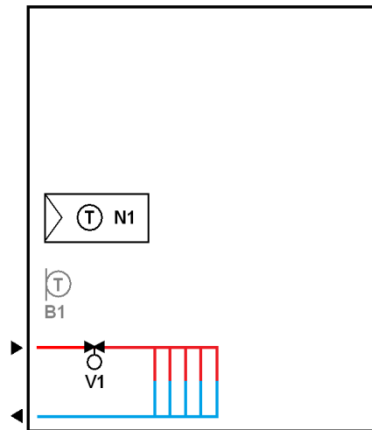

Room thermostat to control the valve of the radiator application

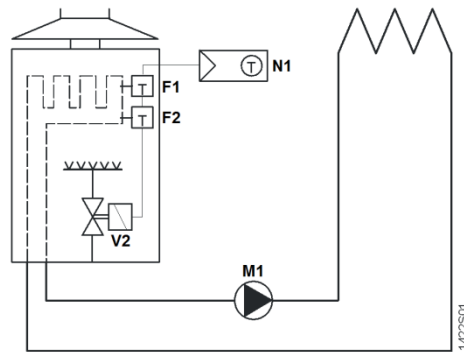

Room thermostat with direct control of a gas-fired wall-hung boiler

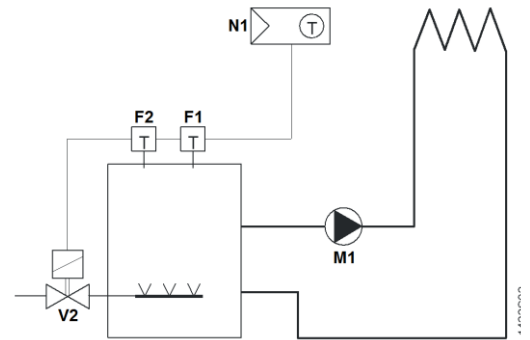

Room thermostat with direct control of a gas-fired floor-standing boiler

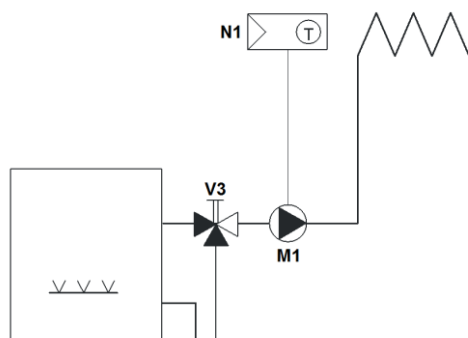

Room thermostat with direct control of a heat pump (pre-controlled by manual mixing valve)

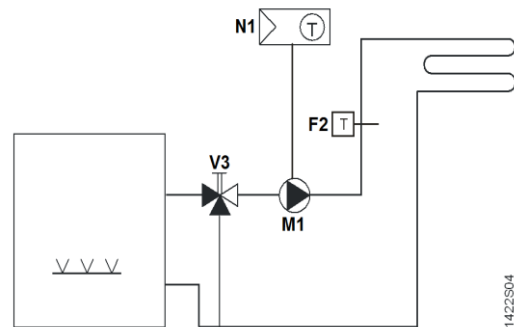

Room thermostat with direct control of hydronic floor heating system

F1 Thermal reset limit thermostat  
 F2 Safety limit thermostat  
 M1 Circulating pump

N1 Room thermostat  
 V1 2-port valve  
 V2 Mixing 3-port valve with manual adjustment  
 V3 Magnetic valve

## Type summary

Product no.	Stock no.	Operating voltage	Control outputs			Suitable for
			3-pos	ON/OFF	DC 0..10 V	
RDF880KN/NF <sup>2)</sup>	S55770-T398	AC 230 V	--	1 <sup>1)</sup>	--	Square conduit box <sup>2)</sup>

<sup>1)</sup> ON/OFF output with potential free input from AC 24...230 V













<sup>2)</sup> Mounting frames are not included and must be ordered separately. (See "Accessories")

## Ordering

- When ordering, indicate product number, SSN and name.  
e.g. **RDF880KN/NF (S55770-T398) heating thermostat with VRF HMI**
- A mounting frame or multi-frame must be ordered for RDF880KN/NF installation. (See "Accessories")
- Order valve actuators separately.

## Equipment combinations

ON/OFF actuators

Type of unit	Product no.	Data sheet
Cable temperature sensor or changeover sensor cable length 2.5 m NTC (3 kΩ at 25 °C)	 <b>QAH11.1</b> <sup>d)</sup>	1840
Room temperature sensor NTC (3 kΩ at 25 °C)	 <b>QAA32</b>	1747
Cable temperature sensor, cable length 4 m NTC (3 kΩ at 25 °C)	 <b>QAP1030/UFH</b>	1854
Electromotoric ON/OFF actuator	 <b>SFA21...</b>	4863
Electromotoric ON/OFF valve and actuator <sup>a)</sup>	 <b>MVI.../MXI...</b>	A6V11251892
Zone valve actuators <sup>a)</sup>	 <b>SUA...</b>	4832
Thermal actuator <sup>b)</sup>	 <b>STA23...</b>	4884
Thermal actuator <sup>c)</sup>	 <b>STP23...</b>	4884
Damper actuator	 <b>GDB..</b>	4634
Damper actuator	 <b>GSD..</b>	4603
Damper actuator	 <b>GQD..</b>	4604
Rotary damper actuator	 <b>GXD..</b>	4622

<sup>a)</sup> only available in AP, UAE, SA and IN

<sup>b)</sup> for radiator valve

<sup>c)</sup> for small valves 2.5 mm

d) both QAH11.1 and QAP1030/UFH are for floor heating applications, such as temperature limitation controls. QAP1030/UFH has a special head and 4 m long that is more suitable for such application.

Note: Refer to data sheets of the actuators for the maximum number of parallel operation.

## Accessories

---

Designation	Product no. / SSN	Data sheet
Single mounting frame <sup>*)</sup> , Ivory White 	<b>ARG800.1 / S55770-T370</b>	--
KNX Power supply 160 mA (Siemens BT LV)	<b>5WG1 125-1AB02</b>	--
KNX Power supply 320 mA (Siemens BT LV)	<b>5WG1 125-1AB12</b>	--
KNX Power supply 640 mA (Siemens BT LV)	<b>5WG1 125-1AB22</b>	--

<sup>\*)</sup> See the dimensions of mounting frame on page 24.

**Mechanical design**

The thermostats consist of the following parts:

- Front panel with electronics, operating elements and built-in room temperature and relative humidity sensors.
- Mounting base with power electronics.
- Mounting frame is an additional part to complete the installation for RDF880KN/NF, e.g. single or multi-frames.

The rear of the mounting base contains the screw terminals. Slide the front panel in the mounting base and snap on.

**Operation and settings**



**Display**

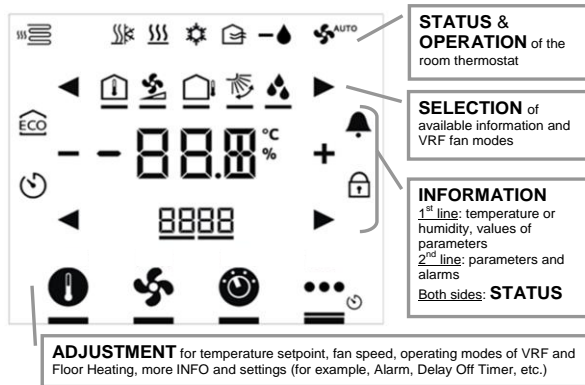

Status symbols:			
	Economy active		Alarm / Service active
	Delay timer active		Key lock active
	Floor heat active		Fan active
		VRF operating modes	
Selection symbols:			
	Indoor temperature		VRF fan speed
	Outdoor temperature		VRF fan swing
	Relative humidity		

Operational icons:	
	Increment, decrement OR selection
	Selection OR move to next items
	Temperature, relative humidity OR parameter values, etc.
	Parameters OR password, etc.
	Setpoint mode (temperature only)
	Fan mode OR fan speed mode
	VRF & floor heat operating modes
	More info & settings



See the "Reference documentation", page 21, for information on how to engineer the KNX bus (topology, bus repeaters, etc.) and how to select and dimension connecting cables for supply voltage and field devices.

## Mounting and installation

Mount the room thermostat on a conduit box. Do not mount on a wall in niches or between bookshelves, behind curtains, above or near heat sources, or exposed to direct solar radiation. Mount about 1.5 m above the floor.

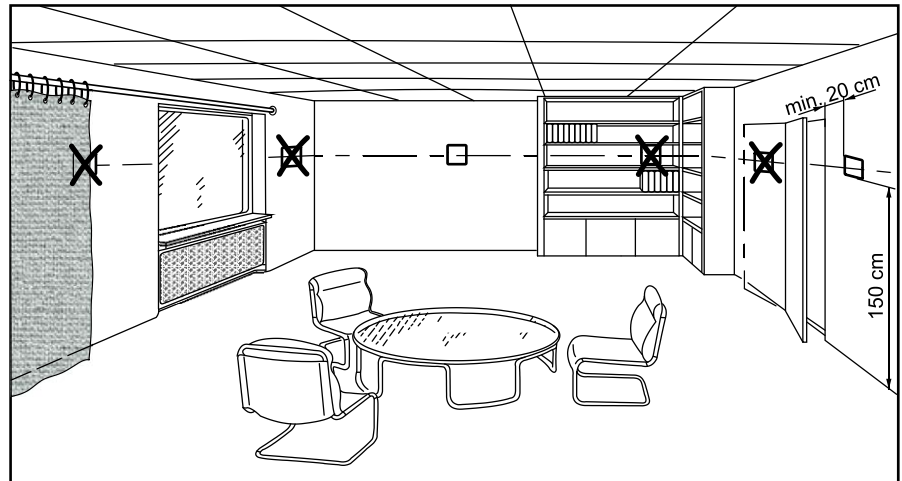

### Mounting / Dismounting



- Do not apply excessive force on screws! The deformation of the mounting frame may lead to improper connections and operation of the unit.
- Mount the room thermostat on a clean, dry indoor place without direct airflow from a heating / cooling device, and not exposed to drips or water.
- Before removing the front cover, disconnect the power supply.

### Wiring



See the User Manual for the installation instructions enclosed with the thermostat.

- Comply with local regulations to wire, protection and earth the thermostat.
- The device has no internal fuse for supply lines to fan and actuators. To avoid risk of fire and injury due to short-circuits, the AC 230 V mains supply line must have a circuit breaker with a rated current of no more than 10 A.
- The wiring cross section used for power supply (L, N) and 230 V outputs (Qxx - N) must be adapted to the preceding overload protection elements (max 10 A) under all circumstances. Comply under all circumstances with local regulations.
- Properly size the cables to the thermostat and valve actuators for AC 230 V mains voltage.
- Cables of SELV inputs X1-M / X2-M: Use cables with min 230 V insulation, as the conduit box carries AC 230 V mains voltage.
- Inputs X1-M or X2-M of different units (e.g. window contact) may be connected in parallel with an external switch. Consider overall maximum contact sensing current for switch rating.
- KNX communication cables (input CE+ / CE-): Use cables with min 230 V insulation, as the conduit box carries AC 230 V mains voltage.
- When a KNX bus power supply is connected on the line with communicating thermostats and Synco controllers, the internal KNX power supply of the Synco controllers must be switched off.
- No cables provided with a metal shield.
- Disconnect from supply before opening the cover.

## Commissioning notes

### Before power up

Select DIP switch setting is required for RDF880KN... thermostats.

COMMISSIONING: Download via ETS

1. DIP switch setting

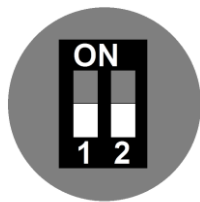

All in OFF positions

2. First power up



Press to turn ON

3. Touch & hold this icon > 5 s to enter Programming mode



4. Ready for downloading address & application

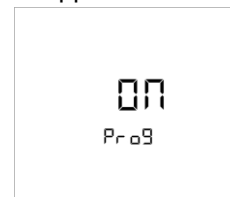

Touch "ON" to exit

COMMISSIONING: Local via DIP Switches

1. Set application via DIP switches

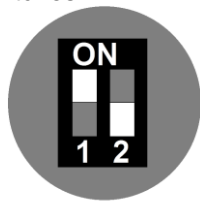

DIP switch positions		APPLICATION
1	2	
ON	ON	VRF+FLOOR HEAT
OFF	ON	VRF ONLY
ON	OFF	FLOOR HEAT ONLY

2. Configure basic control parameters via Wizard

See Configure Parameters via Wizard in **Wizard function**.

### Wizard function

After power up, the wizard function guides users to configure the basic parameters for normal operation according to the table below.

Touch ◀ / ▶ to advance / return to any parameter;  
Touch + / - to select any desired available values.

LCD display	Parameter	Range	Factory setting
	Operation Selector	1: COMF > PROT 2: COMF > ECON > PROT	1
	Internal Relative Humidity Sensor	OFF: Disable ON: Enable	ON
	Maximum Fan Speed	1 to 7	3
	Maximum Fan Swing	0: no swing function 1 to 10 positions	0
	Chinese Text Display	0: Disable 1: Enable	0
	End of wizard setup	-	-

If more details are required about parameters, refer to basic documentation CE1P3174.

## Reset

To reload factory setting for all parameters, set parameter P71 to **ON**. Restart the thermostat after reset, all LCD segments flash, indicating that the reset is correct. 3 seconds later, the thermostat is ready for commissioning by qualified HVAC staff.

## Applications

RDF880KN... thermostats are for VRF HMI and heating applications.

Configure or changing parameter settings during commissioning using one of the following tools:

- Local HMI
- Synco ACS
- ETS5

## Connect tool

Connect the Synco ACS or ETS tools to the KNX bus cable at any point for commissioning:

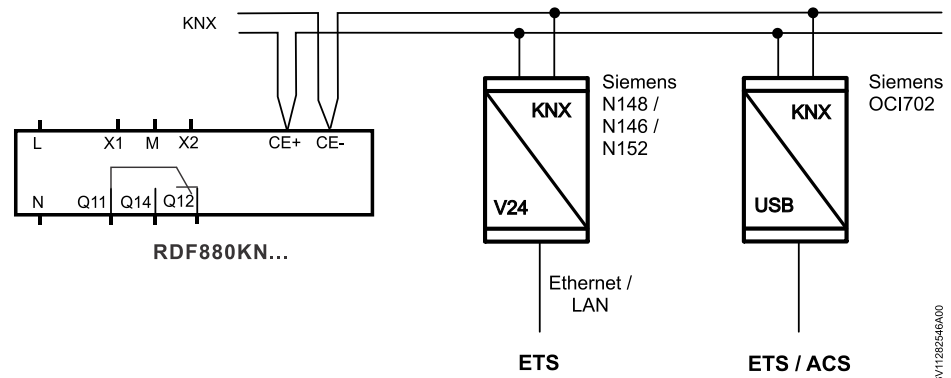

ACS and ETS5 require an interface:

- Ethernet/LAN KNX interface (such as Siemens N148 / N146 / N152)
- OCI702 USB-KNX interface

Note: An external KNX bus power supply is required if an RDF880KN/NF is connected directly to a tool (ACS or ETS5) via KNX interface.

## Setting parameters

### Service level parameters

Parameter	Name	Factory setting	Range	Resolution
	Service level			
P02	User operating mode profile (mode button)	1 = Auto - Comfort - Protection	1 = Auto - Comfort - Protection 2 = Auto - Comfort - Economy - Protection	
P05	Sensor calibration (intern, extern)	0 K	-5 K...+5 K	0.5 K
P06	Standard temperature display	0 = Room Temperature or Relative Humidity	0 = Room Temperature or Relative Humidity 1 = Setpoint for Room Temperature	
P08	Comfort setpoint	21 °C	P9 to P10	0.5 K
P09	Minimum setpoint in Comfort mode	5 °C	5...P10 (P10 = 40 °C max)	0.5 K
P10	Maximum setpoint in Comfort mode	35 °C	P09...40 °C (P09 = 5 °C min)	0.5 K
P11	Economy heating setpoint	15 °C	OFF, 5...40 °C	0.5 K
P14	Keylock function	0	0 = Unlock 1 = Locked 2 = Setpoint	
P16	Buzzer function	ON = Enable	OFF = Disable ON = Enable	
P22	Internal r.h. sensor	ON = Enable	OFF = Disable ON = Enable	
P23	Calibration internal r.h. sensor	0%	±20%	1%
P27	Operating mode settings after power failure or reset	0 = Return to Previous Operating Mode / User Settings	0 = Return to Previous Operating Mode / User Settings 1 = Protection Mode	
P28	Timer with delay Off	OFF = Disable	OFF = Disable (do not display Delay Timer Mode symbol) ON = Enable (display Delay Timer Mode symbol)	1 hour
P29	User level password	0000	0000 - 9999	

**Note:** Parameter display depends on the selected application and function.

### Expert level parameters with diagnostics and test

Parameter	Name	Factory setting	Range	Resolution
	Expert level			
P30	P-band / Switching differential in heating mode	1 K	0.5...6 K	0.5 K
P38	Functionality of X1	0 = --- no function	0 = --- (no function) 1 = Room temp ext / Return temp (AI) 3 = Window open detection (DI) 6 = Fault input (DI) 7 = Monitor input [Digital] 8 = Monitor input [Temp]	

Parameter	Name	Factory setting	Range	Resolution
	Expert level			
P39	Operating action of X1 if digital input	0 = Normally open / Open	0 = Normally open / Open 1 = Normally closed / Close	
P40	Functionality of X2	0 = --- no function	0 = --- (no function) 1 = Room temp ext / Return temp (AI) 3 = Window open detection (DI) 6 = Fault input (DI) 7 = Monitor input [Digital] 8 = Monitor input [Temp]	
P41	Operating action of X2 if digital input	0 = Normally open / Open	0 = Normally open / Open 1 = Normally closed / Close	
P48	Minimum output on time 2-position control output	1 min.	1...20 minutes	1 min.
P49	Minimum output off time 2-position control output	1 min.	1...20 minutes	1 min.
P51	Floor heat limit temperature	OFF	OFF, 10...50 °C	1 K
P53	Fan speed	3 = 3-speed	1 = maximum 1-speed 2 = maximum 2-speed 3 = maximum 3-speed 4 = maximum 4-speed 5 = maximum 5-speed 6 = maximum 6-speed 7 = maximum 7-speed	
P54	Fan Swing Position	0 = Swing function is not available	0 = Swing function is not available 1 = Maximum 1 Position 2 = Maximum 2 Positions 3 = Maximum 3 Positions 4 = Maximum 4 Positions 5 = Maximum 5 Positions 6 = Maximum 6 Positions 7 = Maximum 7 Positions 8 = Maximum 8 Positions 9 = Maximum 9 Positions 10 = Maximum 10 Positions	
P65	Protection heating setpoint	8 °C	OFF, 5...40 °C	0.5 K
P68	Prolong Comfort period	0: OFF	0: OFF 1...360 min	1 min
P69	Temporary setpoint comfort (see also comfort basic setpoint)	OFF = Disable	OFF = Disable ON = Enable	
P71	Reload factory setting	OFF = Disable	OFF = Disable ON = Reload factory setting Reload starts only after exits parameter mode.	
P81	Device address	255	1...255	1
P82	Geographical zone (apartment)	--- (out of service)	---, 1...126	1
P83	Geographical zone (room)	1	---, 1...63	1

Parameter	Name	Factory setting	Range	Resolution
	Expert level			
P84	Heat distr. zone heating coil	--- (out of service)	---, 1...31	1
P88	Substitution for PreComfort (from BUS)	0 = Economy	0 = Economy 1 = Comfort	
P98	Chinese text display enable	0: Disable	0: Disable 1: Enable	
P99	Installer Level Password	9999	5000 - 9999	

Parameter	Name	Factory setting	Range	Resolution
	Diagnostics and test			
d01	Application no	Diagnose	0 = --- (No application) 1 = Floor Heating only 2 = VRF only 3 = VRF and Floor Heating	
d02	X1 status	Diagnose (display values according to the selected function of X1: DI, AI, HC changeover, etc)	0 = Not activated (for DI) 1 = Activated (DI) 0...49 °C = cur. temp. value (for AI) 00 = HC input short 100 = HC input open	
d03	X2 status	Diagnose (display values according to the selected function of X2: DI, AI, HC changeover, etc)	0 = Not activated (for DI) 1 = Activated (DI) 0...49 °C = cur. temp. value (for AI) 00 = HC input short 100 = HC input open	
d07	Software version Show Ux.xx			
d11	Floor Heating NC Output Status (Q12)	Diagnose	OPE = OPEN CLO = CLOSE	
d12	Floor Heating NO Output Status (Q14)	Diagnose	OPE = OPEN CLO = CLOSE	

**Control parameters** The thermostat's control parameters can be set to ensure optimum performance of the entire system (refer to basic documentation CE1P3174).

The parameters can be adjusted using

- Local HMI
- Synco ACS
- ETS5

For commissioning via local HMI, refer to user manual A6V11272225 for setting the passwords.

Control sequence

- Only heating sequence is available.

Calibrate sensor

- Recalibrate the temperature sensor if the room temperature displayed on the thermostat does not match the room temperature measured (after min. 1 hour of operation). To do this, change parameter P05.

LCD display	Parameter	Range	Factory setting
	Sensor Calibration	-5...5 K	0 K

Setpoint and range limitation

- We recommend to review heating setpoint and their range limitation via parameters P08...P11. If necessary, adjust them to achieve maximum comfort and save energy.

**Programming mode** The programming mode helps identify the thermostat in the KNX network during commissioning.

Touch and hold  for more than 5 seconds to activate programming mode, which is indicated on the display with **Pr09**. Programming mode remains active until thermostat identification is complete.

**Assign KNX device address** Assign device address (P81) via HMI, ACS or ETS5.  
With device address set to 255, the communication is deactivated (no exchange of process data).

**Assign KNX group addresses** Use ETS5 to assign the KNX group addresses of the RDF communication objects.

**KNX serial number** Each device has a unique KNX serial number inside the front panel. An additional sticker with the same KNX serial number is enclosed in the packaging box. This sticker is intended for installers for documentation purposes.

**KNX communications** The RDF880KN... room thermostats support communications as per KNX specification.

- S-mode: Standard mode; engineering using group addresses.
- LTE mode: Logical Tag Extended mode, for easy engineering, used in conjunction with Synco.

S-mode

- This mode corresponds to KNX communications. Connections are established via ETS by assigning communication objects to group addresses.

LTE mode

- LTE mode is specifically designed to simplify engineering. In contrast to S-mode, there is no need to create individual connections (group addresses) in the tool. The devices establish connections autonomously.



## KNX S-mode communication object

Obj.	Object Name	Function	Type	Length	CRWTU	Descriptions / Selections: visibility depends on DIP switch setting
4	Fault information	alarm info	219.001	6 bytes	CT	<b>CONTROL: all DIP switch Settings</b> It is a command to send out common alarm output in alarm numbers/codes.
5	Fault state	faulty/normal	1.005	1 bit	CT	<b>CONTROL: all DIP switch Settings</b> It is a command to set the alarm flag if an alarm occurs.
6	Fault transmission	enable/disable	1.003	1 bit	CWU	<b>STATUS: all DIP switch Settings</b> A value (enable or disable) is received from a supervisory alarm system to enable or disable the broadcasting of alarms by the devices. This has no impact on the local display of alarms. The sending of faults/alarms will be enabled automatically after time out (48 hours).
7	Room operating mode: Preselection	HVAC mode	20.102	1 byte	CWTU	<b>CONTROL/STATUS: use for DIP switch Setting → 1: UFH, 3: BOTH</b> To change or to receive the room operating mode selection via the bus. <b>Note:</b> The thermostat will switch from Precomfort to Economy or Comfort mode (selectable via P88).
8	Room operating mode: Preselection Auto	switch	1.001	1 bit	CW	<b>STATUS: use for DIP switch Setting → 1: UFH, 3: BOTH</b> The value is received to switch the room operating mode to Auto, Comfort, Economy or Protection.
9	Room operating mode: Preselection Comfort	switch	1.001	1 bit	CW	
10	Room operating mode: Preselection Economy	switch	1.001	1 bit	CW	
11	Room operating mode: Preselection Protection	switch	1.001	1 bit	CW	
12	Room operating mode: Time switch	HVAC mode	20.102	1 byte	CWU	<b>STATUS: use for DIP switch Setting → 1: UFH, 2: VRF</b> A time schedule defining the required operating modes is provided by a central time switch or a supervisor. Protection mode has the highest priority and cannot be overridden. (also refer to P88 - Precomfort → Economy or Comfort)
13	Room operating mode: Time switch Comfort	switch	1.001	1 bit	CW	<b>STATUS: use for DIP switch Setting → 1: UFH, 2: VRF</b> The value is received to switch the room operating mode to Auto, Comfort, Economy or Protection according to a time schedule provided by a central time switch or a supervisor.
14	Room operating mode: Time switch Economy	switch	1.001	1 bit	CW	
15	Room operating mode: Time switch Protection	switch	1.001	1 bit	CW	
16	Room operating mode: State	Comfort Economy Protection	20.102	1 byte	CRT	<b>CONTROL: use for DIP switch Setting → 1: UFH, 3: BOTH</b> It is a command to set the operating mode to Comfort, Economy or Protection depending on user selection, window contact, etc.
17	Room operating mode: State Comfort	switch	1.001	1 bit	CT	<b>CONTROL: use for DIP switch Setting → 1: UFH, 3: BOTH</b> It is a command to switch the room operating mode to Comfort, Economy or Protection.
18	Room operating mode: State Economy	switch	1.001	1 bit	CT	
19	Room operating mode: State Protection	switch	1.001	1 bit	CT	
20	Room operating mode: Window state	open/close	1.019	1 bit	CWU	<b>STATUS: all DIP switch Settings</b> A value "1" (open) is received to set operating mode to Protection (UFH) or Off (VRF) i.e. UFH to Protection, VRF to Off. A value "0" (close) is received to switch back to the previous operating mode "Window state" is received from a KNX control device or via the local window contact X1, X2 (P38, P40). <b>Note: Only one input source must be used, either local input X1/X2 or KNX bus.</b>
21	Room temperature	temperature value (°C)	9.001	2 bytes	CRT	<b>CONTROL: all DIP switch Settings</b> It is a command to send out the current room temperature measured using built-in or external sensor (via X1 or X2).
22	Room temp: Comfort basic setpoint	temperature value (°C)	9.001	2 bytes	CWU	<b>STATUS: all DIP switch Settings</b> If temporary setpoint function is enabled (P69=ON), after any operating mode changes, the setpoint will be reset to the Comfort basic setpoint. <b>Note:</b> User setpoint via the local HMI may be overwritten during a system startup from a central control unit, e.g.RMB795B.
23	Room temp: Comfort setpoint	temperature value (°C)	9.001	2 bytes	CWTU	<b>CONTROL/STATUS: all DIP switch Settings</b> Communication object is used to shift the setpoint for the thermostat. Same priority as local setpoint shift on the thermostat. <b>Note:</b> The Comfort basic setpoint (object 22) is not changed.
24	Room temp: Current setpoint	temperature value (°C)	9.001	2 bytes	CRT	<b>CONTROL: all DIP switch Settings</b> It is the command to send out for the current setpoint under current operating mode, including shift, compensation, etc., used by the thermostat for room temperature control.
25	Heating output primary	percentage (0..100%)	5.001	1 byte	CRT	<b>CONTROL: use for DIP switch Setting → 1: UFH, 3: BOTH</b> It is a command to send out to indicate the current position of the heating actuator when UFH is active.
31	VRF Operating Mode: State	HVAC control mode	20.105	1 byte	CWU	<b>STATUS: all DIP switch Settings</b> The value of the VRF operating mode is set by a KNX control device. 0 - Auto; 1 - Heat; 3 - Cool; 9 - Fan; 14 - Dry
33 *)	Fan operation	switch	1.001	1 bit	CRWTU	<b>CONTROL/STATUS: use for DIP switch Setting → 2: VRF</b> It is a command to set the current fan mode to the VRF: Auto (0); Manual (1).

Obj.	Object Name	Function	Type	Length	CRWTU	Descriptions / Selections: visibility depends on DIP switch setting										
35	Fan speed: preselection	percentage (0..100%)	5.001	1 byte	CRWTU	<p><b>CONTROL/STATUS: use for DIP switch Setting → 2: VRF</b> It is a command to set the fan speed (ECM) – depends on value of P53. e.g. if P53 = 3, indicates the current fan speed as a value 0...100%</p> <table border="1"> <thead> <tr> <th>Speed</th> <th>Fan output (physical KNX value)</th> </tr> </thead> <tbody> <tr> <td>OFF</td> <td>0% (0)</td> </tr> <tr> <td>1</td> <td>33% (84)</td> </tr> <tr> <td>2</td> <td>66% (186)</td> </tr> <tr> <td>3</td> <td>100% (255)</td> </tr> </tbody> </table>	Speed	Fan output (physical KNX value)	OFF	0% (0)	1	33% (84)	2	66% (186)	3	100% (255)
Speed	Fan output (physical KNX value)															
OFF	0% (0)															
1	33% (84)															
2	66% (186)															
3	100% (255)															
36	Fan speed	counter pulses (0..255)	5.010	1 byte	CRT	<p><b>CONTROL: use for DIP switch Setting → 2: VRF</b> It is a command to set the fan speed – depends on value of P53. 0 – Auto; 1 - Speed 1; 2 - Speed 2; 3 - Speed 3;4 - Speed 4; 5 - Speed 5; 6 - Speed 6; 7 - Speed 7</p>										
37	Fan speed status	counter pulses (0..255)	5.010	1 byte	CWU	<p><b>STATUS: use for DIP switch Setting → 2: VRF</b> The value of fan speed received will be set and displayed on HMI. Speed depends on value of P53: 0 – Auto; 1 - Speed 1; 2 - Speed 2; 3 - Speed 3;4 - Speed 4; 5 - Speed 5; 6 - Speed 6; 7 - Speed 7</p>										
38	VRF Operating Mode	HVAC control mode	20.105	1 byte	CRT	<p><b>CONTROL: use for DIP switch Setting → 2: VRF</b> It is a command to set the VRF operating mode for VRF equipment. 0 - Auto; 1 - Heat; 3 - Cool; 9 - Fan; 14 - Dry</p>										
39	X1: Temperature	temperature value (°C)	9.001	2 bytes	CRT	<p><b>CONTROL: all DIP switch Settings</b> Indicate the values of the temperature sensors connected to the local inputs X1/X2 (P38/P40).</p> <p><b>CONTROL: all DIP switch Settings</b> Indicates the logic state of the digital inputs (P39 for X1, P41 for X2).</p>										
41	X2: Temperature	temperature value (°C)	9.001	2 bytes	CRT											
40	X1: Digital	switch	1.001	1 bit	CRT											
42	X2: Digital	switch	1.001	1 bit	CRT											
43	Control on/off	switch	1.001	1 bit	CRT	<p><b>CONTROL: use for DIP switch Setting → 2: VRF</b> It is a command to turn on and off the VRF equipment. 0 - Off; 1-On</p>										
44	Control vane up/down position	counter pulses (0..255)	5.010	1 byte	CRT	<p><b>CONTROL: use for DIP switch Setting → 2: VRF</b> It is a command to set the vane position of the VRF equipment. 0 – Auto; 1 - Pos1; 2 - Pos2; 3 - Pos3; 4 - Pos4; 5 - Pos5; 6 - Pos6; 7 - Pos7; 8 - Pos8; 9 - Pos9; 10 - Pos10</p>										
45	Control vane up/down swing	boolean	1.002	1 bit	CRT	<p><b>CONTROL: use for DIP switch Setting → 2: VRF</b> It is a command to set the vane to a stop position or auto swing. The vane position depends on the object, Control vane up/down position (44). 0 - Stop; 1 – Swing</p>										
46	Control eco mode	start/stop	1.01	1 bit	CRT	<p><b>CONTROL: use for DIP switch Setting → 2: VRF</b> It is a command to enable or disable the ECO mode of the VRF equipment. 0 - Stop; 1 – Start</p>										
47	Status on/off	Switch	1.001	1 bit	CWU	<p><b>STATUS: use for DIP switch Setting → 2: VRF</b> A value is received from a KNX control device to turn on and off the VRF equipment. 0 - Off; 1-On</p>										
48	Status vane up/down position	counter pulses (0..255)	5.010	1 byte	CWU	<p><b>STATUS: use for DIP switch Setting → 2: VRF</b> A value is received from a KNX control device to set the vane position of the VRF equipment. 0 – Auto; 1 - Pos1; 2 - Pos2; 3 - Pos3; 4 - Pos4; 5 - Pos5; 6 - Pos6; 7 - Pos7; 8 - Pos8; 9 - Pos9; 10 - Pos10</p>										
49	Status vane up/down swing	boolean	1.002	1 bit	CWU	<p><b>STATUS: use for DIP switch Setting → 2: VRF</b> A value is received from a KNX control device to set the vane of the VRF equipment to stop or auto swing. 0 - Stop; 1 – Swing</p>										
50	Status eco mode	Switch	1.001	1 bit	CWU	<p><b>STATUS: use for DIP switch Setting → 2: VRF</b> A value is received from a KNX control device to set the VRF equipment in ECO mode. 0 - Off; 1-On</p>										
51	Room relative humidity	Humidity %	9.007	2 bytes	CRT	<p><b>CONTROL: all DIP switch Settings</b> It is the command to send out for the current value of relative humidity.</p>										
53	Room temp: Economy heating setpoint	temperature value (°C)	9.001	2 bytes	CWU	<p><b>STATUS: all DIP switch Settings</b> A value is received from a KNX control device to update parameter P11.</p>										
55	Application selection: State	counter pulses (0..255)	5.010	2 bytes	CR	<p><b>CONTROL: all DIP switch Settings</b> A value is required to be read out from RDF880KN/NF for the current DIP SW setting. Refer to dip switch position selection. 1 - UFH only; 2 - VRF only; 3 - both VRF &amp; UFH</p>										
56	Sub application: Preselection	counter pulses (0..255)	5.010	1 byte	CRT	<p><b>CONTROL: use for DIP switch Setting → 3: BOTH</b> It is a command to send out for the current sub selection below within a combined UFH and VRF/VRF unit. 1 - UFH only; 2 - VRF only; 3 - both VRF &amp; UFH</p>										
57	Sub application: State	counter pulses (0..255)	5.010	1 byte	CWU	<p><b>STATUS: use for DIP switch Setting → 3: BOTH</b> A value is received from a KNX control device for the current sub selection below within a combined UFH and VRF/VRF unit. 1 - UFH only; 2 - VRF only; 3 - both VRF &amp; UFH</p>										

**C: Communication; R: Read; W: Write; T: Transmission; U: Update**

Notes: The current RDF880KN/NF is based on a Floor Heating Controller with additional VRF HMI. Therefore, to turn on the controller, effectively, it is to turn on the UFH application.

- In a UFH application selected via DIP switch setting or remote configuration, the operations are identical to RDD810KN/NF while all VRF relevant S-mode objects are invisible.
- In a VRF application selected via DIP switch setting or remote configuration, UFH application will not be turned ON remotely via any KNX control devices or locally via HMI.
- In a combined application (both UFH and VRF) selected via DIP switch setting or remote configuration, the object Sub Application (56, 57) can be used by any KNX control devices to do remote selection of applications (UFH only, VRF only or UFH & VRF) required. But the objects: Time Switch/Schedule (12, 13, 14, and 15) or ECO mode (10, 18) via any KNX control devices remotely will turn on/off both VRF and UFH. Therefore, it is not recommended to use objects: Time Switch/Schedule (12, 13, 14, and 15) or ECO mode (10, 18).

\*) If object Fan operation (33) is used together with object Fan speed (36), the value "0 – Auto" of object Fan speed (36) cannot be used. If these two objects are not used together, the value "0 – Auto" can be used.

## Disposal







---



The device is considered electrical and electronic equipment for disposal in terms of the applicable European Directive and may not be disposed of as domestic garbage.

- Dispose of the device through channels provided for this purpose.
- Comply with all local and currently applicable laws and regulations.

## Technical data

 Power supply	Rated voltage	AC 230 V
	Overvoltage category	III
	Frequency	50/60 Hz
	Power consumption	Max. 6.0 VA / 2.1 W
Caution 	No internal fuse. External preliminary protection with max C 10 A circuit breaker required in all cases.	
Outputs	Control output Q11, Q12, Q14 (SPDT)	AC 24...230 V
	Rating Min, Max resistive (inductive)	Min. 10 mA, Max. 5(2) A
Caution 	No internal fuse. External preliminary protection with max C 10 A circuit breakers in the supply line (Q11) required in all cases.	
Inputs	Multifunctional input X1-M/X2-M	
	Temperature sensor input:	
	Type	See "Equipment combinations"
	Temperature range	0...49 °C
	Cable length	Max. 80 m
	Digital input:	
	Operating action	Selectable (NO / NC)
	Contact sensing	SELV DC 0...5 V / Max. 5 mA
	Parallel connection of several thermostats for one switch	Max. 20 thermostats per switch
	Insulation against mains voltage (SELV)	4 kV, reinforced insulation
Function of inputs:	Selectable	
External temperature sensor, window contact, fault contact, monitoring input	X1: P38 X2: P40	
KNX bus	Interface type	KNX, TP1-64 (electrically isolated)
	Bus current	5 mA
	Bus topology: See KNX manual (Reference documentation, see below)	
Operational data	Switching differential, adjustable	
	Heating mode (P30)	1 K (0.5...6 K)
	Setpoint setting and range	
	 Comfort (P08)	21 °C (5...40 °C)
	 Economy (P11)	15 °C (OFF, 5...40 °C)
	 Protection (P65)	8 °C (OFF, 5...40 °C)
	Multifunctional input X1/X2	Selectable 0, 1, 3, 6, 7, 8
	Input X1 default value (P38)	0 (no function)
	Input X2 default value (P40)	0 (no function)
	Built-in room temperature sensor	
	Measuring range	0...49 °C
	Accuracy at 25 °C	< ± 0.5 K
	Temperature calibration range	± 5.0 K
	Settings and display resolution	
	Setpoints	0.5 °C
	Current temperature value displayed	0.5 °C
	Built-in room humidity sensor	
	Measuring range	0...100%
Accuracy at 25 °C	± 5% r.h.	
Humidity calibration range	± 20%	
Settings and display resolution		
Display resolution	1% r.h.	

Environmental conditions	Storage	As per IEC 60721-3-1	
	Climatic conditions	Class 1K3	
	Transport	As per IEC 60721-3-2	
	Climatic conditions	Class 2K3	
Standards and directives	Operation	As per IEC 60721-3-3	
	Climatic conditions	Class 3K5 <sup>1)</sup>	
	EU Conformity (CE)	A6V11350285 <sup>1)</sup>	
	Electronic control type	2.B (micro-disconnection on operation)	
	 RCM conformity to EMC emission standard	A6V11350287	
	Safety class	II as per EN 60730	
	Pollution class	Normal	
	Degree of protection of housing	IP 30 as per EN 60529	
Environmental compatibility	Housing flammability class according to UL94	V-0	
	The product environmental declaration E3174en contains data on environmentally compatible product design and assessments (RoHS compliance, materials composition, packaging, environmental benefit, disposal).		
Eco design and labelling directives	Based on EU Regulation 813/2013 (Eco design directive) and 811/2013 (Labelling directive) concerning space heaters, combination heaters, the following class apply:		
General	- Application with On/Off operation of a heater	Class I          value 1%	
	Connection terminals	Solid wires or prepared stranded wires 1 x 0.4...1.5 mm <sup>2</sup> or 2 x for KNX cables/sensor	
	Minimal wiring cross section on L, N, Qxx	Min 1.5 mm <sup>2</sup>	
	Housing front color	Ivory White	
	Weight without / with packaging	0.145 kg / 0.245 kg	
	<sup>1)</sup> The documents can be downloaded from <a href="http://siemens.com/bt/download">http://siemens.com/bt/download</a> .		
<sup>1)</sup> No condensation is allowed.			
<b>Reference documentation</b>	Handbook for Home and Building Control - Basic Principles ( <a href="https://my.knx.org/shop/product?language=en&amp;product_type_category=books&amp;product_type=handbook">https://my.knx.org/shop/product?language=en&amp;product_type_category=books&amp;product_type=handbook</a> )		
	Synco	CE1P3127 Communication via the KNX bus for Synco 700, 900 and RXB/RXL Basic documentation	
	Desigo	CM1Y9775 Desigo RXB integration – S-mode	
		CM1Y9776 Desigo RXB / RXL integration – individual addressing	
		CM1Y9777 Third-party integration	
		CM1Y9778 Synco integration	
		CM1Y9779 Working with ETS	

## Connection terminals

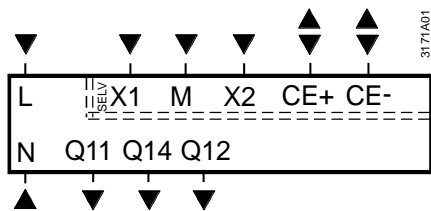

L, N	Operating voltage AC 230 V
Q11, Q12	NC contact (for NO valves)
Q11, Q14	NO contact (for NC valves)
X1, X2	Multifunctional input for temperature sensor or potential-free switch
	Factory setting:
	– X1 = Window contact
	– X2 = External sensor
	(function can be selected via parameter P38 / P40)
M	Measuring neutral for sensor and switch
CE+	KNX data +
CE-	KNX data -

## Connection diagrams

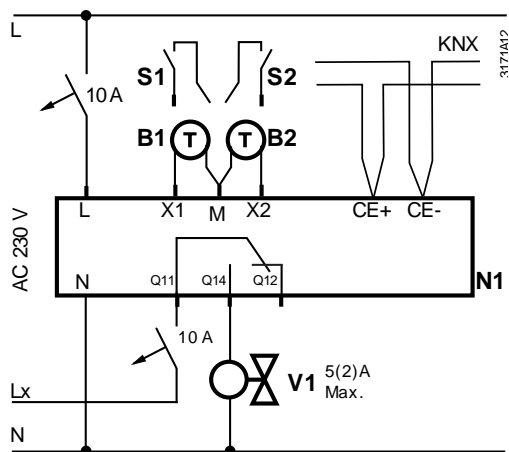

N1	Room thermostat
V1	Valve actuator
Lx	AC 24...230 V
S1, S2	Switch (keycard, window contact, presence detector, etc.)
B1, B2	Temperature sensor (return air temperature, external room temperature, changeover sensor, etc.)
CE+	KNX data +
CE-	KNX data -

Dimensions (mm)

RDF880KN/NF  
for square conduit  
boxes only

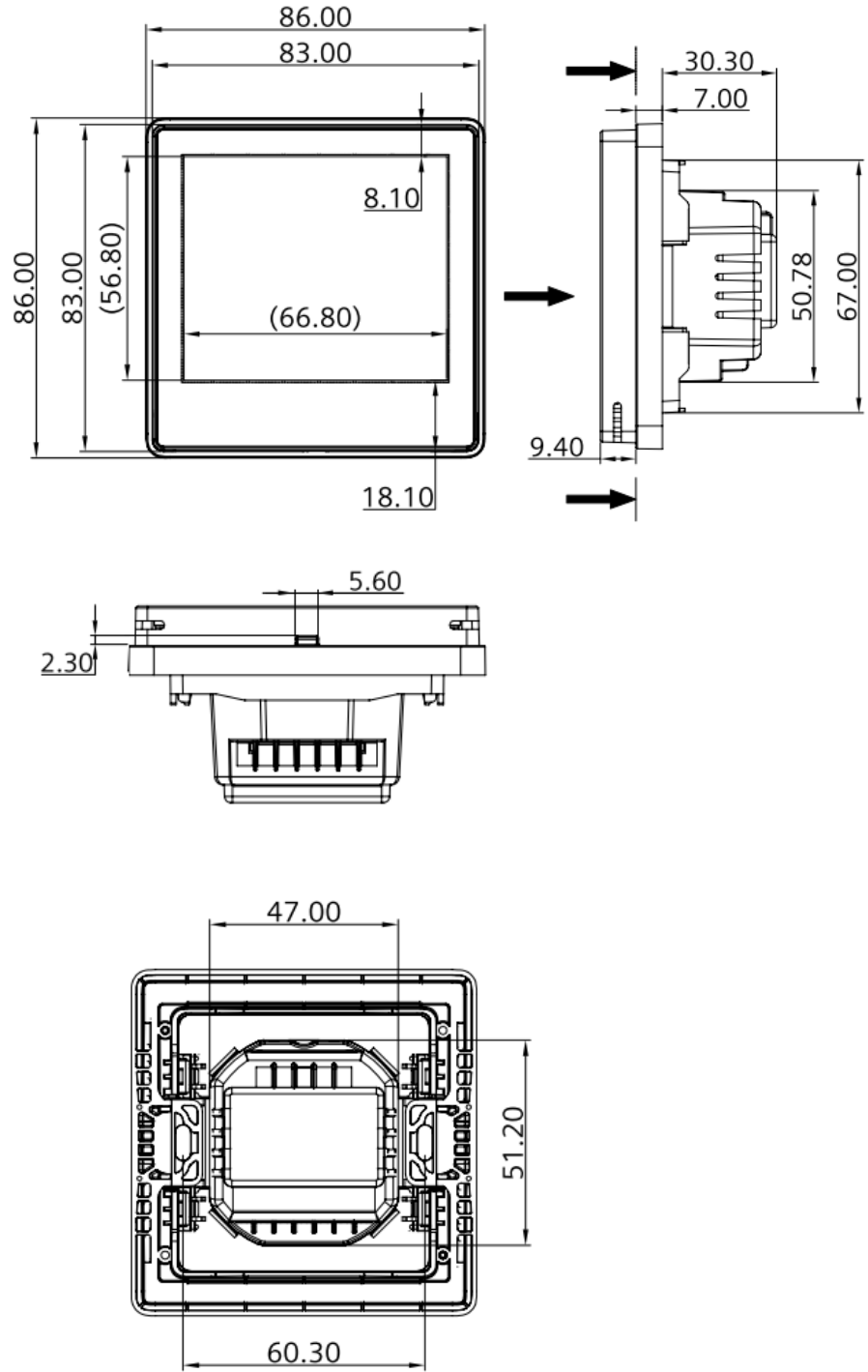

**ARG800.1 single  
mounting frame for  
RDF880KN/NF**

