

OpenAir™

## Air damper actuators for railway vehicles

GD..14..1E/RW



### Electronic motor driven actuators for open-close and three-position control

- Nominal torque 5 Nm
- Runtime 30 s / 90 s
- Rotary angle 0...90°
- Connection cables railway specific
- Feedback potentiometer
- Adjustable auxiliary switches
- Degree of protection IP54
- Printed circuit board, coated

Air damper actuators in difficult operational conditions; they meet the main requirements for:

- EN 50155 (Railway applications - Electronic equipment used on rolling stock)
- EN 45545 (Railway applications - Fire protection on railway vehicles)
- EN 61373 (Railway applications - Rolling stock equipment - Shock and vibration tests).

The damper actuators are expressly suitable for air conditioning units and air distribution systems for railway vehicles.

- For damper areas up to 0.8 m<sup>2</sup>
- Suitable for use with open-close- or three-position controllers.
- We recommend a minimum pulse length of 500 ms on rotary actuators operated with 3-point control to ensure continuous and accurate operation.

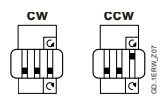
Function	Description
Control type	Open-close-( SPST / SPDT) or three-position
Rotary direction	Clockwise / counter-clockwise, selectable with switch. With no power applied, the actuator remains in the respective position. 
Position indication: Mechanical	Rotary angle position indication by using a position indicator.
Position indication: Electrical	The feedback potentiometer can be connected to external voltage to indicate the position.
Auxiliary switch	The switching points for auxiliary switches A and B can be set independent of each other in increments of 5° within 0° to 90°.
Manual adjustment	The actuator can be manually adjusted by pressing the gear train disengagement button.
Rotary angle limitation	The rotary angle of the shaft adapter can be limited mechanically with a set screw.

## Housing

The housing consists essentially of flame retardant, non brominated, non chlorinated glass fibre reinforced plastic.

## Actuator motor / Gears

Brushless, robust DC motors ensure reliable operation regardless of load. The damper actuators do not require an end position switch, are overload proof, and remain in place up on reaching the end stop.

The gears are maintenance free and low noise.

Type	Stock no.	Operating voltage	Runtime [s]	Feedback potentiometer 5 kΩ	Auxiliary switch (adjustable)	Weight [g]	Cable length [m]	Rotary direction switch
GDD141.1E/RW	S55499-D403	DC 24 V $\equiv$	30	–	–	570	0.9	yes
GDD142.1E/RW	S55499-D405		30	yes	–	640		
GDD146.1E/RW	S55499-D404		30	–	2	750		
GDD146.1G/RW	S55499-D274		30	–	2	1100	3.0	
GDA141.1E/RW	S55499-D212		90	–	–	570	0.9	
GDA142.1E/RW	S55499-D214		90	yes	–	640		
GDA146.1E/RW	S55499-D213		90	–	2	750		

## Accessories

Type	Description	Use
ASK78.6	Centering insert, square profile 8 mm	To center a shaft with square profile 8 x 8 mm in the coupling bushing of the actuator.
ASK78.7	Centering insert, square profile 10 mm	To center a shaft with square profile 10 x 10 mm in the coupling bushing of the actuator.
ASK78.9	Centering insert, round 10 mm	To center a shaft with round dia. 10 mm in the coupling bushing of the actuator.
ASK78.10	Centering insert, round 12 mm	To center a shaft with dia. 12 mm in the coupling bushing of the actuator.

Topic	Title	Document ID
Data sheet	Air damper actuators for railway vehicles	A6V10636280_enAP_b
Technical basics	Rotary damper actuators without spring return GD..E	A6V10636139_en--_a
Mounting instructions	GD..1E/RW, GD..1G/RW, GL..1E/RW	A6V10636275_----_a

Related documents such as environmental declarations, CE declarations, etc., can be downloaded at the following Internet address:

<http://siemens.com/bt/download>

## Safety

	<p><b>⚠ Caution</b></p>
	<p><b>National safety regulations</b></p> <p>Failure to comply with national safety regulations may result in personal injury and property damage.</p> <ul style="list-style-type: none"> <li>• Observe national provisions and comply with the appropriate safety regulations.</li> <li>• Use only properly trained technicians for mounting, commissioning, and servicing.</li> </ul>

**Potentiometer and auxiliary switches**

Potentiometer and auxiliary switches cannot be added in the field. For this reason, order the type that includes the required options.

**Installation**

	<p><b>⚠ WARNING</b></p>
	<p><b>No internal line protection for supply lines to external consumers</b>                  Risk of fire and injury due to short-circuits</p> <ul style="list-style-type: none"> <li>Adapt the line diameters as per local regulations to the rated value of the installed fuse.</li> </ul>

**Maintenance**

The actuators GD..14..1E/RW are maintenance-free.

**Disposal**

	<p>The device is considered electrical and electronic equipment for disposal in terms of the applicable European Directive and may not be disposed of as domestic garbage.</p> <ul style="list-style-type: none"> <li>Dispose of the device through channels provided for this purpose.</li> <li>Comply with all local and currently applicable laws and regulations..</li> </ul>
---	---

Power supply		GDD1..1E/RW	GDA1..1E/RW
Operating voltage		DC 24...45 V $\approx$ +25 % / -30 % (16.8...56.3 V $\approx$ ) <sup>1)</sup>	
Power consumption	Running	1.5 W	1.0 W
	Holding	0.5 W	0.5 W

Functional data		GDD1..1E/RW	GDA1..1E/RW
Nominal torque		5 Nm	
Maximum torque (blocked)		7 Nm	
Nominal rotary angle		90°	
Max. rotary angle		95° $\pm$ 2°	
Runtime for 90° rotary angle		30 s	90 s
Actuator sound power level		32 dB(A)	30 dB(A)
Feedback potentiometer		GD..142.1E/RW (only):	
Change of resistance (wires P1-P2)		0...5000 $\Omega$	
Load		<0,25 W	

Auxiliary switches (GD..146.1E/RW only)	
Contact rating	4 A resistive, 2 A inductive, min. 10 mA @ DC 30 V $\approx$ 0.8 A resistive, 0.5 A inductive, min. 10 mA @ DC 60 V $\approx$
Switching voltage	DC 12...60 V $\approx$
Switching range for auxiliary switches	5°...90°
Setting increments	5°

<sup>1)</sup> C-UL: Permitted only to DC 30 V  $\approx$

<b>Wiring connections (specific for railway vehicles)</b>	
Cable length	0.9 m (GDD146.1G/RW: 3.0 m)
Cross-section	0.75 mm <sup>2</sup>
<b>Degree of protection</b>	
Insulation class GD..142.1E/RW (Feedback potentiometer) GD..146.1E/RW (Auxiliary switches)	As per EN 60730 III III
Housing protection	IP 54 as per EN 60529
<b>Environmental conditions</b>	
Temperature	-40...+70 °C
Overtemperature (max.10 min / 15 °C)	...+85 °C
Humidity	<95 % r.F.
Condensation	permitted
<b>Standards, directives and approvals</b>	
Product standard	EN60730 Part 2-14 / Particular requirements for electric actuators
Railway applications	EN 50155 Railway applications - Electronic equipment used on rolling stock  EN 61373 Shock and vibration  EN 45545-2 Fire prevention in railway vehicles
Electromagnetic compatibility (Application area)	For railway applications Residential, commercial, light-industrial and industrial environments
EU Conformity (CE) GDD1..1E/RW GDA1..1E/RW	A5W00026942 <sup>2)</sup> A5W00026943 <sup>2)</sup>
RCM Conformity GDD1..1E/RW GDA1..1E/RW	A5W00026946 <sup>2)</sup> A5W00026947 <sup>2)</sup>
EAC Conformity	Eurasian conformity
UL	UL as per UL 60730 <a href="http://ul.com/database">http://ul.com/database</a> cUL as per CSA-C22.2 No. 24-93
<b>Environmental compatibility</b>	
The product environmental declaration A5W00026066 <sup>2)</sup> contains data on environmentally compatible product design and assessments (RoHS compliance, materials composition, packaging, environmental benefit, disposal).	
<b>Dimensions</b>	
Actuator W x H x D	see „Dimensions“, p. 7
Damper shaft: – square Min. shaft length Shaft hardness – round Min. shaft length Shaft hardness	6...12.8 mm 20 mm 300 HV 8...16 mm 30 mm 300 HV
<b>Weight</b>	
Without packaging	see „Type summary“, p. 3

<sup>2)</sup> The documents can be downloaded from <http://siemens.com/bt/download>.

## Internal Diagrams

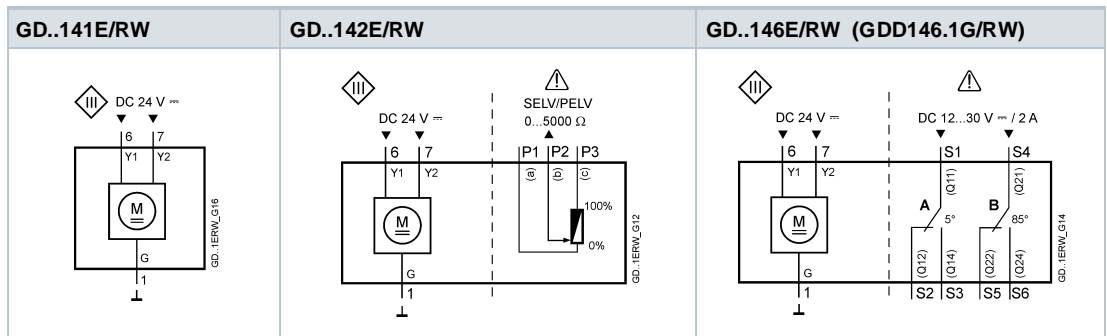

## Connection diagrams

### Control

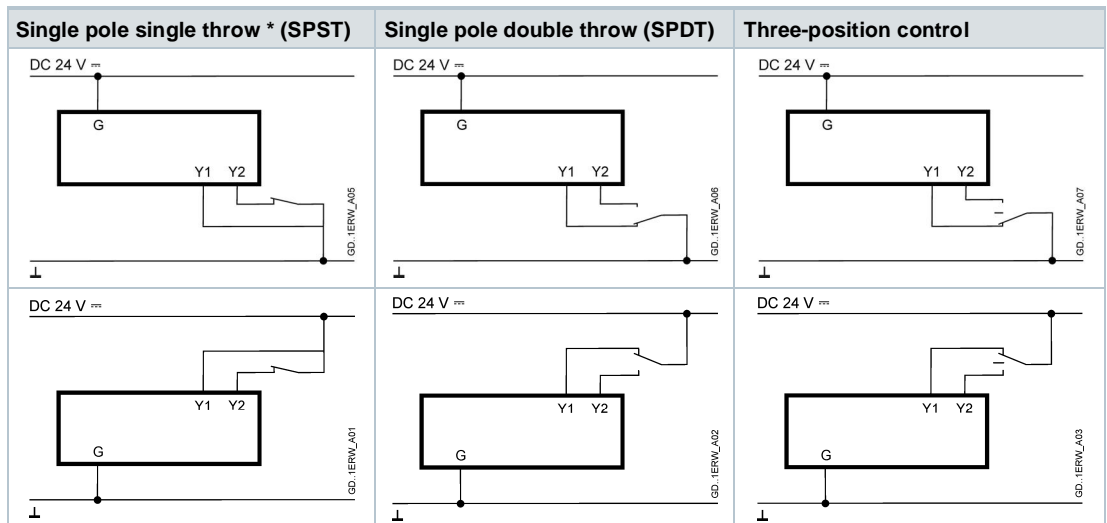

\* Forced control (Y1+Y2 are permanently under current → Actuator drives to the 0 position)

### Cable labeling

Connection	Code	No	Color	Abbreviation	Meaning
DC 24 V = Actuators	G	1	red	RD	System potential DC 24 V =
	Y1	6	purple	VT	Positioning signal DC 24 V, "clockwise"
	Y2	7	orange	OG	Positioning signal DC 24 V, "counter-clockwise"
Feedback potentiometer	a	P1	white/red	WHRD	Potentiometer 0...100 % (P1-P2)
	b	P2	white/blue	WHBU	Potentiometer pick-off
	c	P3	white/pink	WHPK	Potentiometer 100...0 % (P3-P2)
Auxiliary switch	Q11	S1	grey/red	GYRD	Switch A input
	Q12	S2	grey/blue	GYBU	Switch A normally closed contact
	Q14	S3	grey/pink	GYPK	Switch A normally open contact
	Q21	S4	black/red	BKRD	Switch B input
	Q22	S5	black/blue	BKBU	Switch B normally closed contact
	Q24	S6	black/pink	BKPK	Switch B normally open contact

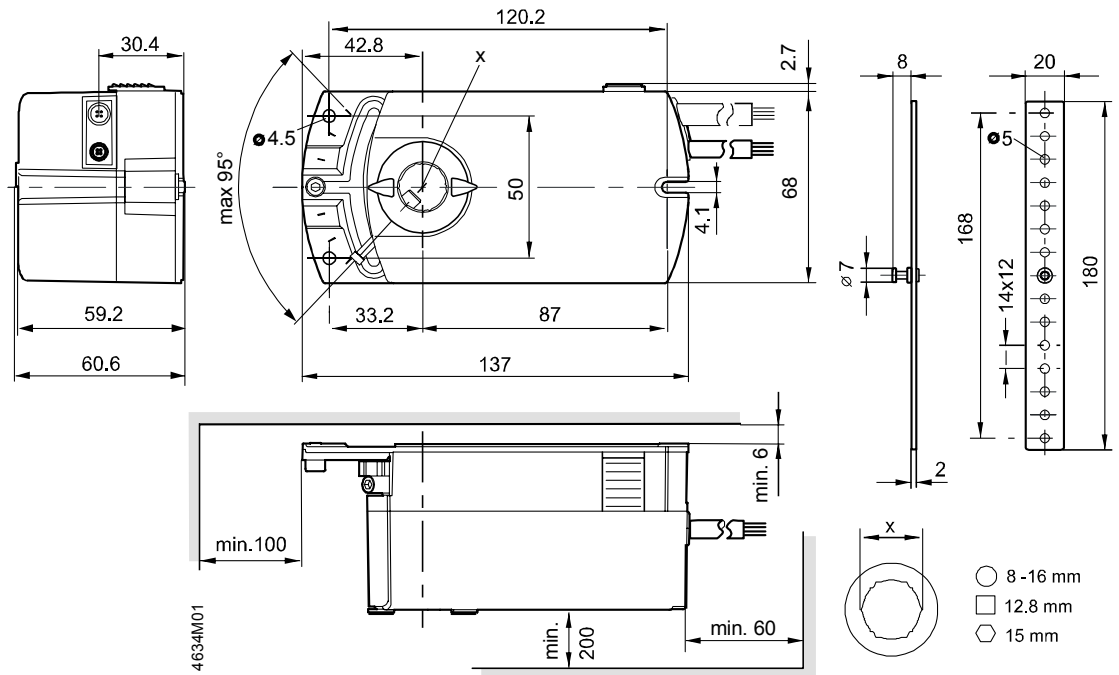

Dimensions in mm

Issued by  
Siemens Switzerland Ltd  
Building Technologies Division  
International Headquarters  
Theilerstrasse 1a  
6301 Zug  
Switzerland  
Tel. +41 58-724 24 24  
[www.siemens.com/buildingtechnologies](http://www.siemens.com/buildingtechnologies)

© Siemens Switzerland Ltd, 2016-2018  
Technical specifications and availability subject to change without notice.

---

Document ID    A6V10636280\_enAP\_c  
Issue            2018-04-09