

en Mounting instructions
 de Montageanleitung
 fr Instructions de montage
 zh-CN 安装指南

Symaro™
 QSA27..

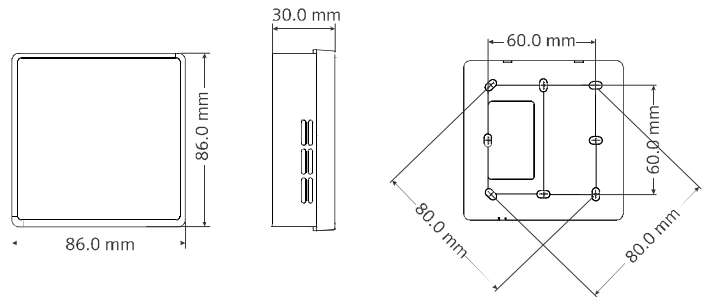

ABV11160930A00

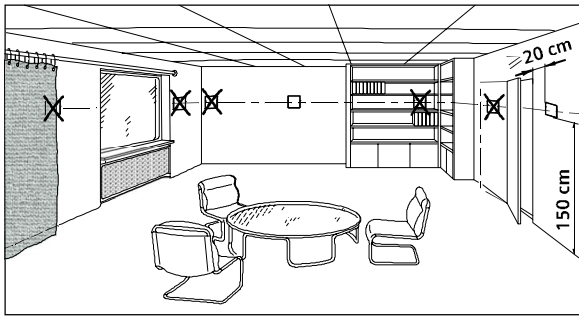
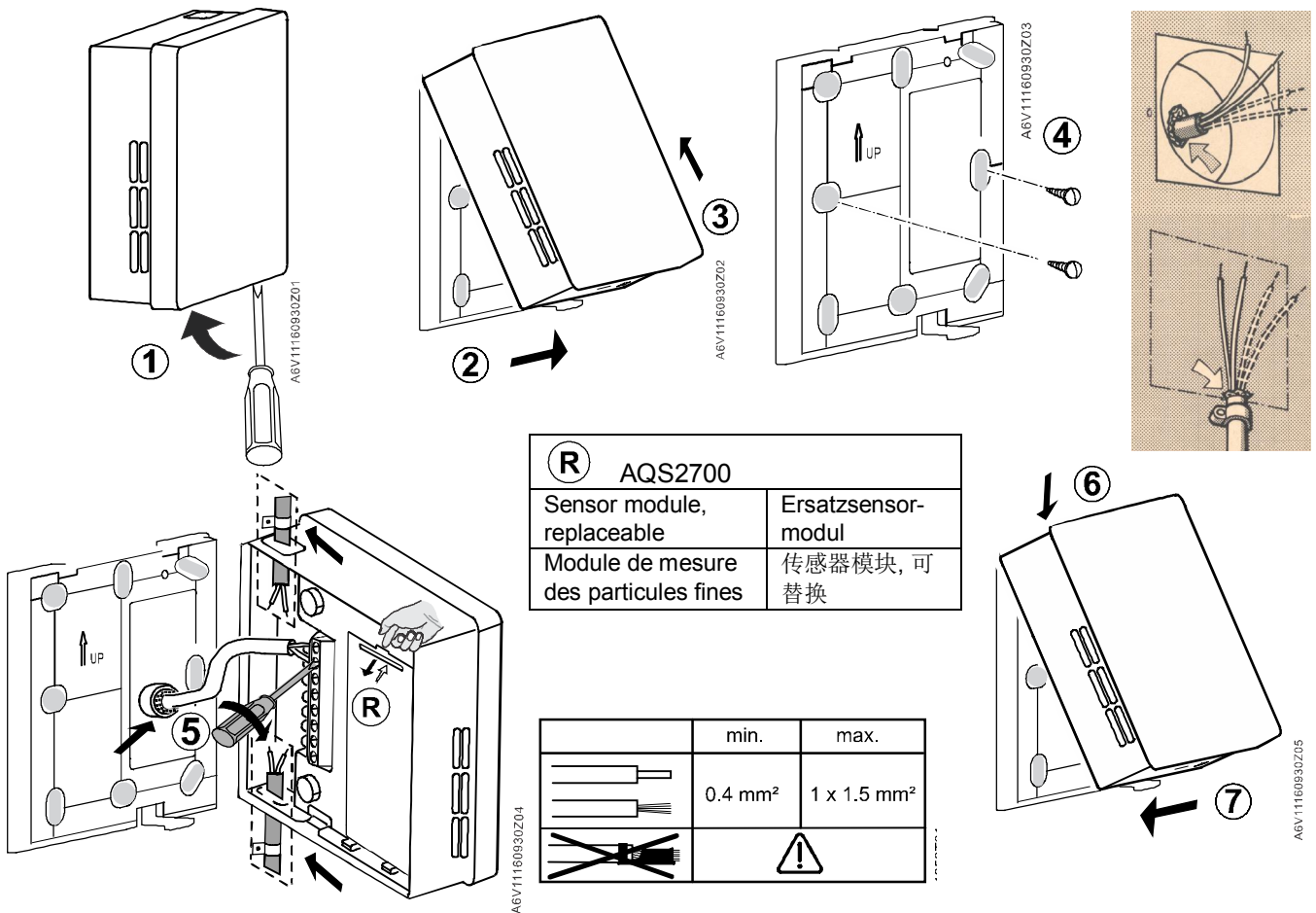

(R) AQS2700	
Sensor module, replaceable	Ersatzsensor-modul
Module de mesure des particules fines	传感器模块, 可替换

	min.	max.
	0.4 mm ²	1 x 1.5 mm ²
	⚠	

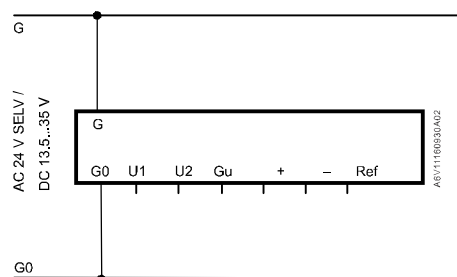
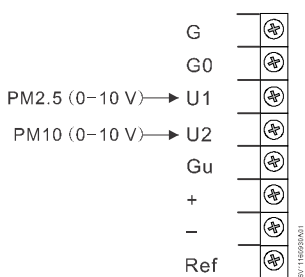

- 1) www.siemens.com/HIT (HIT start center)
- 2) "QSA27.."
- 3) (doc)



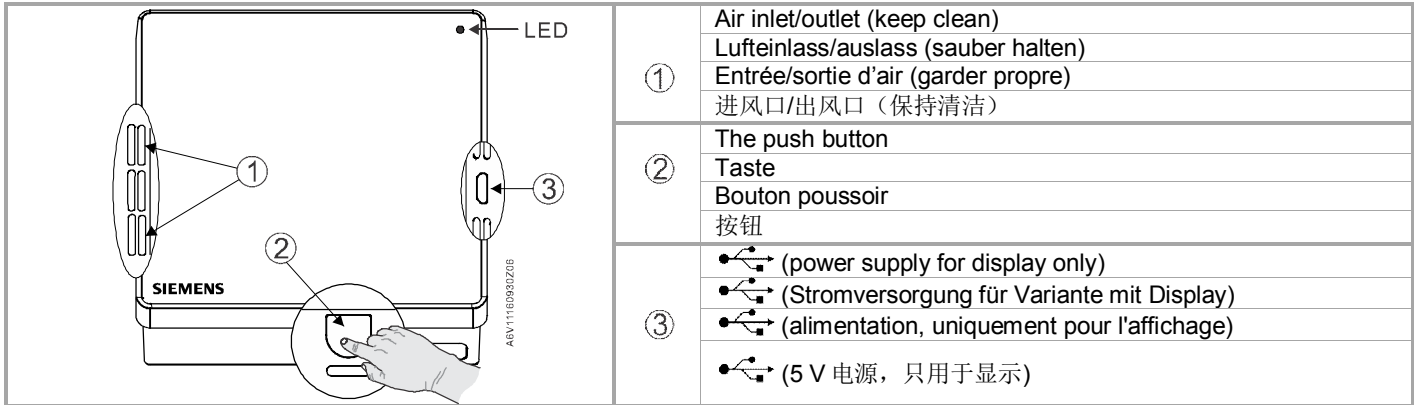

①	Air inlet/outlet (keep clean) Lufteinlass/auslass (sauber halten) Entrée/sortie d'air (garder propre) 进风口/出风口 (保持清洁)
②	The push button Taste Bouton poussoir 按钮
③	<ul style="list-style-type: none"> • (power supply for display only) • (Stromversorgung für Variante mit Display) • (alimentation, uniquement pour l'affichage) • (5 V 电源, 只用于显示)



Press the button for	LED	Action	Tastendruck	LED	Aktion
1...5 s	Constant red	Keep pressing	1...5 s	Rot dauerhaft	Taste gedrückt halten
5...10 s	LED off	Release the button to configure the device via the Climatix™ controller	5...10 s	LED aus	Taste loslassen um das Gerät vom Climatix™ Regler zu konfigurieren
10...13 s	Flash yellow	Release the button to reset the device	10...13 s	Gelb blinkend	Taste loslassen um einen Reset durchzuführen
>13 s	Returns to the initial status	Resetting cancelled	>13 s	Rückkehr zum Initialzustand	Reset abgebrochen
Appuyez sur le bouton	LED	Action	按住按钮	LED	操作
1...5 s	Rouge constant	Pas d'action	1...5 秒	红灯常亮	持续按
5...10 s	LED éteinte	Relâcher le bouton pour configurer le produit via le contrôleur Climatix™	5...10 秒	LED 关闭	松开按钮, 通过 Climatix™ 控制器对设备进行配置
10...13 s	Jaune clignotant	Relâcher le bouton pour remettre à l'état initial	10...13 秒	黄灯闪烁	松开按钮, 对设备进行重置
>13 s	Retour au mode initial	Remise à l'état initial annulée	>13 秒	回到之前的状态	重置取消

LED

Color	Pattern	Description
Green	Permanent on	Working properly, and Modbus being configured
Yellow	Permanent on	Working properly, and Modbus with factory settings
Red	Permanent on	Error 1, replace sensor module
Red	Flashing (0.5 s on / 0.5 s off)	Error 2, communication error
Farbe	Muster	Beschreibung
Grün	leuchtet	Fehlerfrei und Modbus wird konfiguriert
Gelb	leuchtet	Fehlerfrei und Modbus mit Werkseinstellungen
Rot	leuchtet	Fehler 1, Sensormodul ersetzen
Rot	blinkt (0.5 s ein / 0.5 s aus)	Fehler 2, Verbindungsfehler
Couleur	Etat	Description
Vert	Constamment allumée	Fonctionnement normal; communication Modbus étant configurée
Jaune	Constamment allumée	Fonctionnement normal; communication Modbus avec les réglages d'usine
Rouge	Constamment allumée	Erreur 1, remplacer le module de sonde
Rouge	Clignotant	Erreur 2, erreur de communication
颜色	类型	描述
绿灯	常亮	设备正常运行, 并且 Modbus 已配置
黄灯	常亮	设备正常运行, 但 Modbus 为出厂设置
红灯	常亮	错误 1, 更换传感元件
红灯	闪烁 (0.5 秒亮 / 0.5 秒暗)	错误 2, 通讯错误

	<p>② The push button Taste Bouton poussoir 按钮</p> <p>③ Indicates the short press Kurzer Tastendruck Appui court 表示短按按钮</p> <p>④ Indicates the long press & the pressing time Langer Tastendruck Appui long 表示长按按钮及持续时间</p> <p>⑤ Indicates the action executed by pressing the button Beschreibt die jeweilige Aktion Indique l'action exécutée en appuyant sur le bouton 表示执行的任务</p> <p>⑥ Proximate sensor (keep clean) Annäherungssensor (sauber halten) Capteur à proximité (garder propre) 接近传感器 (保持清洁)</p>
<p>①</p> <ul style="list-style-type: none"> ➔ (power supply for display only) ➔ (Stromversorgung für Variante mit Display) ➔ (alimentation, uniquement pour l'affichage) ➔ (5 V 电源, 只用于显示) 	

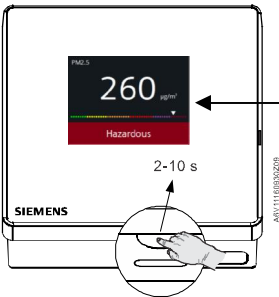
<p>1. Select language / Auswählen der Sprache / Sélectionner la langue / 选择语言</p>	<p>2. Select AQI class / Auswählen der AQI Klasse / Sélectionner la classe IQA / 选择 AQI 等级</p>	
		<p>Press the button according to indication for each action.</p>
<p>3. Normal display. Short press to user manual page Standard Display. Kurzer Tastendruck für die Bedienungsanleitung Affichage normal. Appui court pour afficher le QR-code 标准显示页面。短按按钮进入下载用户手册页面。</p>	<p>4. Scan the QR-code to get more usage info. Scannen des QR-Code für weitere Informationen. Scanner le QR-code pour obtenir le manuel d'utilisation. 扫描二维码下载用户手册</p>	<p>Taste für angegebene Aktionen drücken.</p>
		<p>Appuyez sur le bouton selon l'indication pour chaque action.</p> <p>按提示, 按键以执行操作。</p>

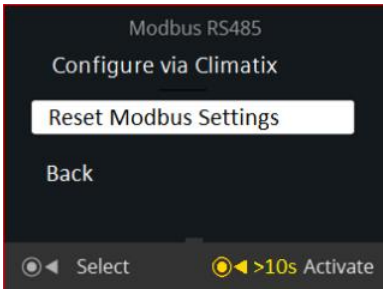
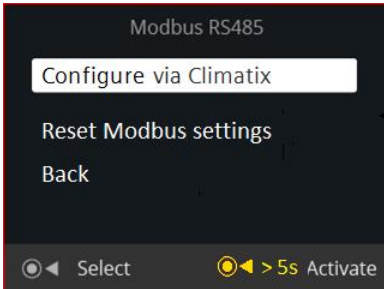
<p>1. 2-10s, long press / 2-10s gedrückt halten / 2-10s, Appui long / 长按按钮 2-10 秒</p>	<p>2. Modbus display / Modbus Anzeige / Ecran Modbus / Modbus 显示</p>	 <p>Press the button according to indication in manual bar for each action.</p> <p>Taste für angegebene Aktionen drücken.</p> <p>Appuyez sur le bouton selon l'indication pour chaque action.</p> <p>按提示，按键以执行操作。</p>
		
<p>4. Factory reset if needed / Werkseinstellungen / Retour aux réglages d'usine si nécessaire/ 恢复出厂设置</p>	<p>3. Configure via Climatix / Konfiguration durch Climatix/ Configurez via Climatix/ Climatix 一键配置功能</p>	
		

<p>en QSA27.. – Parameters, Modbus RS485 fr QSA27.. – Paramètres, Modbus RS485</p>	<p>de QSA27.. – Parameter, Modbus RS485 zh-CN QSA27.. – 参数, Modbus RS485</p>
--	--

en		Name	Range / Enumeration	Default	Registers	R/W	de		Name	Bereich	Voreinstellung	Register	R/W
Configurable	Address	1...247		1	764	RW	Configurable	Adresse	1...247	1	764	RW	
	Baud rate (bps)	1 = 9600 / 2 = 19200 / 3 = 38400 / 4 = 57600	19200	765	RW	Baudrate (bps)		1 = 9600 / 2 = 19200 / 3 = 38400 / 4 = 57600	19200	765	RW		
	Transmission format	0 = 1-8-E-1 / 1 = 1-8-O-1 / 2 = 1-8-N-1 / 3 = 1-8-N-2	0	766	RW	Transmissionsformat		0 = 1-8-E-1 / 1 = 1-8-O-1 / 2 = 1-8-N-1 / 3 = 1-8-N-2	0	766	RW		
Basic	Parity	Even / Odd / No	Even				Basic	Parität	Gerade / Ungerade / Keine	Gerade			
	Stop bits	1 / 2	1			Stoppbits		1 / 2	1				
	Data	8 bits (0-255)				Daten		8 bits (0-255)					
	Identify	Slave				Identify		Slave					
	Cable length	Max:1000m; Recommend: <600m					Kabellänge	Empfohlen: <600m					
fr		Nom	Intervalle/énumération	Défaut	Registres	R/W	zh-CN		名称	参数范围	默认值	寄存器	R/W
Configurable	Adresse	1...247		1	764	RW	可配置参数	地址	1...247	1	764	RW	
	Vitesse de transmission (bps)	1 = 9600 / 2 = 19200 / 3 = 38400 / 4 = 57600	19200	765	RW	波特率 (bps)		1 = 9600 / 2 = 19200 / 3 = 38400 / 4 = 57600	19200	765	RW		
	Format de transmission	0 = 1-8-E-1 / 1 = 1-8-O-1 / 2 = 1-8-N-1 / 3 = 1-8-N-2	0	766	RW	传输格式		0 = 1-8-E-1 / 1 = 1-8-O-1 / 2 = 1-8-N-1 / 3 = 1-8-N-2	0	766	RW		
Basic	Parité	Paire / Impaire / Sans	Paire				基本信息	奇偶校验	偶 / 奇 / 无	偶			
	Bits d'arrêt	1 / 2	1			停止位		1 / 2	1				
	Données	8 bits (0-255)				数字位		8 bits (0-255)					
	Identification	Slave				设备类型		从站					
	Longueur de câble	Max:1000m; recommandée : <600m					通讯电缆长度	最长 1000m; 建议 < 600m					