

# SIEMENS

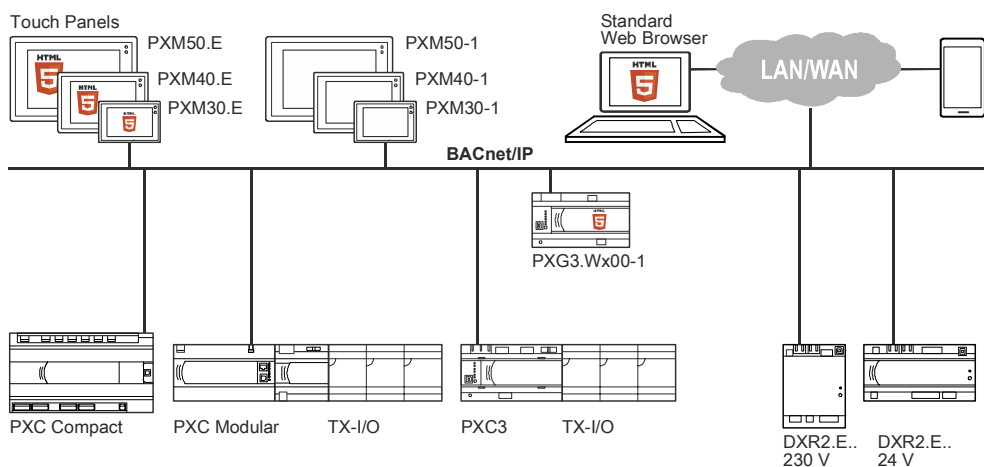

## Desigo™

## Desigo Control Point

## Basic Documentation

## Edition notice

Technical specifications and availability subject to change without notice.

This document may not be reproduced, disseminated to third parties or processed and its contents may not be used or disclosed without express permission. Non-compliance shall result in compensation for damages. All rights, including those resulting from a successful patent application and registration of a utility model or design patent, are reserved.

Edition: 2020-04-07

Document ID: A6V11170804\_en--\_j

© Siemens Switzerland Ltd, 2019

## Trademarks

The trademarks used in this document are listed together with their legal owners in this section. The use of these trademarks is subject to international and national statutory provisions.

Desigo® and Desigo® CC™ are registered trademarks of Siemens Schweiz AG.

BACnet is a trademark of American National Standard (ANSI/ASHRAE 135-1995).

Chrome and the Chrome logo are trademarks of Google LLC.

Firefox is a registered trademark of Mozilla Foundation.

Internet Explorer is a trademark of Microsoft Corporation.

Oracle and Java are trademarks or registered trademarks of Oracle America, Inc.



Further to the notes in this section, and to facilitate the reading of the text, these trademarks will not be indicated elsewhere in the text by use of symbols, such as ® or ™.

# Contents

<b>1</b>	<b>About this manual.....</b>	<b>5</b>
1.1	Scope .....	5
1.2	Target audience.....	5
1.3	Terms .....	5
1.4	Documentation.....	6
<b>2</b>	<b>Cyber security disclaimer .....</b>	<b>7</b>
<b>3</b>	<b>Safety notes .....</b>	<b>8</b>
<b>4</b>	<b>Overview.....</b>	<b>12</b>
4.1	Devices.....	12
4.2	Functions.....	13
4.3	Commissioning .....	14
4.4	Engineering.....	14
<b>5</b>	<b>Functions in detail .....</b>	<b>15</b>
5.1	User profile .....	15
5.2	Access levels .....	16
<b>6</b>	<b>System limits .....</b>	<b>18</b>
6.1	Device-related limits.....	18
6.2	Memory management .....	18
6.3	Graphics-based operation .....	19
6.4	Technical limits .....	20
6.5	LonWorks limits.....	21
6.6	Limits for MS/TP .....	21
6.7	Supported BACnet objects .....	21
<b>7</b>	<b>Compatibility.....</b>	<b>22</b>
7.1	Compatibility with earlier systems.....	22
7.2	Compatibility with earlier devices.....	22
<b>8</b>	<b>Supported browsers.....</b>	<b>24</b>
<b>9</b>	<b>Planning (hardware) .....</b>	<b>25</b>
9.1	IT security .....	25
9.2	Ports for remote access .....	25
9.3	Topologies .....	26
9.4	Power requirements.....	28
9.4.1	Power consumption per device.....	28
9.4.2	Transformer sizing AC 24 V.....	29
9.4.3	Power requirements for DC 24 V.....	30
9.5	Ethernet.....	31
9.5.1	Cable .....	32
9.5.2	Power over Ethernet (PoE) PoE .....	32
<b>10</b>	<b>Mounting .....</b>	<b>34</b>
10.1	Touch panels PXM.....	34
10.2	Web server .....	36
<b>11</b>	<b>Wiring .....</b>	<b>37</b>

11.1	Power supply AC 230 V .....	38
11.2	Power supply DC 24 V .....	38
12	<b>Disposal</b> .....	<b>39</b>
13	<b>Appendix - Supported BACnet objects</b> .....	<b>40</b>

# 1 About this manual

## 1.1 Scope

This manual describes the technical fundamentals of Desigo Control Point:  
Devices, topologies, functions, system limits, power supply, wiring, mounting.

## 1.2 Target audience

Technical specialists responsible for planning, commissioning, and maintaining Desigo Control Point.  
Basic knowledge of building automation and control is required to understand this document and successfully implement a project.

## 1.3 Terms

Term	Definition
ABT-SSA	Setup & Service Application included in Desigo Control Point. Mainly intended for commissioning, service and other more advanced tasks. Also provides a generic data point list to operate all supported BACnet objects and properties of the assigned devices.
automation station	Primarily controls equipment and plants. An automation station samples and processes field data, initiates control actions, communicates with its operators, and generates reports, displays, and warnings.
BACnet/IP device	BACnet-certified device used for building automation.
BACnet/IP system	Includes 1...n BACnet devices.
BACnet/IP touch panel	Touch device with an integrated Web Server that processes data from BACnet building automation and control devices and presents it to Web clients via HTML5.0 Web pages. For example, Siemens devices PXM30.E, PXM40.E, PXM50.E.
BACnet/IP Web interface	Provides Web-based, graphical operation of BACnet automation stations using touch panels and devices with an HTML5.0 Web browser. For example, Siemens devices PXG3.W100-1, PXG3.W200-1.
Desigo automation station	PX compact and PX modular controller. For example, PXC100...
Desigo Control Point	A full-featured Web-based solution that provides operating and monitoring functions for building automation and control systems.
Desigo Control Point device	A device that is primarily used for operating and monitoring systems. Standard BACnet devices, such as computers, tablets and smart phones with HTML5.0 Web browsers, are fully supported. For example, Siemens devices PXM30.E, PXM40.E, PXM50.E, PXM30-1, PXM40-1, PXM50-1, PXG3.W100-1, PXG3.W200-1.
Desigo primary server	Provides common network functionality to the Desigo automation stations, such as Time Master.
Desigo PXM wall mounting kit	PXA.V40, PXA.V50.
Desigo room automation station	Desigo devices to control HVAC, lighting and shading applications. For example, DXR2... or PXC3...
Desigo Touch Panel Client	Touch device for communication using an HTML5.0 web server. For example, Siemens devices PXM30-1, PXM40-1, PXM50-1.
end-user room graphics	Graphics with end user rooms widgets, targeted for end user and not primarily for technical oriented users
end-user room widgets	Can be added to graphics, enable the user to directly command light, blinds and HVAC equipment, without opening of an additional window
HTML5.0 Web Server	Enables access from a standard Web browser to a specific system and provides its content in Web pages.

Term	Definition
PXM <sub>xx</sub> .E	BACnet/IP touch panels PXM30.E, PXM40.E, PXM50.E
PXM <sub>xx</sub> -1	Touch panel clients PXM30-1, PXM40-1, PXM50-1
PXG3.W <sub>xxx</sub> -1	BACnet/IP Web interface PXG3.W100-1, PXG3.W200-1
Touch panel client	A Web client for communicating with HTML5.0 capable Web Servers. For example, Siemens devices PXM30-1, PXM40-1, PXM50-1.

## 1.4 Documentation

### Operation and monitoring devices

ASN	Device	Data sheet
PXM30.E PXM40-E PXM50.E	BACnet/IP touch panel 7" with integrated web server BACnet/IP touch panel 10" with integrated web server BACnet/IP touch panel 15" with integrated web server	A6V11664137
PXM30-1 PXM40-1 PXM50-1	Touch panel client 7" Touch panel client 10" Touch panel client 15"	A6V11664139
PXG3.W100-1 PXG3.W200-1	Web server, basic functionality Web server, advanced functionality	A6V10808336

### Manuals

Topic	Document	Document no.
Commissioning	Desigo Touch Panel client commissioning	A6V11604303
Engineering	Desigo Control Point engineering	A6V11604297
Operating	Desigo Control Point operation	A6V11211557
Online help	ABT Site online help	--

## 2 Cyber security disclaimer

Siemens provides a portfolio of products, solutions, systems and services that includes security functions that support the secure operation of plants, systems, machines and networks. In the field of Building Technologies, this includes building automation and control, fire safety, security management as well as physical security systems.





In order to protect plants, systems, machines and networks against cyber threats, it is necessary to implement – and continuously maintain – a holistic, state-of-the-art security concept. Siemens' portfolio only forms one element of such a concept.

You are responsible for preventing unauthorized access to your plants, systems, machines and networks which should only be connected to an enterprise network or the internet if and to the extent such a connection is necessary and only when appropriate security measures (e.g. firewalls and/or network segmentation) are in place. Additionally, Siemens' guidance on appropriate security measures should be taken into account. For additional information, please contact your Siemens sales representative or visit





<https://www.siemens.com/global/en/home/company/topic-areas/future-of-manufacturing/industrial-security.html>.







Siemens' portfolio undergoes continuous development to make it more secure. Siemens strongly recommends that updates are applied as soon as they are available and that the latest versions are used. Use of versions that are no longer supported, and failure to apply the latest updates may increase your exposure to cyber threats. Siemens strongly recommends to comply with security advisories on the latest security threats, patches and other related measures, published, among others, under <https://www.siemens.com/cert/en/cert-security-advisories.htm>.

## 3 Safety notes

	<p><b>⚠ CAUTION</b></p> <p><b>General safety regulations</b> Please comply with the following general regulations during engineering and execution:</p> <ul style="list-style-type: none"> <li>• Measures/prohibitions to prevent the hazard of electrical and mains power ordinances for the given country.</li> <li>• Other applicable, national regulations.</li> <li>• Building installation regulations for the given country.</li> <li>• Regulations of the utility company.</li> <li>• Diagrams, cable lists, dispositions, specifications, and orders by the customer or authorized engineering office.</li> <li>• Third-party regulations, e.g. by the general contractor or building owner.</li> </ul>
	<p><b>⚠ CAUTION</b></p> <p><b>National safety regulations</b> Failure to comply with national safety regulations may result in personal injury and property damage.</p> <ul style="list-style-type: none"> <li>• Observe national provisions and comply with the appropriate safety regulations.</li> </ul>
	<p><b>⚠ CAUTION</b></p> <p><b>Electrical safety</b> The electrical safety for building automation and control systems by Siemens Building Technologies is primarily based on safely separating low voltage from mains voltage.</p>
	<p><b>⚠ CAUTION</b></p> <p><b>IEC (SELV/PELV) (worldwide)</b> Application as per SELV or PELV pursuant to IEC 60364-4-41 "Low voltage electrical installations" depending on the grounding (<math>\perp</math> AC 24 V) of the low voltage: Ungrounded = Safety Extra-Low Voltage (SELV) Grounded = Protection by PELV (Protected Extra Low Voltage)</p>



	<p><b>⚠ CAUTION</b></p>
	<p><b>NEC (North America)</b>          Use of class 2 transformers limited to 100 VA or class 2 circuits at max. 100 VA by a non-limited transformer of max. 400 VA, combined with overcurrent protection (T 4 A fused) for each AC 24 V device. Multiple fuses for multiple insulated secondary circuits per transformer are possible (see Power requirements [→ 28]).          The same applies to DC 24 V power supplies.</p>
	<p><b>⚠ CAUTION</b></p>
	<p><b>Device safety</b>          Device-related safety is guaranteed, among others, by low voltage power supply AC 24 V, DC 24 V and double insulation between the mains voltage AC 230 V, AC 24 V circuits and the housing or Power over Ethernet (PoE Class 4).          Comply with specific regulations for electrical wiring per the following sections.</p>
	<p><b>⚠ CAUTION</b></p>
	<p><b>Grounding ⊥ (system neutral AC/DC 24 V)</b>          Observe the following points when grounding ⊥ AC 24 V (system neutral):</p> <ul style="list-style-type: none"> <li>• Operating voltage of AC 24 V is permitted in principle for both grounded as well as non-grounded system neutrals. Local regulations and customs apply accordingly. Grounding may be required or not allowed for functional reasons.</li> <li>• Recommendation: AC 24 V systems are generally grounded unless otherwise not recommended by the manufacturer.</li> <li>• In order to avoid ground loops, connect systems with PELV to the ground at one location only (especially for transformers), unless otherwise indicated.</li> <li>• The same applies to DC 24 V power supplies.</li> </ul>
	<p><b>⚠ CAUTION</b></p>
	<p>Functional ground ↕          The connections of the functional earth must be connected on the installation side with the building grounding system (PE).</p>
	<p><b>⚠ CAUTION</b></p>
	<p><b>Operating voltage AC/DC 24 V</b>          It must meet requirements for SELV or PELV. Permissible deviation to nominal voltage:          At the transformer/power unit: AC / DC 24 V -10 ... + 20%          At the end device (web server): AC 24 V ±20%, DC 24 V ± 20%          At the end device (touch panel): AC 24 V ±20%, DC 24 V ± 20%</p>

	<b>⚠ CAUTION</b>
	<p><b>Transformer specification AC 24 V</b>          IEC: Use safety insulating transformers as per IEC 61558 with double insulation designed for 100% duty to supply SELV or PELV circuits.          USA: Class 2 circuits per UL 5085-3          Power taken from the transformer should be at least 50% of nominal load for efficiency reasons (effectiveness).          Transformer nominal power should be at least 25 VA. For smaller transformers, the ratio of open circuit voltage to full load is unfavorable (&gt; + 20 %).</p>
	<b>⚠ CAUTION</b>
	<p><b>DC 24 V power supply specification</b>          Designed for 100% duty to supply SELV or PELV electrical circuits.          USA: Class 2 circuits per UL 5085-3.          Power taken from the transformer is at least 50% of nominal load for efficiency reasons (effectiveness).</p>
	<b>⚠ CAUTION</b>
	<p><b>Operational voltage fuse AC 24 V</b>          Transformers on the secondary side correspond to the actual load of all connected devices as per transformer sizing:          AC 24 V line (system potential) must always be fused.          Where required, also fuse line ⊥ (system neutral).</p>
	<b>⚠ CAUTION</b>
	<p><b>Operational voltage fuse DC 24 V</b>          DC 24 V power are short-circuit proof or have internal fuses.          Comply with all local regulations.</p>
	<b>⚠ CAUTION</b>
	<p><b>Mains fuse</b>          Transformers / DC 24 V power on the primary side: Panel fusing (control fuse)</p>
	<b>⚠ CAUTION</b>
	<p><b>Power over Ethernet (PoE) PoE</b>          Designo touch panels require power for PoE+ Class 4 (max. 600 mA / 25.5 W). It must comply with IEEE 802.3at-2009.          Comply with manufacturer guidelines on power to the PoE switches.</p>

**⚠ CAUTION****Caution with regard to foreign voltages**

Any insertion or drawing of dangerous voltages to the system's low-voltage circuit, e.g. caused by improper wiring, directly places people at risk and may result in the partial or complete destruction of the building automation and control system.

## 4 Overview

### 4.1 Devices

Desigo Control Point is an embedded building management station to operate and monitor building automation and control systems on BACnet/IP.

Room users can also operate room applications (using QMX7 widgets).

Functionality can be adapted to any user profile – from room users to facility managers.

#### Operable systems

- Desigo primary plants
- Desigo room automation
- BACnet third-party devices

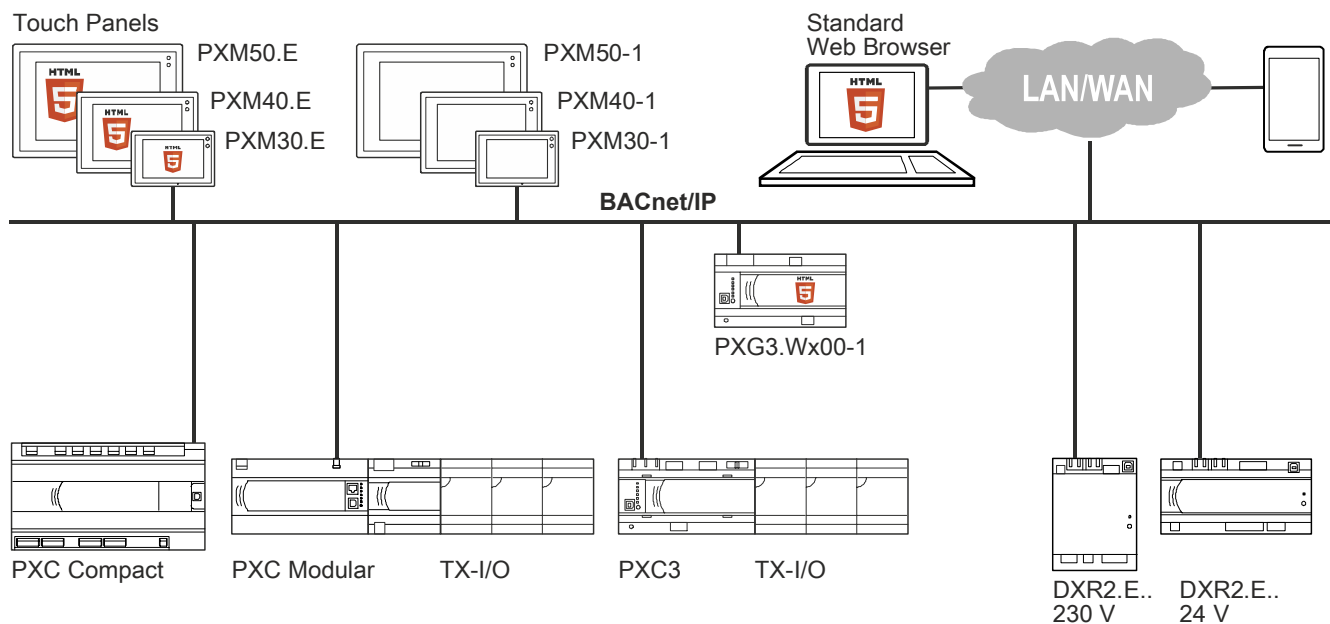

#### Operation and monitoring devices

ASN	Device	Data sheet
PXM30.E PXM40.E PXM50.E	Touch panel client 7" Touch panel client 10" Touch panel client 15"	A6V11664137
PXM30-1 PXM40-1 PXM50-1	BACnet/IP touch panel 7" with integrated web server BACnet/IP touch panel 7" with integrated web server BACnet/IP touch panel 7" with integrated web server	A6V11664139
PXG3.W100-1 PXG3.W200-1	Web server, basic functionality Web server, advanced functionality	A6V10808336

#### Standard operator units

Operation and monitoring is also possible on standard operator units with HTML5.0 web browsers.

## 4.2 Functions

Desigo Control Point offers efficient and intuitive building operation.

Function	Touch panel		BACnet/IP web interface	
	TCP/IP	BACnet/IP	PXG3.W100-1	PXG3.W200-1
	PXM50-1 PXM40-1 PXM30-1	PXM50.E PXM40.E PXM30.E		
Generic operation of all objects/parameters	Available on PXG3.Wx00-1	✓	✓	✓
Operation of Desigo primary and room automation stations as well as third-party BACnet devices		✓	✓	✓
User administration (create, delete, and edit)		✓	✓	✓
User access rights		✓	✓	✓
Alarm view		✓	✓	✓
Alarm and event history		✓	✓	✓
Alarm forwarding to email recipient		✓	✓	✓
Trend Viewer (online and offline trends)		✓	✓	✓
Scheduler operation		✓	✓	✓
Heating curve		✓	✓	✓
Animated graphics (plants, rooms, floors, etc.)		✓	✓	✓
Integrated web server for remote access		✓	✓	✓
Graphics engineering online over the desktop web browser		✓	✓	✓
Manual trend data export		✓	✓	✓
Haystack interface		✓	✓	✓
Energy dashboards		x	x	✓
Kiosk presentation (available on PXMxx.E and PXG3.Wx00)		✓	✓	✓
Automatic trend data export		x	x	✓
System status report		x	x	✓
Documents (Download of PDF documents to the Web server)		x	x	✓

## 4.3 Commissioning

No tool is required to commission the devices. Commissioning is performed directly on the touch panel or using an HTML5 browser. The devices are operated using standard operating views. Graphics can be created or edited online using the integrated graphics editor.

The workflows for commissioning and service are the same as for other Desigo devices.

For further information, see:

- Desigo Touch Panel clients commissioning A6V11604303.

## 4.4 Engineering

No engineering is required to prepare standard operating views.

The offline engineering workflow is fully integrated in ABT Site:

- Building hierarchy
- Device topology
- Create graphics

Graphics engineering in the runtime system via HTML 5.0 web browser.

Graphic library with a large number of templates and symbols.

User interfaces for technical operators and end users are created using the same engineering solution.

For further information, see:

- Desigo Control Point user's guide A6V11211557
- Desigo Control Point engineering (A6V11211560)

## 5 Functions in detail

### 5.1 User profile

- Users can be managed offline with ABT Site or online using a web browser.
- Each administrator can create additional users on its own user level or lower.
- Customized users must be created using ABT Site.
- ABT Site administers password security.

Views / rights	User profile						
	Administrator	Advance engineer	Standard engineer	Advanced user	Technical operator	Standard user	Customized user
Plant view	✓	✓	✓	✓	✓	✓	Can be configured
Alarm view	✓	✓	✓	✓	✓	✓	Can be configured
Scheduler	✓	✓	✓	✓	✓	✓	Can be configured
List view	✓	✓	✓	✓	✓	✓	Can be configured
Trend view	✓	✓	✓	✓	✓	✓	Can be configured
Report view	✓	✓	✓	✓	✓	✓	Can be configured
Documents view *)	✗	✗	✗	✗	✗	✗	Can be configured
Alarm acknowledgement	✓	✓	✓	✓	✓	✓	Can be configured
Tools (available if application view is selected) Tools – Settings (SMTP, FTP, etc.)	✓	✓	✓	✗	✗	✗	Can be configured
Integrate data points	✓	✓	✗	✗	✗	✗	✗
Create / edit / delete users	✓	✗	✗	✗	✗	✗	✗
Switch off automatic logout	✗	✗	✗	✗	✗	✗	Can be configured
Setup & Service Full access, all applications	✓	✓	✓	✓	✗	✗	Can be configured
Setup & Service Generic data point list	✓	✓	✓	✓	✓	✗	Can be configured

\*) The Documents core function is not enabled per default.

## 5.2 Access levels

Desigo assigns each data point / BACnet object one of the following object access levels:

#	English	Description
0	No access	Special objects that are not displayed on the runtime system
1	Internal	Special objects/pins for very special tasks
2	Extended service	Not used in the HQ solution
3	Basic service	Objects/pins that are important for commissioning
4	Administrator	Not used in the HQ solution
5	Extended operation	Objects/pins for operating & monitoring by trained personnel
6	Standard operation	Objects/pins for day-to-day operating & monitoring on the management station
7	Basic operation	The most important information for room users Primary plants: Rarely used

The access level is application specific. It is set to allow each user to display the appropriate data points. The access level of a data point can be viewed and edited in CFC.

### Primary plant

Each pin for a data point has its own access level. The data points receive the access level for pin PrVal during learning in Desigo Control Point.

### Room automation

Each data point has only one access level.

### Third-party devices and systems

Third-party devices and systems do not know the access levels for the data points. The function "Data point integration" integrates all data points.

### User role

Each user role has a defined access level applicable to the user. The user can filter the displayed data points within the assigned access level to improve the overview.

### Graphics-based operation

The access levels are also used to limit the number of integrated data points.

We recommend the following access levels for integration if each integrated data point is fully graphically operated:

- Extended operation for Desigo primary automation stations
- Standard operation for Desigo room automation stations
- No access levels are available for BACnet third-party automation stations. As a consequence, all data points are always selected by default.

The data points can be integrated at the lowest access level if no graphical operation is required.

The selection of integrated data points can be optimized and individually customized in the data point integration function using Advanced Tools. The tool can individually select or exclude data points.

The alarm view is NOT based on the integrated data points. For assigned devices, all objects in an alarm state are always displayed regardless of whether or not the corresponding object was integrated.



## Generic operation

Desigo Control Point offers generic data point operation. The user can operate all objects and properties of the assigned device list. This is also true for the alarming. All objects in alarm will be monitored of the assigned device list. The structure and content is based on the BACnet device and workflow.

The following generic data point lists are available via navigation "Setup and Service":

Setup & Service operating view	Tool-free commissioning	Commissioning with ABT site
Assigned devices	✓	✓
Application > List view > Geographical	✗	✓
Application > List view > Sites	✓	✓

## 6 System limits

### 6.1 Device-related limits

Function	Touch panel BACnet/IP		BACnet/IP web interface	
	PXM30.E	PXM40.E PXM50.E	PXG3.W100-1	PXG3.W200-1
Generic operation	All data points of all assigned devices			
Graphical operation (BACnet objects)	500	1,000	1,000	2,000
Haystack interface (BACnet objects)	500	1,000	1,000	2,000
Online trends	20	20	20	50
Graphics (average complexity)	20	20	20	50

### 6.2 Memory management

	PXM30.E	PXM40.E PXM50.E	PXG3.W100-1	PXG3.W200-1
<b>Available application memory</b>	3 GB	3 GB	3 GB	3 GB
<b>Memory requirements</b>				
Max. number of DPs that can be integrated for graphical operation	1,500 kB (500 DP)	2,500 kB (1,000 DP)	2,500 kB (1,000 DP)	5,000 kB (2,000 DP)
Max. number of plant graphics at 300 kB each	6,000 kB (20 graphics)	6,000 kB (20 graphics)	6,000 kB (20 graphics)	15,00 kB (50 graphics)
Alarm history - 10,000 entries	5,000 kB	5,000 kB	5,000 kB	5,000 kB
1 online trend (multistage object) 1 year, 24 entries per day = approx.. 9,000 values	800 kB	800 kB	800 kB	800 kB
1 report with 1,000 objects	200 kB	200 kB	200 kB	200 kB
Documents function – max total size	--	--	--	50 MB
Documents function – max single document size	--	--	--	10 MB
Documents function – max documents	--	--	--	50

## 6.3 Graphics-based operation

Data point capacity is limited for graphical operation (data point integration).

The figures below apply to integration over the standard user level and where full graphical operation of all data points is required.

	Desigo primary plant	Desigo room automation	
Access level for integration	Extended operation	Standard operation	
Max. number *	Number of hardware-I/Os **	Number of simple rooms (HVAC only)	Number of complex rooms (HVAC, lighting, shading)
PXG3.W100-1	400	30	10
PXG3.W200-1	800	60	20
PXM30.E	200	15	5
PXM40.E	400	30	10
PXM50.E	400	30	10
PXM30-1, PXM40-1, PXM50-1	n.a. (see limits for PXG3.Wx00-1)		

\* The selection of integrated data points can be optimized and individually customized with the Advanced Tool in the data point integration function.

\*\* Primary plants: Per hardware I/O some 2.5 BACnet objects are integrated on average.

## 6.4 Technical limits

The following limits are recommended and verified.

Function	Touch panel		BACnet/IP web interface
	TCP/IP	BACnet/IP	
	PXM50-1 PXM40-1 PXM30-1	PXM50.E PXM40.E PXM30.E	PXG3.W100-1 PXG3.W200-1
Max. number of assigned devices BACnet/IP BACnet MS/TP *) BACnet LonWorks *)	n.a.	50 10 10	50 10 10
Number of simultaneously connected operator clients <sup>1</sup>	n.a.	5	5
Max number of devices connected to one BACnet device	n.a.	5	5
Data points per plant graphic	n.a.	40	40
Data points (in a table)	n.a.	40	40
Number of defined users	n.a.	8	8
Trend chart, max. number of entries (Max. 5 trends, with 10,000 each)	50,000	50,000	50,000
Max. entries per online trend <sup>2</sup>	10,000	10,000	10,000
Max. entries per BACnet trendlog object <sup>3</sup>	5000	5000	5000
Trend export: Max. number of entries per trend	10,000	10,000	10,000
Max. alarm History entries	10,000	10,000	10,000

\*) see specific MSTP and LonWorks section for more specific limitations

- <sup>1</sup> 5 is the recommended number. More clients can be connected, but performance deteriorates when the same operations are performed simultaneously. Example: Simultaneous load of the same plant graphic to 10 clients.
- <sup>2</sup> Trend data management must be configured according as part of the online trend configuration.  
10,000 trend entries can be recorded from:
- 1 trend entry daily over a minimum of 25 years
  - 1 trend entry every hour over a minimum of 1 year
  - 1 trend entry every 15 minutes over a minimum of 3 months
- <sup>3</sup> The time to read a BACnet trendlog object depends on the number of entries and the data link.

Desigo Control Point is optimized for BACnet/IP devices which are supporting COV communication. The objects of an assigned device will automatically be polled if the device does not support COV. Polling causes a higher network communication load. This can decrease the overall performance of the Desigo Control Point device, depending on the BACnet device and on the type of communication (MS/TP, LonWorks). Such topologies must be tested individually and project specifically.

## 6.5 LonWorks limits

Use the router PXG3.L / PXG3.M with **HW Index C only**.

Data point integration: LonWorks devices take a lot longer than IP devices due to the lower network speed.  
Reference value: Approximately 30 times longer (depending on the project setup).

To avoid timeout problems,

- Use the workflow: Data point integration.
- Integrate at the standard user level
- Avoid the "Cache" dialog
- Create templates for individual data point selection for LonWorks devices on IP devices. These templates can then be imported to the LonWorks devices.

## 6.6 Limits for MS/TP

Use the router PXG3.L / PXG3.M with **HW Index C only**.

Data point integration: MS/TP devices are considerably slower than IP devices due to the lower network speed.  
Reference value: Approximately 15 times slower (depending on the project setup).

MS/TP is tested with 10 devices that support COV (e.g. DXR2). Recommendation: Assign or integrate a maximum of 10 MS/TP devices on one network branch. More devices and/or network complexity are permitted, but they may result in longer and inconsistent times and degraded performance.

- Assign devices offline/online:  
More than 10 devices degrade performance in ABT-SSA.  
Additional network branches degrade performance in ABT-SSA.
- Device learning offline/online:  
More than 10 devices takes longer.  
The times are slower with additional network branches.
- Device restart (e.g., after the power returns):  
More than 10 devices takes longer.  
The times are slower for a restart.

The following limits and constraints must be considered if the MS/TP devices do not support COV, i.e. only polling:

- Disable the list view core function (user profile setting in ABT Site)
- Limit to one concurrent operating client (limit your network topology)
- Set baud rate to 38400 or higher
- Only use the online trends functionality very limited
- Limit the points per graphic to 15

## 6.7 Supported BACnet objects

The BACnet objects supported in Desigo Control Point are listed in the Appendix [→ 40].

## 7 Compatibility

### 7.1 Compatibility with earlier systems

System compatibility	PXM50-1 PXM40-1 PXM30-1	PXM50.E PXM40.E PXM30.E	PXG3.W100-1	PXG3.W200-1
Desigo PX primary plants	n.a.	as of Desigo V4.0		
Desigo room automation PXC3	n.a.	as of Desigo V5.0		
Desigo room automation DXR2	n.a.	as of Desigo V6.0		
BACnet third-party devices	n.a.	as of BACnet revision 1.05 (± Desigo V4.0)		

### 7.2 Compatibility with earlier devices

Desigo devices ≤ Desigo V6.0	Desigo Control Point			
	PXM50-1 PXM40-1 PXM30-1	PXM50.E PXM40.E PXM30.E	PXG3.W100-1	PXG3.W200-1
PXG3.W100			n.a.	n.a.
PXM20-E		PXM30.E		
PXM40	PXM40-1			
PXM50	PXM50-1			

#### PXM20-E

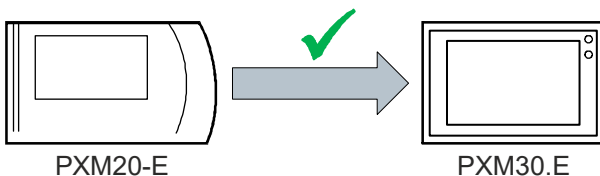

- The dimensions for the cut out are the same as for mounting in the panel.
- Supply voltage AC/DC 24 V.
- Ethernet connection for communication.
- No Power over Ethernet (PoE) connection on PXM30.E.

#### PX web

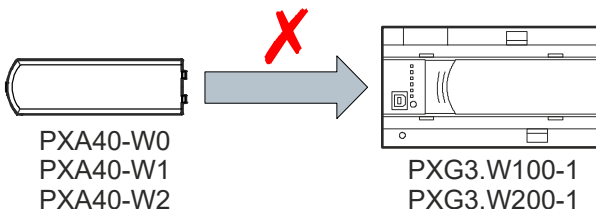

- PX web graphics are not compatible with graphics for the new web interface PXG3.Wx00-1.
- No workflow is currently available to automate migration of PX web graphics.
- New graphics can be efficiently created, based on templates or existing graphics.

## Designo Touch and Web

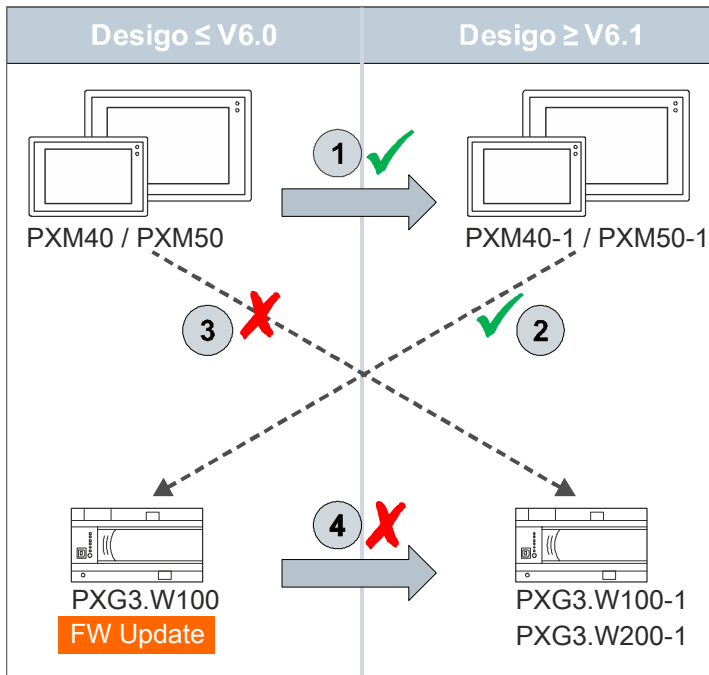

- ① Same dimensions for the cut out as for mounting in the panel  
Supply voltage AC/DC 24 V  
Ethernet connection  
Similar look and feel
- ② PXM40-1 and PXM50-1 panels are backward compatible with PXG3.W100 (PXG3.W100 FW updated required).  
For engineering, see ABT SSA User's guide (A6V10429119), Section 4.4.1 - "Configuration of operating and monitoring devices"
- ③ Existing PXM40 and PXM50 panels are not compatible with the new web interface PXG3.Wx00-1
- ④ Engineering data, including graphics are not compatible with the new web interface

## 8 Supported browsers

The following browsers support graphics and operation:

Graphics editor	Google Chrome* Graphics can be created and edited without a tool using this browser.
Grade A Recommended web browser for standard operator units.	Google Chrome on desktop* Google Chrome on Android tablet* Google Chrome on Surface tablet* Microsoft Edge on Surface tablet <ul style="list-style-type: none"> <li>Fully tested and supported browser.</li> <li>All functions are available and can be executed as documented.</li> </ul>
Grade B Compatible web browser.	Google Chrome on Android cellphone* Microsoft Edge on desktop <ul style="list-style-type: none"> <li>Fully tested and supported browser.</li> <li>Basic functions are available and can be executed as documented.</li> <li>Minor deviations in terms of display and operation to recommended browsers are possible (fonts, etc.).</li> </ul>
Grade C Partially compatible standard web browsers.	Firefox Internet Explorer 11 All web browsers on iOS devices <ul style="list-style-type: none"> <li>Minimally tested browsers.</li> <li>Not supported with Desigo Control Point.</li> <li>Access to the web server is possible in principle.</li> </ul>

\* Chrome remains automatically on https when visiting an HTTPS page. It must be manually switched back to http to work with Desigo Control Point.



## 9 Planning (hardware)

### 9.1 IT security

Desigo Control Point works with devices with a web interface. Technically, this would allow to remote connect to their web interface also by the Internet. **For security reasons, this is not allowed directly.**

If a remote access is required, it mandatorily must be secured by dedicated additional network IT-security means. As a consequence, you must comply with all IT security rules.

All participants must have a solid understanding of possible risks and side effects associated with new and efficient functions (especially remote access).

Refer in this regard to the document *"IT security on installation with Desigo"*(CM110663).

Secure certificates for web server (PXMxx-E, PXG3.x00-1) can be created in ABT Site (see online help).

### 9.2 Ports for remote access

The following ports must be open on the firewall for Desigo Control Point:

#### Incoming connections

TCP / 80	http (general access)
TCP / 443	https (secured access)
UDP / 30000	S1 Discovery
UDP / 30001	S1 Discovery
UDP / 47808	BACnet (changes depending on configuration)
UDP / 47874	BACnet (changes depending on configuration)
UDP / 68	DHCP

#### Outgoing connections

TCP / 443	Desigo Control Point communicates on a regular basis with skyfoundry.com, current at 208.74.84.249, to check licensing and security. Note: A connection to skyfoundry.com is not required for Desigo Control Point to operate.
-----------	---

## 9.3 Topologies

Various viewpoints can guide planning operating and monitoring concepts:

- Who operates which parts of the plant?
- What devices are used?
- How large is the system?
- How is the building subdivided (floors, tenants, etc.)?

### Use case: Small project

Project requirements:

- Small heating and ventilation plants
- Web access for remote operation
- Local operator unit

Example:

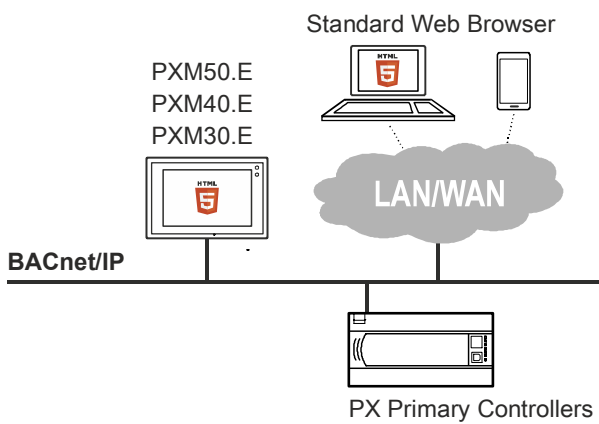

### Use case: Mid-sized project

Project requirements:

- Multiple heating plants and/or air handling units
- Some rooms have room automation
- BACnet third-party devices
- Multiple, local operator units
- Web access for remote operation

Example:

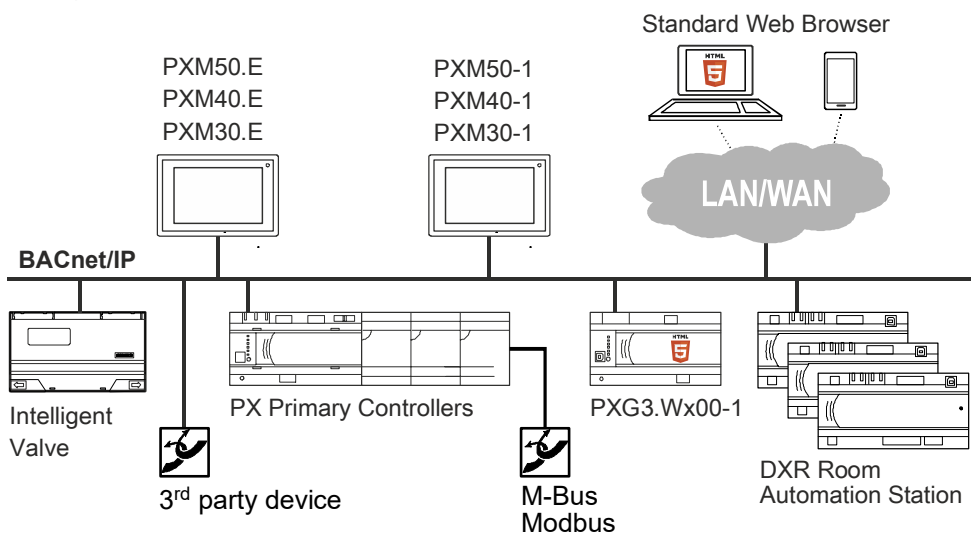

### Use case: Project without touch panels

Project requirements:

- Multiple heating plants and/or air handling units
- Some rooms have room automation
- Web access for remote operation

Example:

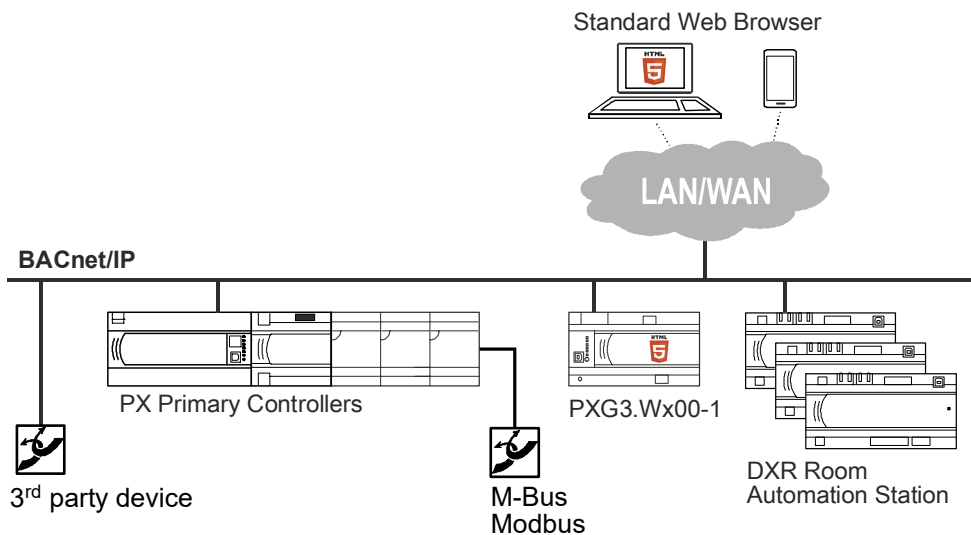

### Use case: Large and complex project

Project requirements:

- Office building
- Lots of offices and technical rooms
- Central operation for the entire building
- Decentralized operation of rooms and plants

Desigo CC for central operation

Touch panels with or without web server for decentralized operation

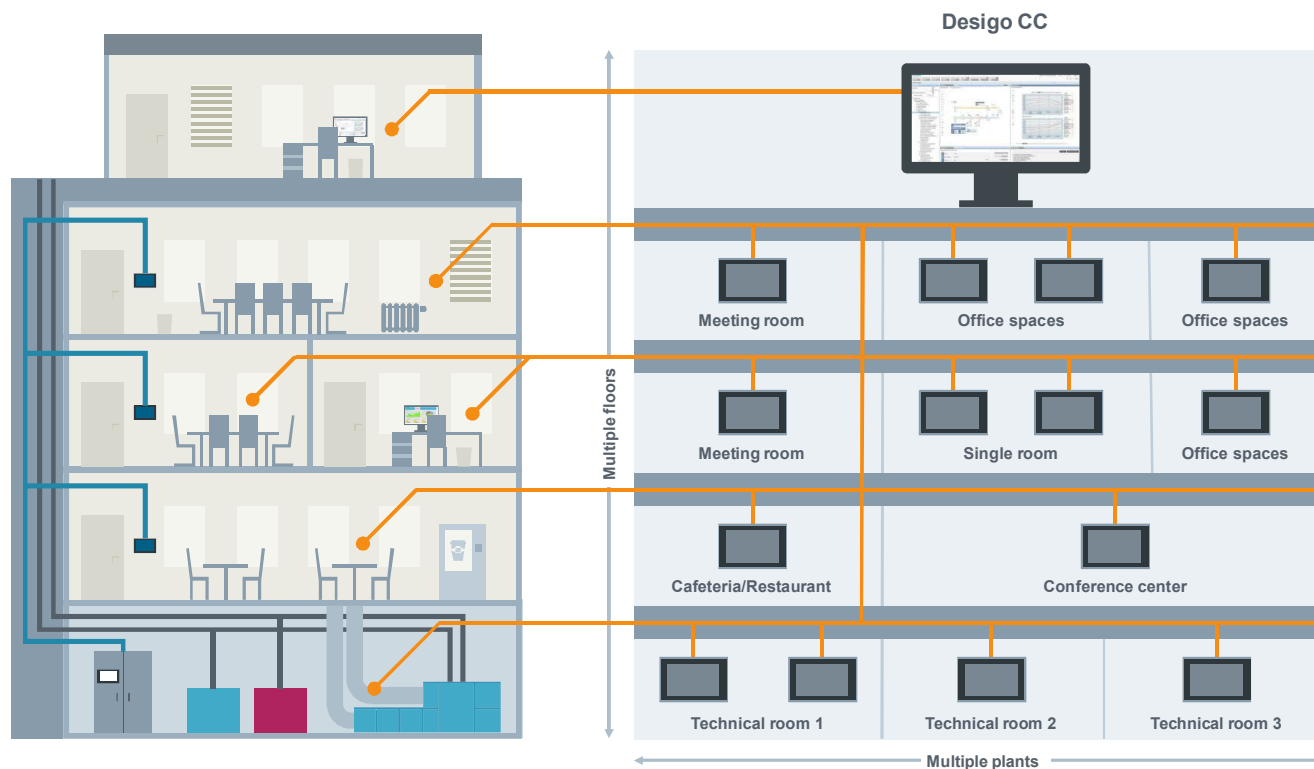
**Example:**

## 9.4 Power requirements

### 9.4.1 Power consumption per device

Type	AC 24 V $\pm$ 20 %	DC 24 V $\pm$ 15%	PoE (DC 48 V Class 4)
PXM30-1 PXM30.E	Max. 29 VA	Max. 17 W	n.a.
PXM40-1 PXM40.E	Max. 32 VA	Max. 21 W	Max. 22 W *)
PXM50-1 PXM50.E	Max. 42 VA	Max. 26 W	Max. 25 W *)

\*) Applies to normal operation. Can be higher at start-up (IEEE 802.3at Class 4).  
 Power over Ethernet. See Section Power over Ethernet.

Type	AC 24 V $\pm$ 20 %	DC 24 V $\pm$ 20%
PXG3.W100-1 PXG3.W200-1	Max. 9 VA	Max. 4 W

## 9.4.2 Transformer sizing AC 24 V

The transformer power is the sum of the power consumption of the connected devices.

### Operating voltage

The operating voltage is AC 24 V. It must meet the requirements for SELV or PELV per IEC 60364-4-41.

NEC: Class 2 transformers or class 2 circuits.

Permissible deviation to nominal voltage AC 24 V on the Transformer: +20%/-10%.

This guarantees a tolerance of +/- 20% on the devices after considering line and contact resistance.

### Transformer specification AC 24 V

IEC: Use safety insulating transformers as per EN 61558 with double insulation designed for 100% duty to supply SELV or PELV circuits.

NEC: Class 2 transformers.

Transformer nominal power should be at least 25 VA. For smaller transformers, the ratio of open circuit voltage to full load is unfavorable (> + 20 %).

The nominal transformer power should not exceed 200% of maximum load for efficiency reasons (effectiveness).

### Wire lengths: Power supply AC 24 V

The basis for calculation is a permissible voltage drop off of 2.4 V (10%) on the power line from the transformer to the farthest power point.

The following table outlines the wire lengths and diameters based on load.

Cross-section/power	Cable length for AC 24 V				
	10 VA	20 VA	50 VA	100 VA	200 VA
2.50 mm <sup>2</sup> / AWG14	350 m	175 m	75 m	35 m	18 m
1.50 mm <sup>2</sup> / AWG16	210 m	105 m	42 m	20 m	10 m
1.00 mm <sup>2</sup> / AWG18	135 m	68 m	27 m	14 m	7 m

The supply wire (AC 24 V) and return wire (⊥) can each have the indicated lengths.

Each power point is either connected separately to the terminal bar on the transformer (star wiring) or looped.

Power is added together for multiple back-to-back looped devices which reduces the cable length accordingly.

Cables may be wired in parallel to increase the cross section.

In practice, the small level of permissible voltage drop off means that the transformer must always be installed in close proximity to the devices and that any cascading powering of devices is only possible over short distances or at small outputs.

### 9.4.3 Power requirements for DC 24 V

#### Operating voltage

The operating voltage is DC 24 V. It must meet the requirements for SELV or PELV per IEC 60364-4-41.

NEC: Class 2 circuits.

Permissible deviation to nominal voltage DC 24 V on the power supply: +15% / -10%.

This guarantees a tolerance of +15/-15% on the devices after considering line and contact resistance (web server: -20%).

#### Wire lengths: Power supply DC 24 V

The basis for calculation is the permissible voltage drop off of 2.4 V (10%, web server) or 1.2 V (5%, touch panels on the power line between the power supply and the farthest power point).

The following tables outline the wire lengths and diameters based on load.

Cross-section/power	Cable length DC 24 V – Web server				
	10 VA	20 VA	50 VA	100 VA	200 VA
2.50 mm <sup>2</sup> / AWG14	350 m	175 m	75 m	35 m	18 m
1.50 mm <sup>2</sup> / AWG16	210 m	105 m	42 m	20 m	10 m
1.00 mm <sup>2</sup> / AWG18	135 m	68 m	27 m	14 m	7 m

Cross-section/power	Cable length DC 24 V – Touch panels				
		20 VA	50 VA	100 VA	200 VA
2.50 mm <sup>2</sup> / AWG14		75 m	35 m	18 m	9 m
1.50 mm <sup>2</sup> / AWG16		42 m	20 m	10 m	5 m
1.00 mm <sup>2</sup> / AWG18		27 m	14 m	7 m	3.5 m

The supply wire (AC 24 V) and return wire (⊥) can each have the indicated lengths.

Each power point is either connected separately to the terminal bar on the power supply (star wiring) or looped.

Power is added together for multiple back-to-back looped devices which reduces the cable length accordingly.

Cables may be wired in parallel to increase the cross section.

In practice, the small level of permissible voltage drop off means that the power supply must always be installed in close proximity to the devices and that any cascading powering of devices is only possible over short distances or at small outputs.

## 9.5 Ethernet

For detailed information on Ethernet, see:

- *Ethernet, TCP/IP, MS/TP and BACnet fundamentals* (CM110666)
- *Practical guide on IP networks in building automation and control* (CM110668)
- *Practical guide on BACnet networks in building automation and control* (A6V11159798)
- *Desigo building automation and control - Technical principles* (CM110664)
- *IT security on installations with Desigo* (CM110663)

The following provides only specific notes on topology.

### Topologies

You can use the following bus topologies:

- Star topology
- Line topology (for web server)

#### Star topology

Touch panels can only be connected in a star topology.

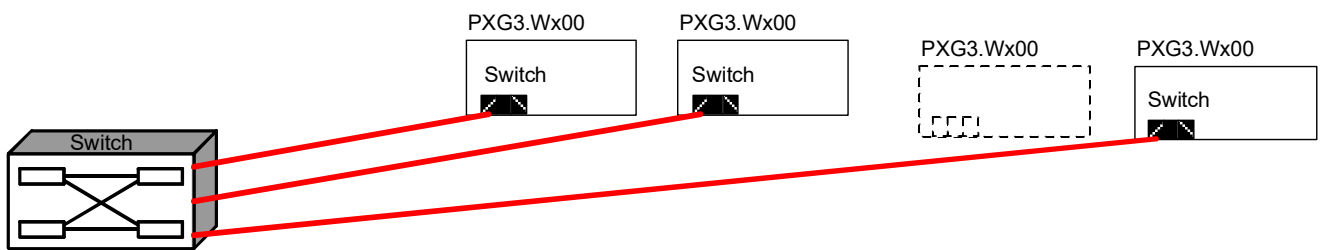

#### Line topology

The number of devices is limited to 20 for a line topology (daisy chain).

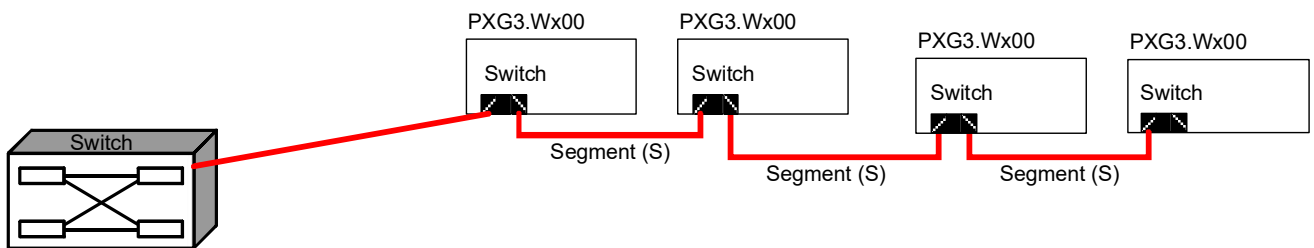

#### Availability/reliability

The Ethernet switch does not work on a device without 24 V power. The following devices, connected in a line topology, are no longer on the network. As a result, each web server should be separately powered with 24 V for secure system operation.

## 9.5.1 Cable

Design Control Point devices are connected over switches and Ethernet cable with RJ45 plugs.

The following conditions must be met:

Bus cable and length:

- Standard Ethernet cable: Min. category 5
- Shielded or unshielded
- STP (Shielded Twisted Pair) or UTP (Unshielded Twisted Pair)
- Length between switch and room automation station: max. 100 m
- Length between room automation stations: Max. 100 m
- Number of devices on a line topology: Max. 20
- For PoE Class 4, the maximum cable resistance is 12  $\Omega$ .

Switch: Standard product from IT at 100 Mbps

## 9.5.2 Power over Ethernet (PoE) PoE

Principle: "Usable signal and power supply on the same cable".

### Benefits

Power over Ethernet (PoE) is a simpler solution to supply power to low consumption room operator units. It saves on power cables and associated installation costs. PoE can be used to connect Ethernet devices in difficult to access locations or areas where multiple cables are disruptive.

For further information on Power over Ethernet (PoE), see *Ethernet, TCP/IP, MS/TP and BACnet fundamentals* (CM110666).

\*

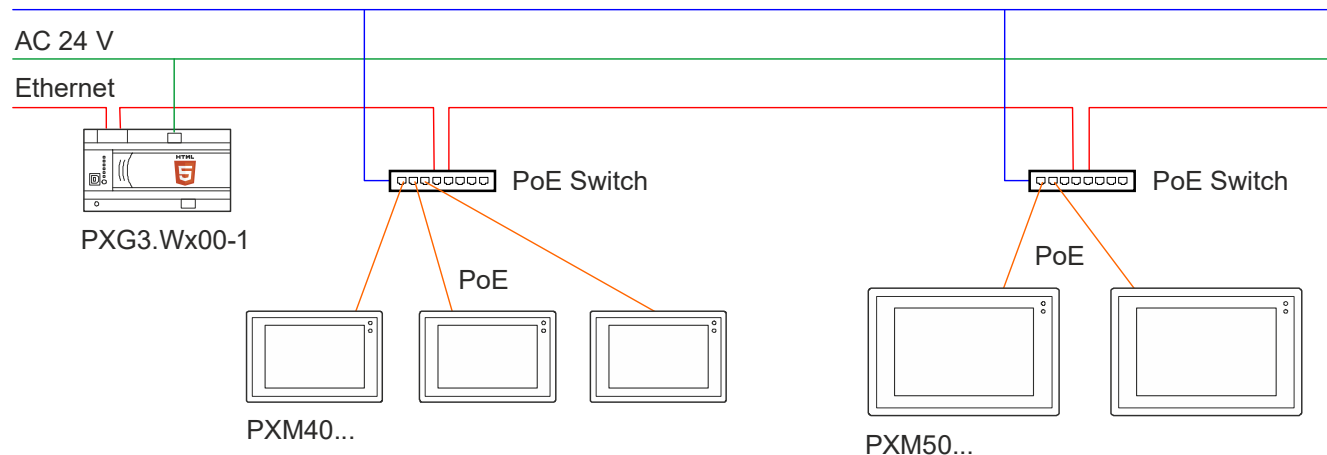

\* Power voltage and current is based on the PoE switch used as well as the number of connected touch panels.

### Function

On PoE, Powered Devices (PDs, here: End units) are supplied by Power Sourcing Equipment (PSEs). The voltage is supplied over the RJ45 plug and twisted pair cable (TP), and by device over:

- Wires that also transmit data
- Unused wires on the RJ45 connection



## PoE topologies

PoE requires a star topology. Typical PoE switches have 4 to 16 outputs.

As a result, multiple switches are used in a line topology on larger systems (e.g. suites in a hotel).

Additional topologies:

- Certain switches (general industrial types) possess an uplink, i.e. multiple switches can be switched in series.
- An individual consumer can be powered using a PoE injector. This is an intermediate power source (mid span), in contrast to direct power by the PoE switch (end span).

## PoE switches / injectors

- Use only switched design for industrial use
- Transmission speed: 100 Mbps
- Compliant with IEEE 802.3at
- Power class 4 (12,95-25,50 W)
- Type 2
- The switches must support supply alternative A

## Selection criteria

- Required number of outputs
- Required power
- Operating switch voltage
- (PoE itself operated at DC 48 V; various switches can, however, be powered for example at DC 18...24 V or AC 230 V)
- Installation location (due to protection class)

## 10 Mounting

### 10.1 Touch panels PXM...

#### Panel mounting

A cut out with the following dimensions is required to mount the touch panel on the panel door.

Wall thickness: 1 mm to 4 mm

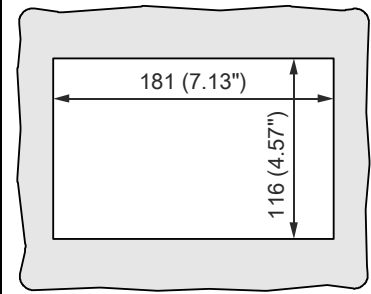
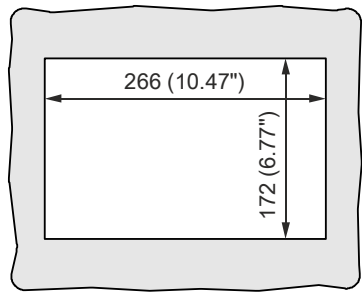
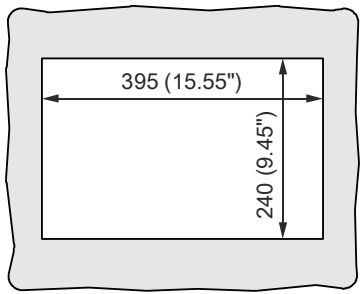
Cut out for PXM30...	Cut out for PXM40...	Cut out for PXM50...
		

#### Example PXM40:

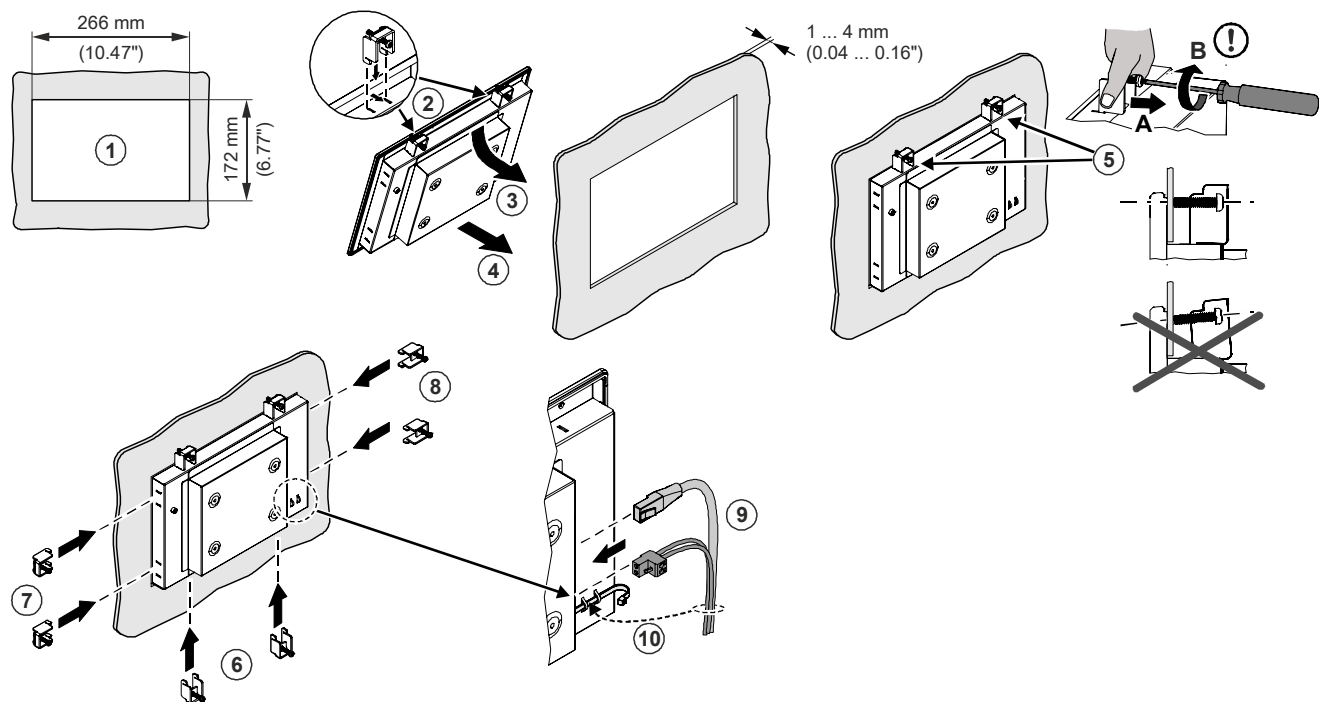

## Recessed mounting

Installation frames PXA.V40 and PXA.V50 are used to install a touch panel in a recessed wall.

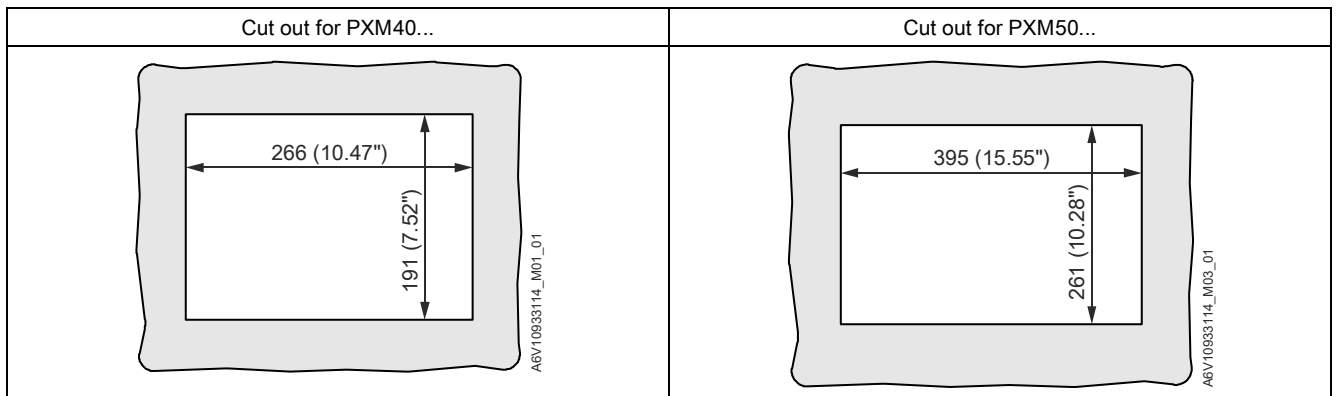

### Example PXM40:

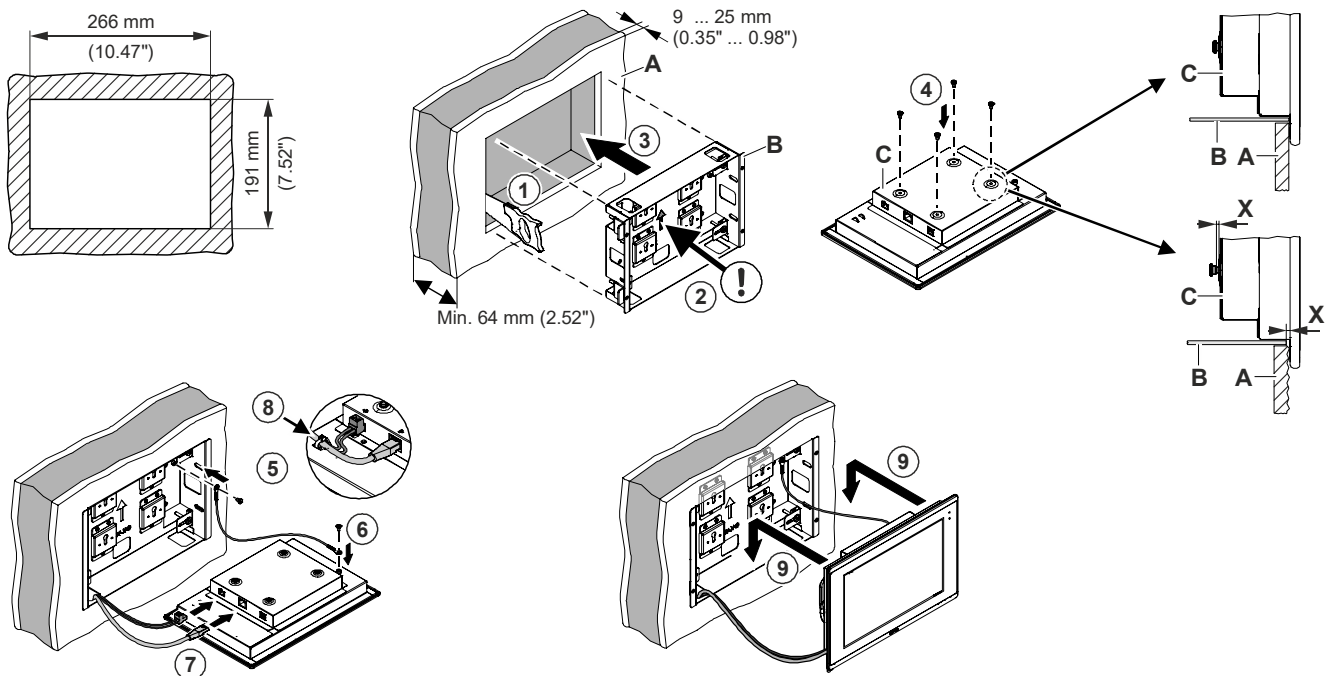

④ You can loosen the fixing crews a bit if the plaster is uneven. This increases the panel's distance to the wall.

A Wall plate

B Mounting frame

C Touch panel with fixing screw

X Panel distance to the wall

## 10.2 Web server

### Mounting on standard rails

The devices are snapped on directly to standard rails.

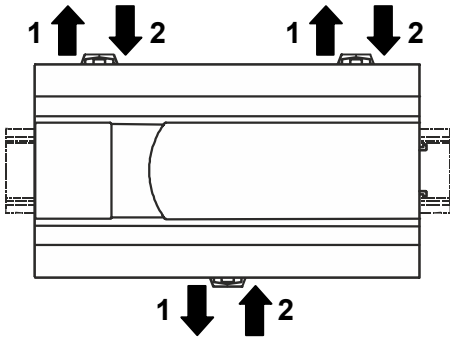

# 11 Wiring

## Cabling and duct cross section

Wire the devices in the standard manner in the cable ducts.

Recommendation: Design the duct cross-section with at least 30% in reserve.

## Wiring and connection terminals

Use wiring types and diameters as per the specifications below:

Item	Specification
Cabling	Use standard stranded cable and wiring. The ends can be connected directly or strengthened with conductor sleeves or pin connectors.  Important: If low-voltage wiring runs alongside mains voltage, it must have the same level of insulation as wiring for mains voltage.
Device connection terminals	The device connection terminals are designed for wiring for: Min. 0.5 mm Ø Max. 2 x 1.5 mm <sup>2</sup> or 1 x 2.5 mm <sup>2</sup>  Connection terminals are so-called lifting clams. The contact plate between the wire and the screw end is easy on the wiring.  Important: Only the original plug-in connection terminals may be used as the connection facility

## Tightening torque

Set the torque to 0.5-0.6 Nm or 50-60 SCM (0.37...0.44 lb ft) when using electrical screwdriver on the connection terminals.

## 11.1 Power supply AC 230 V

### Basic implementation for web server

The diagram below illustrates basic wiring for power lines for web server using AC 24 V operating voltage per PELV:

They are wired in a star as view from the connection terminals (24 V ~ , ⊥).

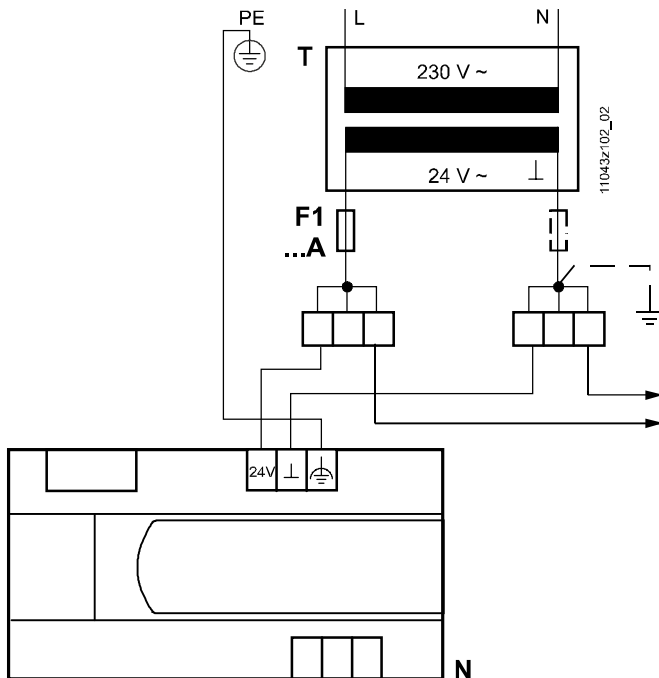

N Web server

T Safety transformer AC 230 V / AC 24 V as per EN 61 558.

F1 Low-voltage fuse, for max. power with AC 24 V.

24 V System potential AC/DC 24 V

⊥ System zero

⚡ The connections of the functional earth must be connected on the installation side to the building grounding system (PE).

24 V distributor to PXG... keep wiring as short as possible. 24 V distributor is the start point.

### Lines

#### Line materials

Use the following material for 24 V wiring and ⊥ for the supply voltage AC 24 V:

- Stranded wire with a cross-section of 1 mm<sup>2</sup>, 1.5 mm<sup>2</sup>, or 2.5 mm<sup>2</sup>
- Individual or a 2-wire cable.

For information on wire lengths and cross sections, see Section Power requirements [→ 28].

#### Transformer phase position

The transformer phase position to one another is not relevant, in other words, the transformers can be powered using the different phases ( L1, L2, L3 ).

## 11.2 Power supply DC 24 V

The same rules apply as for AC 24 V.

## 12 Disposal

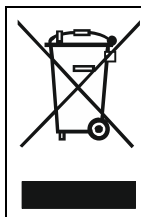

The device is considered an electronic device for disposal in accordance with the European Guidelines and may not be disposed of as domestic garbage.

- Dispose of the device through channels provided for this purpose.
- Comply with all local and currently applicable laws and regulations.

## 13 Appendix - Supported BACnet objects

Id	Name	Graphics / List view Integrated points			Generic operation SSA		
		System			System		
		Desigo XWP	Desigo ABT	BACnet standard	Desigo XWP	Desigo ABT	BACnet standard
0	analog-input	x	x	x	x	x	x
1	analog-output	x	x	x	x	x	x
2	analog-value	x	x	x	x	x	x
3	binary-input	x	x	x	x	x	x
4	binary-output	x	x	x	x	x	x
5	binary-value	x	x	x	x	x	x
6	calendar	x	x	x	x	x	x
7	command	x	x	x	x	x	x
8	device	n/a	n/a	n/a	x	x	x
9	event-enrollment	n/a	n/a	n/a	x	x	x
10	file	n/a	n/a	n/a	n/a	n/a	n/a
12	loop	x	x	x	x	x	x
13	multi-state-input	x	x	x	x	x	x
14	multi-state-output	x	x	x	x	x	x
15	notification-class	n/a	n/a	n/a	x	x	x
16	program	n/a	n/a	n/a	x	x	x
17	schedule	x	x	x	x	x	x
19	multi-state-value	x	x	x	x	x	x
20	trend-log	n/a 2)	n/a 2)	n/a 2)	x	x	x
23	accumulator (32-bit)	x	n/a	x	x	n/a	x
23	accumulator (64-bit)	n/a	x	n/a	n/a 1)	n/a 1)	n/a 1)
24	pulse-converter	x	n/a	x	x	n/a	x
25	event-log	n/a	n/a	n/a	x	x	x
27	trend-log-multiple	n/a 2)	n/a	n/a 2)	x	n/a	x
28	load-control	x	n/a	x	x	n/a	x
29	structured-view	n/a	x	n/a	n/a	x	n/a
42	date-value	n/a	x	x	n/a	x	x
45	integer-value	n/a	x	x	n/a	x	x
48	positive-integer-value	n/a	x	x	n/a	x	x
50	time-value	n/a	x	x	n/a	x	x
52	alert-enrollment	n/a	x	x	n/a	x	x
200	hierarchy	x	n/a	n/a	x	n/a	n/a
201	block	x	n/a	n/a	x	n/a	n/a
207	access-control-profile	n/a	n/a	n/a	x	n/a	n/a
208	discipline-io	n/a	n/a	n/a	x	n/a	n/a
211	group-object	n/a	n/a	n/a	x	n/a	n/a
214	cmn-alarm	n/a	n/a	n/a	x	n/a	n/a
216	command	n/a	n/a	n/a	x	n/a	n/a
217	device-info	n/a	n/a	n/a	x	n/a	n/a
256	group-member	n/a	n/a	n/a	n/a	x	n/a
257	group-master	n/a	n/a	n/a	n/a	x	n/a
258	blind-output	n/a	x 3)	n/a	n/a	x	n/a
259	blind-input	n/a	x 3)	n/a	n/a	x	n/a
260	analog-lighting-output	n/a	x 3)	n/a	n/a	x	n/a
261	binary-lighting-output	n/a	x 3)	n/a	n/a	x	n/a
262	lighting-input	n/a	x 3)	n/a	n/a	x	n/a
263	application-configuration	n/a	n/a	n/a	n/a	x	n/a
264	network-port	n/a	n/a	n/a	n/a	x	n/a

x Object supported

n/a Object not supported

n/a 1) 64 bit accumulator is shown up to 32 bits then it will be showing an incorrect value

n/a 2) Not shown as explicit object but through icon indication and trendlog app

x 3) Only supported in listview and graphics view



Issued by  
Siemens Switzerland Ltd  
Smart Infrastructure  
Global Headquarters  
Theilerstrasse 1a  
CH-6300 Zug  
+41 58 724 2424  
[www.siemens.com/buildingtechnologies](http://www.siemens.com/buildingtechnologies)

© Siemens Switzerland Ltd, 2019  
Technical specifications and availability subject to change without notice.