

Desigo™ TRA

Fume Hood Operating Display Panel

QMX3.P87



The Operating Display Panel (ODP) is the interface between the operator and the DXR Fume Hood Controller (FHC).

- LCD display for volume flow setpoint, face velocity setpoint and alarms
- Alarm and warning notifications
- Silence alarm button
- Multiple operator selectable setpoints
- Control of fume hood light
- Energy Efficiency function "Green Leaf"
- Interface KNX PL-Link (for TRA, with plug & play functionality)
- Powered by KNX PL-Link
- Auxiliary keys (8 programmable)

Features

- Digital display of face velocity in meters per second (mps) or feet per minute (Fpm)
- Digital display of exhaust airflow in cubic meters per hour (m³/h), cubic feet per minute (cfm) and liters per second (l/s)
- Green, yellow and red LED status lights
- Alarm horn with dedicated silence alarm button
- Emergency max push button

Use

The KNX Operating Display Panel (QMX3.P87) is the interface between the fume hood operator and the control system. It includes a custom designed package for visual and audible indication of fume hood operating conditions and push-buttons for emergency mode operation, alarm silence and user defined auxiliary buttons. The panel is mounted on the wall or fume hood in an easily accessible location. Up to two Operating Display Panels are supported per Fume Hood Controller.

Functions

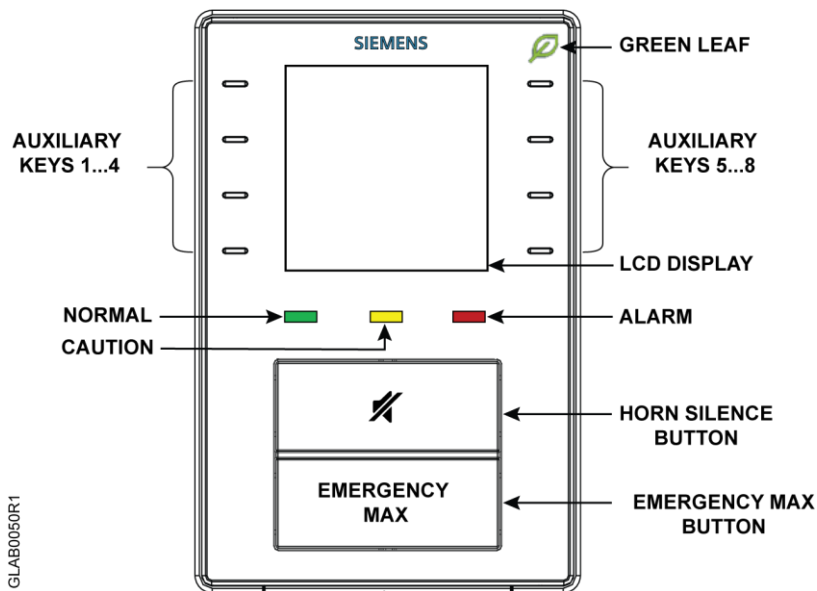

Visual Indicators	Meaning	Action
	Fume hood is operating efficiently	None
	Action required	Press Key 5 to return to energy efficient operation, check display for instructions
Green LED - Solid	Normal operation, no alarms or warnings present	None
Green LED - Flashing	Pending change to Low air volume flow mode Fume hood is operating in Low airflow mode, no alarms or warning present	Follow lab safety procedures
Yellow LED - Solid	High airflow warning Low airflow warning Sash open above maximum operating position Stabilizing jet fan failure	Follow lab safety procedures for high airflow warning indication Follow lab safety procedures for low airflow warning indication Close sash to a safe operating position Follow lab safety procedures for stabilizing jet fan failure
Yellow LED - Flashing	Fume hood use for lab room exceeded	Close fume hood sash to reduce fume hood exhaust

Visual Indicators	Meaning	Action
Red LED	High airflow alarm Low airflow alarm Emergency purge Airflow measuring or sash measuring device failure Fume hood has been decommissioned Fire High exhaust air temperature	Follow lab safety procedures

Audible Information	Meaning	Action
Constant buzz	High airflow alarm Low airflow alarm Emergency purge Airflow measuring or sash measuring device failure Fire	Follow lab safety procedures
Long buzz	Sash open above maximum operating position	Close sash to safe operating position
Short buzz	Pending change to Low air volume flow mode	Follow lab safety procedures
Five buzz/minute	Sash opening alert	Close fume hood sash to reduce fume hood exhaust

Buttons/Controls	Meaning	Action
Horn Silence	Mutes audible alarm	None
EMERGENCY MAX	Rapid exhaust of fume hood contents in a spill situation	If there is a spill, push button, lower sash, and follow lab safety procedures

Technical design

Mechanical design

The unit always communicates as a KNX PL-Link device. Up to two operator display units can be connected to the same controller.

The operating and display unit can perform the following functions without a controller:

- Monitoring of the communication to the controller. The green and yellow LEDs go off in the event of communication failure. The red alarm LED is activated.

Components

- Segmented backlit display.
- "Green Leaf" energy efficiency function.
- Three status LEDs.
- Eight auxiliary buttons to support sash closure, light switches, and setpoint adjustment.
- Alarm buzzer.
- Horn silence button.
- Emergency max button.
- Communication port.

The details of the functions of the elements are specified by the application of the connected controller.

Type summary

Type	Stock number	Designation
QMX3.P87-1WSC	S55624-H111	Fume hood operating display panel

Delivery

The following items are packaged with product:

- Installation instructions
- KNX terminal block
- Screws (6)

Product documentation

Topic	Title	Document ID:
Installation/Mounting	Wall mounted sensor and room operator units for KNX PL-Link	CM2M1602xx
Engineering and commissioning, workflow	ABT online help	n.a.
Commissioning	User's guide: Setup & Service Assistant (SSA)	CA111050

Related documents such as environmental declarations, CE declarations, etc., can be downloaded at the following Internet address:

<http://siemens.com/bt/download>

Notes

Security

	⚠ CAUTION
	National safety regulations Failure to comply with national safety regulations may result in personal injury and property damage <ul style="list-style-type: none">• Observe national provisions and comply with the appropriate safety regulations.

Engineering

Fume hood automation

The unit complies with the requirements for a fume hood operating device (see Conformity). Volume flow control, monitoring and light control can be implemented and automated for a fume hood together with a fume hood controller.

Flexible use

The functionality of the buttons, LEDs and alarm buzzer is defined by the application in the controller that controls the operator display unit. This ensures that the unit can be flexibly used.

Mounting

The mounting plate is designed for the fume hoods with or without existing cutouts.

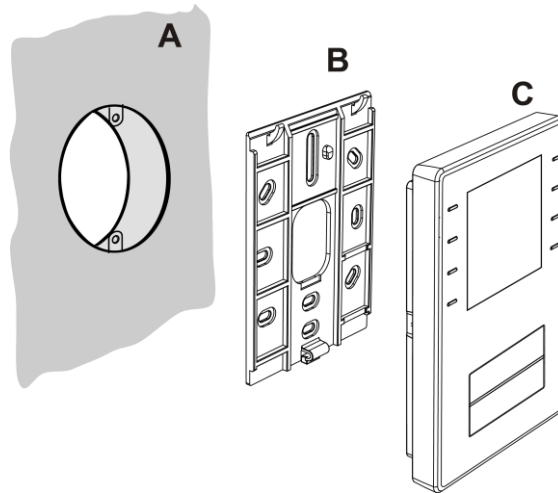

FUM0570R1

- designed for fume hood or wall-mounting. A conduit box is optional (A).
- base plate (B) has screw holes for all commercially available conduit boxes. The height of the screw heads must not exceed 3 mm.
- ODP device (C).

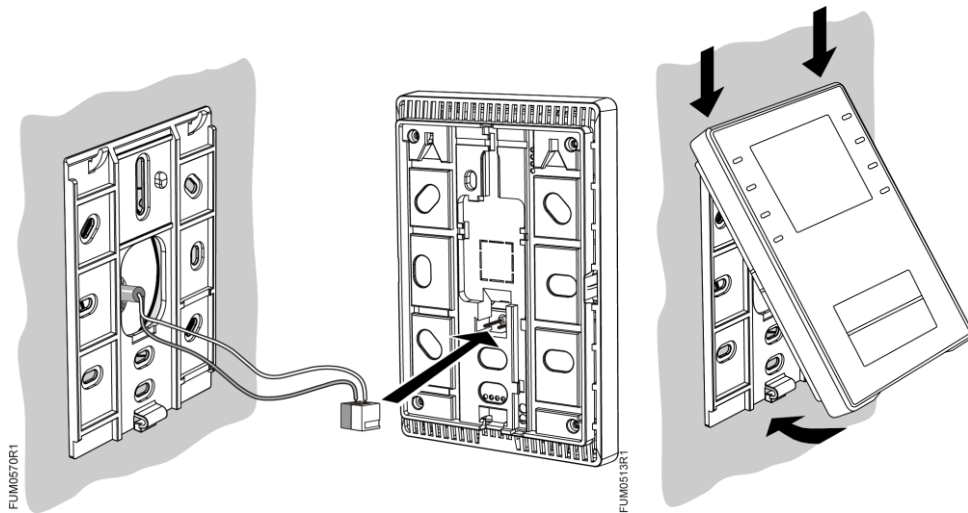

FUM0570R1

FUM0513R1

Installation

- For KNX PL-Link wiring (topology, allowed cables and cable length), see the Desigo TRA installation guide, CM111043.
- Use the correct cables for the KNX PL-Link bus
- Do not interchange the wires of the KNX PL-Link cable.
 - The red terminal is for KNX PL-Link +
 - The gray terminal is for KNX PL-Link –
- Observe all local installation regulations.



⚠ CAUTION

The devices are not protected against accidental connection to AC 230 V.

The fume hood operating panel displays the current condition of the fume hood by illuminating one of its three status LEDs. The average face velocity of the fume hood can be displayed in ft/min or m/s.

During an abnormal operating condition, the QMX3.P87 displays various messages to alert you of the condition.

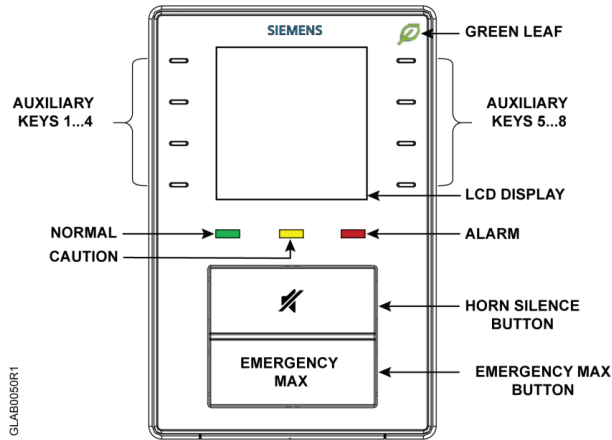

Horn silence button

Pressing the Horn Silence button will turn the internal audible alarm off for the current alarm event.

Emergency max button

Emergency max automatically overrides any other control mode in the Fume hood controller.

Pressing the Emergency max button will remove contaminated air from the fume hood by switching to an emergency exhaust flow level.

The internal audible alarm will sound.

Pressing the Emergency max button a second time reverts the FHC to normal operation for the current conditions.

Display layout of fume hood operating display panel

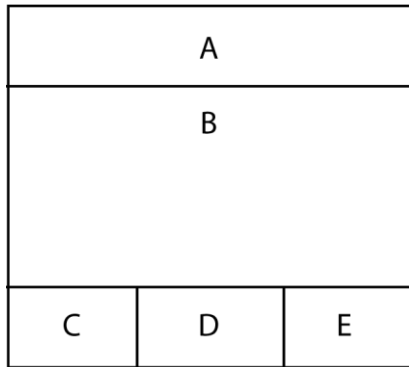

- A - text messages
- B - setpoint, actual value, dynamic icon or text
- C - light display
- D - audible state display
- E - sash close display

Function of the display elements and keys

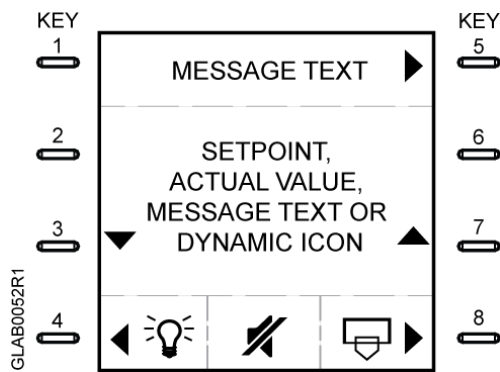

	An arrow indicates that an element can be operated
	Fume hood setpoint selection (Key 3 or Key 7): Off, Auto, Setpoint 1, Setpoint 2, Setpoint 3
	Dynamic close the sash
	Horn silence
	Fume hood light (Key 4)
	Automatic sash closing (Key 8)
Advanced settings	Press keys 1 and 8 simultaneously for 5 seconds <ul style="list-style-type: none"> • Exit (Key 5) • Menu select (Key 2 or Key 6) • Setting select (Key 3 or Key 7)

Auxiliary Keys

Eight auxiliary keys are available for user defined programming.

Key 1 – Programmable for LSSB (Light switching sensor basic) operation*

Key 2 – Programmable for LSSB operation*

Key 3 – Manual setpoint adjustment or programmable for LSSB operation*

Key 4 – Fume hood light**

Key 5 – Green leaf reset

Key 6 – Programmable for LSSB operation*

Key 7 – Manual setpoint adjustment or programmable for LSSB operation*

Key 8 – Automatic sash closing**

*ABT Pro is required to program buttons for LSSB.

**Optional. Additional hardware and configuration required.

Connecting KNX

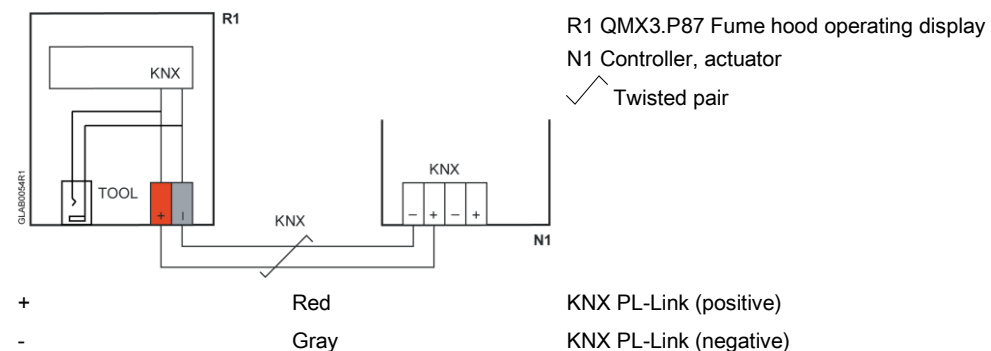

Note

The device is protected against faulty wiring but communications will not work on interchanged wires.

Tool plug

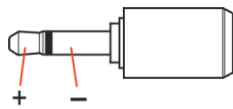

2.5 mm Jack

Tool cable RJ45 plug

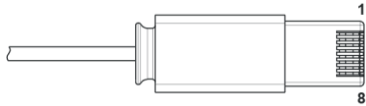

1 CE+, KNX	5 Voltage 16 V
2 CE-, KNX	6 N.C.
3 N.C.	7 Identification pin
4 N.C.	8 GND

Connecting tool

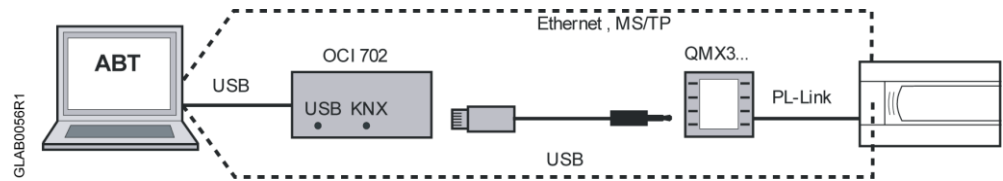

Connect the ABT to load the application in the room automation station, or for service purposes:

- Directly to the room automation station.
- To the room unit using the tool cable and the OCI702 service interface (see data sheet A6V10438951).

Commissioning KNX

When only one device is connected to the KNX PL-Link bus, the operating display panel automatically establishes communications with the Fume hood controller, from where the functions are downloaded to the operating display panel (plug & play).

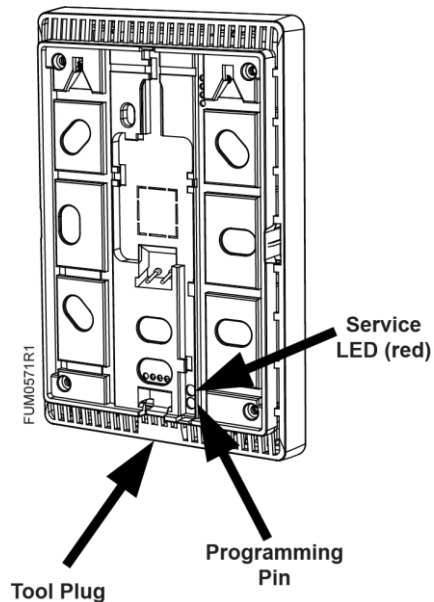

Addressing:

1. Short press the programming pin (<0.5 sec).
The device goes into programming mode; the service LED is continuously on.
The tool identifies the current operating display panel that is operated and assigns it.
2. After the device is commissioned, deactivate the programming mode by shortly pressing the programming pin (<0.5 s). The service LED goes off.

Note: Programming mode resets to "disabled" each time the device restarts.

Factory reset:

1. Long press the programming pin (>20 s). The device is locked and reboots within 10 seconds. The Fume hood controller deletes it from its device list. During this time, it is safe to remove the device from the network.
If the bus plug remains connected, the device acts like a newly inserted device requiring again automated or manual configuration.

Note: This operation resets all user preference data and configuration settings to factory default. This operation is irreversible.

Disposal

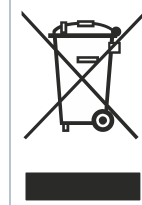

The device is considered an electronics device for disposal in terms of European Directive 2012/19/EU and may not be disposed of as domestic garbage.

- Dispose of the device through channels provided for this purpose.
- Comply with all local and currently applicable laws and regulations.

Warranty

Technical data on specific applications are valid only together with Siemens products listed under "Equipment combinations". Siemens rejects any and all warranties in the event that third-party products are used.

Dimensions and Weight	
Dimensions	140 mm x 80 mm x 39 mm (5.5in H x 3.125in W x 1.5in D)
Weight	226 g (8 oz.)
Specifications	
Face Velocity Display Range	0 ... 3937 Fpm (0.01 ... 20 m/s)
Face Velocity Display Resolution	1 fpm, adjustable (0.01 m/s)
Exhaust Air Volume Flow Display Range	0 ... 126400 cfm (0 ... 214748 m ³ /h)
Exhaust Air Volume Flow Display Resolution	1 cfm, adjustable (1 m ³ /h)
Push-Buttons/Switch inputs	1 Emergency ax 1 Horn silence 8 Auxiliary Keys
Alarm Horn	85 dB @ 10 cm (4 in)
Power supply	
Supply voltage	Operating voltage range KNX / PL-Link DC 21...30 VDC
Power consumption from room automation station	Max 8 mA at DC 24 V
Interfaces	
KNX PL-Link	Type: KNX TP1, galvanic isolation. Baud rate: 9.6 kbps. Short-circuit proof. Protection against faulty wiring at max. AC 24 V.
Wiring connections	
Cable type	TP-1 Twisted Pair Min. 0.8 mm (AWG20) Max. 1.0 mm (AWG18)
Wiring lengths for signals.	KNX PL-Link 80 m (262.5 ft) with internal bus power or 300 m (984.3 ft) with external power supply.
Ambient conditions and protection classification	
Classification as per EN 60730 Function of automatic control devices Degree of contamination Overvoltage category	Type 1 2 III.
Design type	Device suited for use with equipment of safety classes I and II.
Degree of protection of housing to EN 60529	IP20.
Climatic ambient conditions <ul style="list-style-type: none"> • Transport (packaged for transport) as per EN 60721-3-2 • Operation as per EN 60721-3-3 	<ul style="list-style-type: none"> • Class 2K3 Temperature -25...70 °C (-13... 158 °F) Air humidity 5...95%. • Class 3K5 Temperature -5...50 °C (23... 122 °F) Air humidity 5...95%.
Mechanical ambient conditions Transport as per EN 60721-3-2 Operation as per EN 60721-3-3	Class 2M2. Class 3M2.

Standards, directives and approvals	
Product standard - Automatic electrical controls for household and similar use	IEC/UL/EN 60730-1 , part H.23 Emission and H.26 Immunity
Product Standard - General requirements for Home and Building Electronic Systems (HBES)	EN 50491-5-1, EN 50491-5-2, EN 50491-5-3
Electromagnetic compatibility – generic immunity standard, Industrial environment	Immunity IEC/EN 61000-6-2
Electromagnetic compatibility – generic emission standard, Domestic, commercial, light industry.	Emission IEC/EN 61000-6-3
EU conformity (CE)	DoC Document number: A5W90001444
EAC compliance	Eurasien compliance for all QMX3.P... variants
RCM conformity	AS/NZS 61000-6-3 : 2012 DoC Document number: A5W90001445
UL Approbation	UL 916 PAZX Energy Management Equipment, http://database.ul.com
Federal Communications Commission*	FCC CFR 47 Part 15 Subpart B Class B
CSA and cUL	C22.2 No. 205 Signal Equipment
ICES-003	CAN ICES-3 (B) / NMB-3 (B)
Environmental compatibility	The product environmental declaration contains data on environmentally compatible product design and assessments (RoHS compliance, materials composition, packaging, environmental benefit, disposal).

* This equipment has been tested and found to comply with the limits for a Class B digital device, pursuant to part 15 of the FCC Rules. These limits are designed to provide reasonable protection against harmful interference in a residential installation. This equipment generates, uses and can radiate radio frequency energy and, if not installed and used in accordance with the instructions, may cause harmful interference to radio communications. However, there is no guarantee that interference will not occur in a particular installation. If this equipment does cause harmful interference to radio or television reception, which can be determined by turning the equipment off and on, the user is encouraged to try to correct the interference by one or more of the following measures:

- Reorient or relocate the receiving antenna.
- Increase the separation between the equipment and receiver.
- Connect the equipment into an outlet on a circuit different from that to which the receiver is connected.
- Consult the dealer or an experienced radio/TV technician for help.

This device complies with Part 15 of the FCC Rules. Operation is subject to the following two conditions: (1) this device may not cause harmful interference, and (2) this device must accept any interference received, including interference that may cause undesired operation.

Dimensions

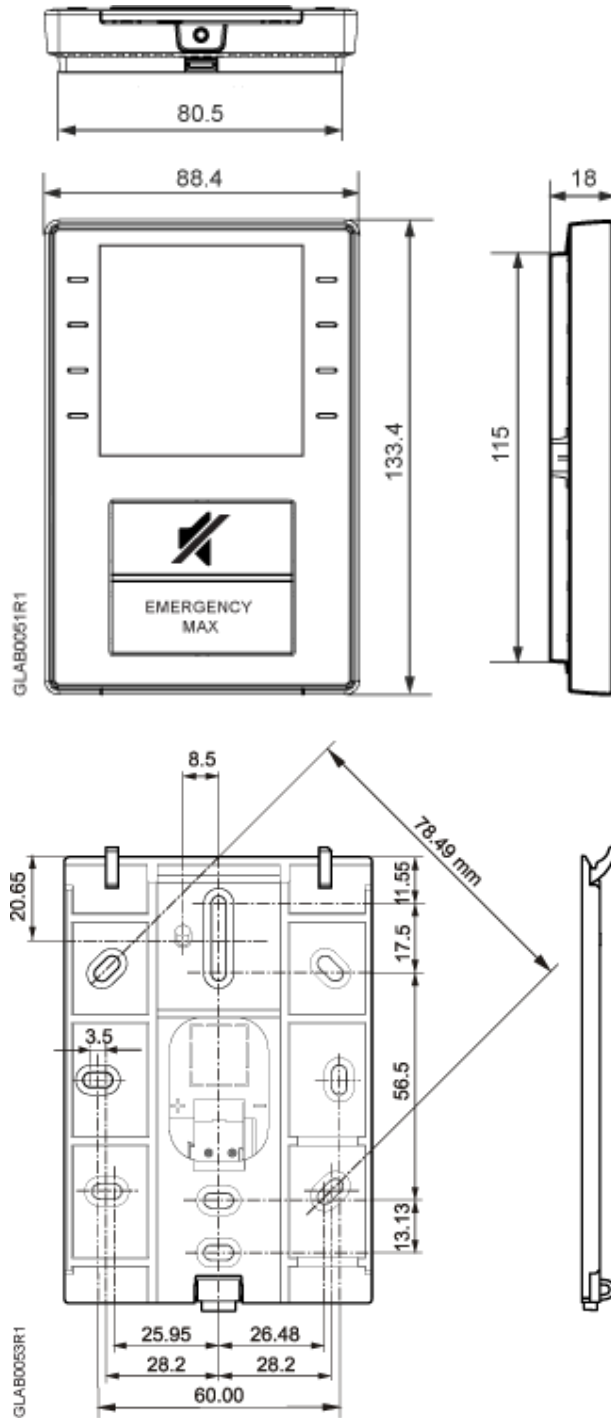

Issued by
Siemens Industry, Inc.
Building Technologies Division
1000 Deerfield Pkwy
Buffalo Grove IL 60089
Tel. +1 847-215-1000

© Siemens Industry, Inc., 2017
Technical specifications and availability subject to change without notice.