

OpenAir™

VAV compact controller BACnet MS/TP

G..B181.1E/BA



VAV compact controllers 5 / 10 Nm with BACnet MS/TP communication

- GDB181.1E/BA Operating voltage AC 24 V, 5 Nm
- GLB181.1E/BA Operating voltage AC 24 V, 10 Nm

- For plants with constant or variable air volume flow control:
 - Supply air control or extract air control
 - Supply and extract air control with ratio control 1:1, or ratio control for positive or negative pressure
- AC 24 V operating voltage
- Quasi-static sensor 0..300 Pa operating range
- 5 and 10 Nm torque
- BACnet MS/TP communication, BTL listed
- Volume flow control or position control
- UL listed

VAV compact controllers are not suitable for environments where the air is saturated with sticky or fatty particles or contain aggressive substances.

Function	Description
BACnet MS/TP communication	BACnet MS/TP (RS-485), galvanically separated
Functions	<ul style="list-style-type: none"> - Setpoint 0..100% - Actual values for volume flow, position and differential pressure - Volume flow or position control - Override control Open / Close / Min / Max / Stop - Setpoint monitoring and backup mode
Supported baudrates	9.6, 19.2, 38.4, 57.6, 78.4, 115.2 kbaud
Termination	120 kΩ electronically switchable
BACnet profile	B-ASC (Application-specific controller)

Product no.	Stock no.	Operating voltage	Positioning signal	Power consumption	Posit. time	Manual adjuster	Position feedback
GDB181.1E/BA	S55499-D168	AC 24 V	BACnet MS/TP	1 VA / 0.5 W	150 s	Yes	True position potentiometer
GLB181.1E/BA	S55499-D169			3 VA / 2.5 W ¹⁾			

Please refer to data sheet **N4698** for information on accessories and spare parts.

¹⁾ Actuator rotates

Ordering (Example)

Product no.	Stock no.	Description	Quantity
GDB181.1E/BA	S55499-D168	VAV compact controller BACnet	1

The manufacturer of VAV box units (OEM) generally configures and assembles VAV compact controllers. VAV control core parameters are therefore protected against unauthorized changes after production. For configuration and maintenance the service tools AST20 (handheld tool) or ACS931 / ACS941 (PC tool, to be used with AST11) are available.

Equipment combinations

Product no.	Stock no.	Description	Doc. type	Doc. number
AST20	S55499-D165	Handheld tool for commissioning and service	Datasheet	A6V10631836
			Operating manual	A6V10555077
AST11		Interface converter for ACS941 / ACS931	Datasheet	N5852
ACS931		PC tool for commissioning and service (OEM version)	Datasheet	N5853
ACS941		PC tool for commissioning and service (Service version)	Datasheet	N5854

Title	Topic	Document ID
VAV compact controllers BACnet MS/TP	Detailed information about the VAV compact controllers with BACnet MS/TP communication	A6V10631864
Installation Instruction VAV Modbus / BACnet	Mounting / installation instruction	A6V10523083
BACnet PICS	BACnet Protocol Implementation Conformance Statement	A6V10644636

Related documents such as environmental declarations, CE declarations, etc., can be downloaded at the following Internet address:

<http://siemens.com/bt/download>

Safety

Caution

National safety regulations

Failure to comply with national safety regulations may result in personal injury and property damage.

- Observe national provisions and comply with the appropriate safety regulations.

Push-button operation

Activity	Push-button operation	Confirmation
Display current address (in reverse order)	Press button < 1s	Current address is displayed
Enter push-button addressing mode	Press button > 1s and < 5s	Red LED shines (release button before LED gets dark)
Reset to factory settings	Press button > 10s	Orange LED flashes

LED colors and patterns

Color	Pattern	Description
Green	steady	Start-up
	1s on / 5s off	Fault free operation ("life pulse")
	flashing	Bus traffic
Orange	1s on / 5s off	Backup mode entered
Red	Steady	Mechanical fault / device jammed
	flashing fast	Sensor error: Pressure tubes interchanged or „Invalid configuration“
	flashing slowly	Sensor error: Internal read error
	1s on / 5s off	Internal error

Resetting the device by push button

The VAV compact controllers can be reset by push-button:

1. Press button for >10s → LED starts flashing **orange**
2. Release button while LED still flashes → LED keeps flashing for 3s
3. After those 3s → LED shines **red** (reset), then **green** (start-up).

A factory reset by push-button leads to a reset of all parameters as described in the section "Settings and operating mode" to the OEM default values. Since these values can be set by the OEM, they are not necessarily the same as the Siemens factory settings.

All other parameters, especially the bus parameters, are reset to Siemens factory settings.

VAV compact controllers can also be reset by the VAV handheld tool AST20 or over bus. Please refer to the corresponding operating manual / technical basics.

Display current address (digits in reverse order)

The BACnet address can be set without a separate tool by using the push-button and LED.

To display the current address, press button <1s.

Colors		
1-digits: red	10-digits: green	100-digits: orange

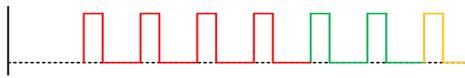
Example for address 124:	
LED	
Note	The address is entered and shown in reverse order.

Set new address (digits in reverse order)

1. **Enter addressing mode:** press button > 1s until LED shines **red**, then release button (before LED gets dark).
2. **Enter digits:** press button n-times → LED flashes per button press (feedback).
Colors: 1-digits: **red** / 10-digits: **green** / 100-digits: **orange**
3. **Store digits:** press button until LED shines in color of following digits – release button,
4. **Save address:** press button until LED shines **red** (confirmation) → release button.
An address can be stored at any time, i.e. after setting the 1-digits, or after setting the 1- and the 10-digits.
5. Entered address is repeated one times for confirmation.

Note: If button is released before LED shines red, the address is discarded.

Examples

Set address “124”:

1. Enter addressing mode
2. Set 1-digits: Press button 4-times → LED flashes **red** per button press
3. Store 1-digits: press button until LED shines **green** – release button
4. Set 10-digits: Press button 2-times → LED flashes **green** per button press
5. Store 10-digits: press button until LED shines **orange** – release button
6. Set 100-digits: Press button 1-times → LED flashes **orange** per button press
7. Store address: press button until LED shines **red** – release button
→ address is stored and displayed 1x for confirmation

Set address “50”:

1. Enter addressing mode
2. Skip 1-digits: Hold button pressed until LED shines **green** – release button
3. Set 10-digits: Press button 5-times → LED flashes **green** per button press
4. Store address (skip 100-digits): hold button pressed until LED shines **red** – release button
→ address is stored and displayed 1x for confirmation

Set address “5”:

1. Enter addressing mode
2. Set 1-digits: Press button 5-times → LED flashes **green** per button press
3. Store address: press button until LED shines **red**
→ address is stored and displayed 1x for confirmation

Parameterization

The OEM generally provides the basic configuration to VAV compact controllers, especially the parameter Vn and the opening direction. The setting of all other parameters depends on the actual application and can be obtained from the ventilation planner or similar.

The following parameters must be checked or set prior to commissioning:

Parameter	Range	Description	Factory setting
Operating mode	VAV (flow ctrl.) / POS (position ctrl.)	Interpretation of setpoint VAV = setpoint commands volume flow [%] POS = setpoint commands damper position [%]	VAV
Opening direction	CW (R) / CCW (L)	Opening direction of air damper	CW (R)
Adaptive positioning	Off / On	Adaption of actual opening range to position feedback Off = No adaption / mapping 0°..90° → 0..100 % On = Pos. adaption / mapping e.g. 0°..60° → 0..100 %	Off
Vmax	20...120%	Maximum air volume flow	100 %
Vmin	-20...100%	Minimum air volume flow	0 %
Vnom	0...60'000 m ³ /h	Nominal air volume flow ¹⁾	100 m ³ /h
Vn	1...3.16	Characteristic value for the air volume flow; set by the manufacturer (OEM)	1
Altitude	0...5000m in 500m steps	Altitude level correction factor for differential pressure sensor (select n*500m value closest to real altitude)	500 meters

Please refer to technical basics **A6V10631864** for more explanation.

¹⁾ Value used for displaying / not used for volume flow control loop

Variable air volume (VAV) control

The operating point is determined by the setpoint value and the Vmin / Vmax settings.

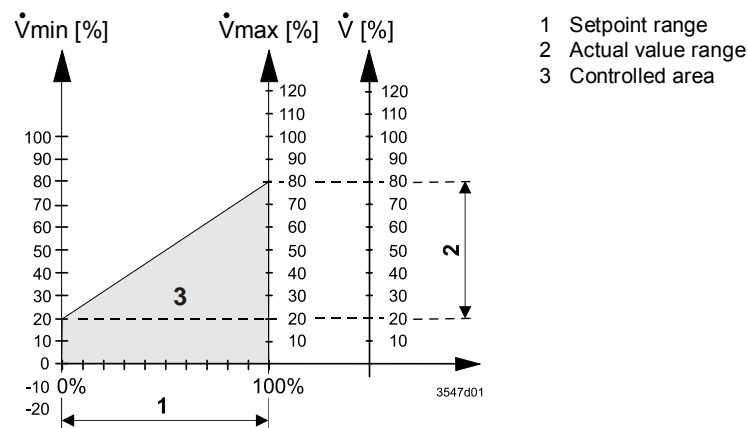

Constant air volume (CAV) control

A constant air volume flow can be achieved by sending a constant setpoint value.

Position control

The VAV compact controllers can be operated as damper actuators, i.e. using the 0..100% setpoint as position damper setpoint, by setting the operating mode parameter to "POS".

Engineering

Engineering mainly consists of implementing the data model into a VAV application, especially sending the setpoint from the supervisory controller to the VAV compact controller, and receiving the actual values (flow and position) for monitoring and optimization. System limitations of BACnet MS/TP apply, especially number of devices per segment and cable lengths depending on the baudrate.

Commissioning

Two basic workflows are supported:

- Full or partial configuration (bus configuration and optionally VAV parameters configuration) by a tool (AST20 or ACS941),
- Full or partial configuration over bus, usually using addressing by push-button, with subsequent configuration over bus.

Commissioning workflow 1: Full or partial configuration by tool

When using the AST20 handheld tool or the ACS931 / ACS941 PC tool, all bus and VAV parameters can be set.

- Connect AST20 or ACS931 / ACS941 (for PC tools, use AST11 interface converter) to the VAV compact controller and navigate to the bus configuration menu,
- Set bus parameters as desired,
- Optionally make changes on VAV parameters.

Note

With AST20, all parameters can be set using the mass configuration function. The bus parameters are included in the mass configuration function. It can be selected that the address is automatically incremented with each programmed VAV compact controller. ACS931 / ACS941 supports saving and loading of parameter sets.

Commissioning workflow 2: Configuration over bus (full or partially)

The devices can be configured over bus (not using a separate configuration tool like in workflow 1) if the factory settings allow for a connection between a BACnet programming tool (e.g. a BACnet browser) and peripheral devices.

Preconditions:

- No address must be present on the bus in more than one instance.
- Baudrate and format must match with the settings of the programming tool.

→ Option A, full configuration over bus: Only one device at a time is connected to the bus and powered up. The device is then accessed by the BACnet programming / configuration tool (using the default address) and the address and other parameters are set to the definitive values.

→ Option B, partial configuration over bus: All devices are powered up and connected to the bus before commissioning. Then all devices must have different addresses (using the push-button addressing method described above).

Mounting

Mounting positions

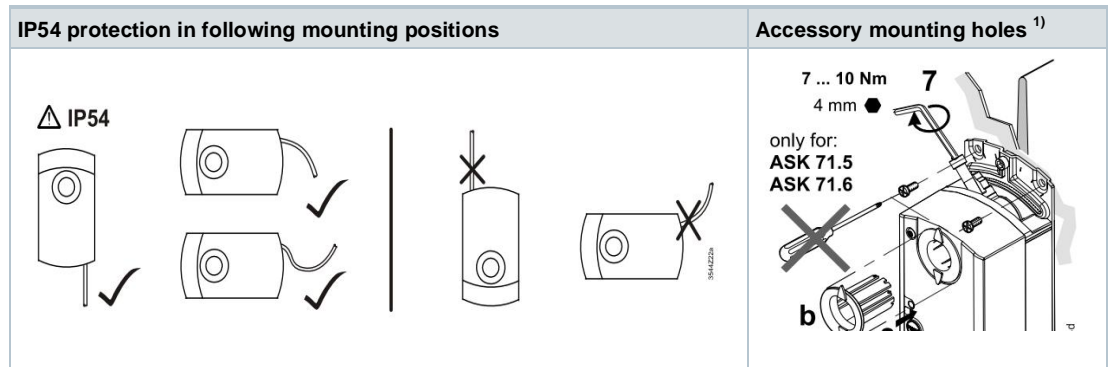

 ¹⁾ Not to be used for fixation of the actuator, use anti-rotation-bracket instead.

Maintenance

The VAV compact controllers are maintenance-free.

Mounting:

- Do not open the VAV compact controllers
- Do not use the accessory mounting holes for fixation of the VAV compact controllers
- If necessary, disconnect electrical connections from the terminals

The VAV compact controllers must be correctly adjusted to the VAV box before commissioning.

Disposal

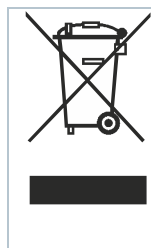

The device is considered electrical and electronic equipment for disposal in terms of the applicable European Directive and may not be disposed of as domestic garbage.

- Dispose of the device through channels provided for this purpose.
- Comply with all local and currently applicable laws and regulations.

Technical data on specific applications are valid only together with Siemens products listed under "Equipment combinations". Siemens rejects any and all warranties in the event that third-party products are used.

Note

When using the actuators in connection with components of other manufactures, correct functioning must be ensured by the user, and Siemens will assume no responsibility.

Power supply		
Operating voltage	G..B181.1E/..	AC 24 V ± 20 % (SELV) or AC 24 V class 2 (US)
Frequency		50/60 Hz
Power consumption	at 50 Hz	
	Actuator holds	1 VA / 0.5 W
	Actuator rotates	3 VA / 2.5 W

Function data		
Positioning time for nominal rotation angle	G..B181.1E/..	150 s (50 Hz) 120 s (60 Hz)
Nominal torque	GDB..	5 Nm
	GLB..	10 Nm
Maximum torque	GDB..	< 7 Nm
	GLB..	< 14 Nm
Nominal / maximum rotation angle		90° / 95° ± 2°
Direction of rotation	Adjustable by tool or over bus	Clockwise (CW) / Counter-clockwise (CCW)

Connection cables		
Cable length		0.9 m
Power supply	Number of cores and cross-sectional area	2 x 0.75 mm ²
Communication	Number of cores and cross-sectional area	3 x 0.75 mm ²
Service interface	Terminal strip	7-pin, grid 2.00 mm

Communication		
Communication protocol	BACnet MS/TP	RS-485, galv. separated
	Number of nodes	Max. 32
	Address range	0...128 Default: 1
	Transmission format	1-8-N-1
	Max. master	1...127 Default: 127
	Device object ID	0...4193404 Default: 10000
	Baudrates (kBaud)	Auto / 9.6 / 19.2 / 38.4 / 57.6 / 76.8 / 115.2 Default: Auto
	Termination	120 Ω electronically switchable Default: Off

Please refer to the PICS A6V10644636 ¹⁾ for a detailed description of the BACnet implementation

Degree of protection		
Degree of protection	Degree of protection acc. to EN 60529 (see mounting instruction)	IP54
Safety class	Safety class acc. to EN 60730	III

Environmental conditions		
Applicable standard		IEC 60721-3-x
Operation	Climatic conditions	Class 3K5
	Mounting location	Indoors
	Temperature general	0...50 °C
	Humidity (non condensing)	5...95 % r. F.
Transport	Climatic conditions	Class 2K3
	Temperature	-25...70 °C
	Humidity	5...95 % r. h.
Storage	Climatic conditions	Class 1K3
	Temperature	-5...45 °C
	Humidity	5...95 % r. h.

Directives and Standards		
Product standard		EN 60730-x
Product family standard		EN 50491-3, EN 50491-5 General requirements for Home and Building Electronic Systems (HBES) and Building Automation and Control Systems (BACS)
Building automation and control systems (BACS) - Part 2 Hardware		EN ISO 16848-2
Electromagnetic compatibility (Application)		For residential, commercial and industrial environments
EU Conformity (CE)		GDB181.1E/BA
		GLB181.1E/BA
RCM Conformity		A5W00003842 ¹⁾
		A5W00000176 ¹⁾
UL, cUL	AC 24 V	GDB181.1E/BA
		GLB181.1E/BA
		A5W00003843 ¹⁾
		A5W00000177 ¹⁾
		UL 873 http://ul.com/database

Environmental compatibility		
		The product environmental declaration A6V10209938 ¹⁾ contains data on environmentally compatible product design and assessments (RoHS compliance, materials composition, packaging, environmental benefit, disposal).

Dimensions / Weight		
Weight	Without packaging	0.6 kg
Dimensions		71 x 158 x 61 mm
Suitable drive shafts	Round shaft (with centering element)	8...16 mm (8...10 mm)
	Square shaft	6...12.8 mm
	Min. drive shaft length	30 mm
	Max. shaft hardness	<300 HV

Air volume flow controller		
Type	3-position controller with hysteresis	
Vmax, adjustable	resolution 1% / factory setting 100%	20%...120%
Vmin, adjustable	resolution 1% / factory setting 0%	-20%...100%
Vn = f(dp _n), adjustable	resolution 0.01 / factory setting 1.00	1.0...3.16

Differential pressure sensor		
	Connection tubes (Interior diameter)	3...8 mm
	Measuring range	0...500 Pa
	Operating range	0...300 Pa
Precision at 23 °C, 966 mbar and optional mounting position	Zero point	± 0.2 Pa
	Amplitude	± 4.5 % of the measured value
	Drift	± 0.1 Pa / Year
	Max. permissible operating pressure	3000 Pa
	Max. permissible overload on one side	3000 Pa

¹⁾ The documents can be downloaded from <http://siemens.com/bt/download>

Internal diagrams

The VAV compact controller is supplied with two prewired connecting and communication cables.

G..B181.1E/BA

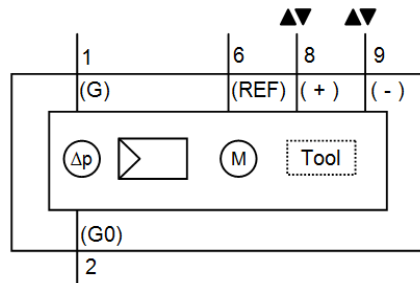

Tool = Configuration and maintenance interface
(7-pin)

Power supply and communication cables

Core designation	Core color	Terminal code	Description
Cable 1: Power / black sheathing			
1	red (RD)	G	System voltage AC 24 V
2	black (BK)	G0	System neutral AC 24 V
Cable 2: Communication / blue sheathing			
6	violet (VT)	REF	Reference
8	grey (GY)	+	Bus (BACnet MS/TP)
9	pink (PK)	-	Bus (BACnet MS/TP)

Note

The operating voltage at terminals G and G0 must comply with the requirements under SELV or PELV.

Safety transformers with twofold insulation as per EN 61558 required; they must be designed to be on 100 % of the time.

G..B181.1E/..

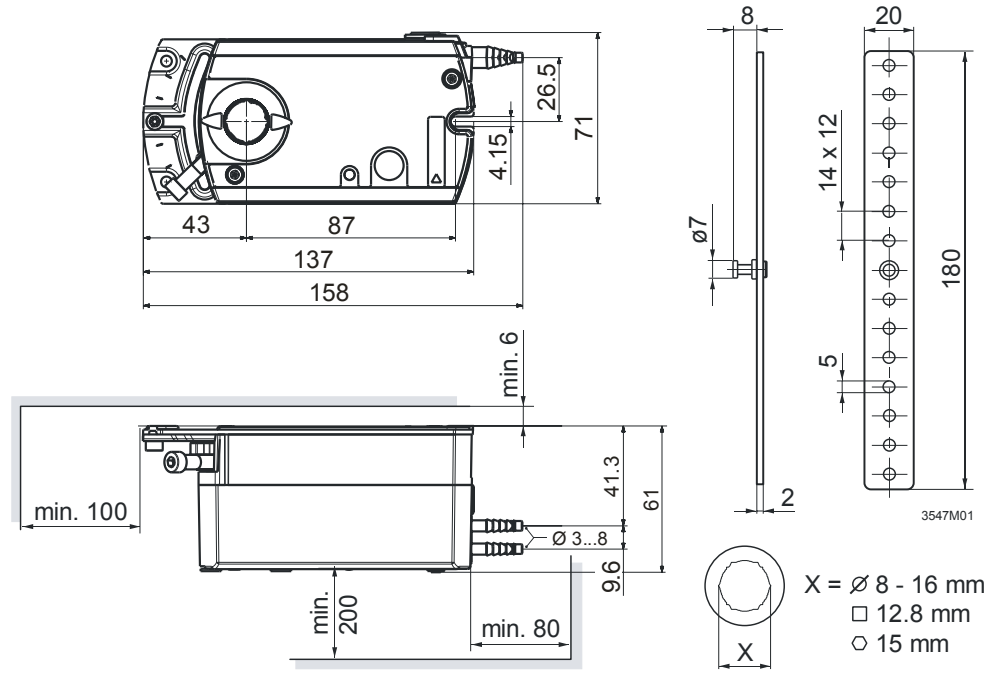

Measurements in mm

Issued by
Siemens Switzerland Ltd
Building Technologies Division
International Headquarters
Theilerstrasse 1a
6300 Zug
Switzerland
Tel. +41 58-724 24 24
www.siemens.com/buildingtechnologies

© Siemens Switzerland Ltd, 2015
Technical specifications and availability subject to change without notice.

Document ID A6V10631834_en--_d
Issue 2018-04-16