



VVI47...



VXI47...

ACVATIX™

2-port and 3-port seat valves, PN16

VVI47..
VXI47..

with internally threaded connections

-
- Bronze valve body CC491K (Rg5)
 - DN 15...50
 - k_{vs} 2.5...40 m³/h
 - Internally threaded connections Rp.. as to ISO 7-1
 - Can be equipped with SBX...- electromotoric

Use

For use in heating, in ventilating and air conditioning systems as a control or safety shutoff valve. For open and closed circuits (mind Cavitation, refer to page 4).

Type summary

Product number		DN	k _{vs} [m ³ /h]	S _v
2-port	3-port			
VVI47.15-2.5	VXI47.15-2.5	15	2.5	> 50
VVI47.15-4	VXI47.15-4	15	4.0	
VVI47.20-6.3	VXI47.20-6.3	20	6.3	> 100
VVI47.25-10	VXI47.25-10	25	10	
VVI47.32-16	VXI47.32-16	32	16	
VVI47.40-25	VXI47.40-25	40	25	
VVI47.50-40	VXI47.50-40	50	40	

DN = Nominal size

k_{vs} = Nominal flow rate of cold water (5...30 °C) through the fully open valve (H₁₀₀), by a differential pressure of 100 kPa (1 bar)

S_v = Rangeability k_{vs} / k_{vr} as per VDI 2173

k_{vr} = The lowest value for k_v at which the characteristic tolerance is still maintained, at a differential pressure of 100kPa (1 bar)

Ordering

Example:

Product number	Stock number	Designation	Quantity
VVI47.25-10	VVI47.25-10	2-port seat valve PN16 with internally threaded connection	1

Delivery

Valves, actuators and accessories are packed and supplied separately.

Equipment combinations

Valves		H ₁₀₀ [mm]	Actuators SBX..				
			Δp _{max} [kPa]	Δp _{max} ¹⁾ [kPa]	Δp _s ²⁾ [kPa]		
VVI47.15-2.5	VXI47.15-2.5	20	400	100	1600		
VVI47.15-4	VXI47.15-4						
VVI47.20-6.3	VXI47.20-6.3						
VVI47.25-10	VXI47.25-10				300	1550	
VVI47.32-16	VXI47.32-16						875
VVI47.40-25	VXI47.40-25						
VVI47.50-40	VXI47.50-40		300	300			

¹⁾ For 3-port valves in diverting function, max. 100 kPa is recommended. If noise is permitted, the same values apply as for mixing applications.

²⁾ Valid for 2-port valves only

Δp_{max} = Maximum permissible differential pressure across the valve's control path, valid for the entire actuating range of the motorized valve (maximum recommended operating differential pressure)

Δp_s = Maximum permissible differential pressure at which the motorized valve will close securely against the pressure (close off pressure)

Actuator overview

Product number	Actuator type	Operating voltage	Positioning signal	Spring return function	Positioning	
					time	force
SBX31	Electro-motoric	AC 230 V	3-position	-	120 s	700 N
SBX81		AC/DC 24 V				
SBX61			DC 0...10 V ¹⁾			

¹⁾ or DC 4...20 mA or 0...1000 Ω



For VXI47.. the application is only possible if the valve is used as mixing valve.

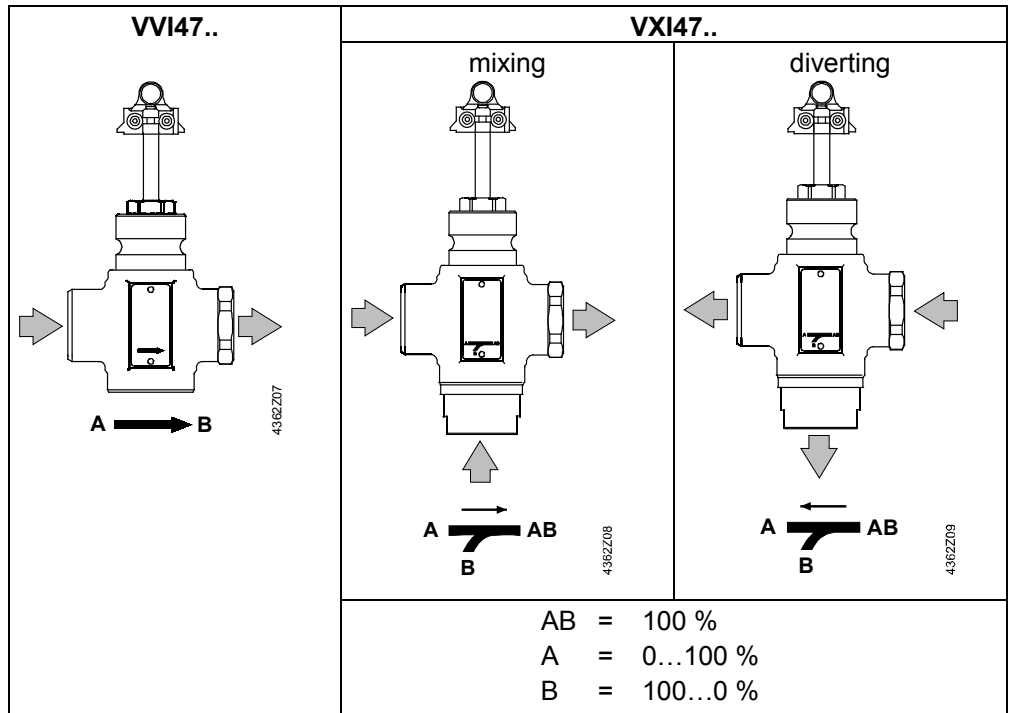

⚠ The 2-port seat valve does not become a 3-port valve by removing the blank fitting.

Sizing

Flow diagram

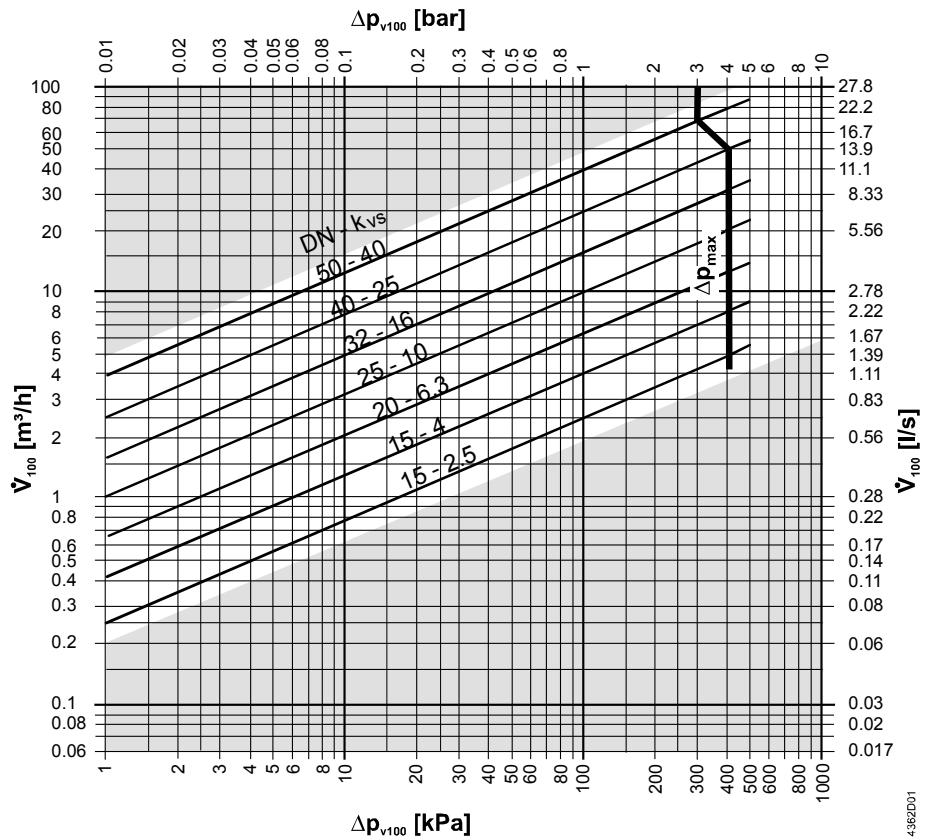

Δp_{v100} = Differential pressure across the fully open valve and the valve's control path by a Volumetric flow \dot{V}_{100}

\dot{V}_{100} = Volumetric flow through the fully open valve (H₁₀₀)

100 kPa = 1 bar ≈ 10 mWG

1 m³/h = 0.278 l/s water at 20 °C

Valve flow characteristics

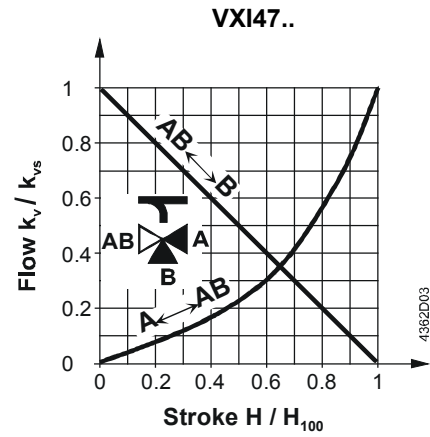
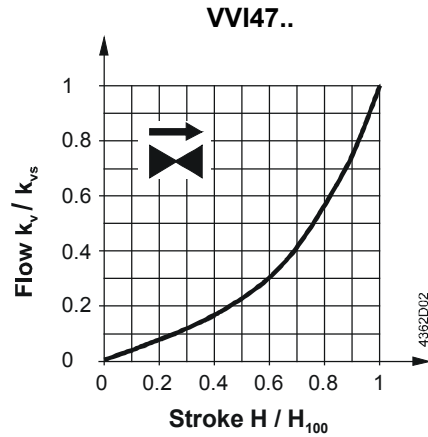

Cavitation

Cavitation accelerates wear on the valve plug and seat, and also results in undesirable noise. Cavitation can be avoided by not exceeding the differential pressure shown in the "Working pressure and medium temperature" on page 5, and by adhering to the static pressures shown below.

Note on chilled water

To avoid cavitation in chilled water circuits ensure sufficient counter pressure at valve outlet, e.g. by a throttling valve after the heat exchanger. Select the pressure drop across the valve at maximum according to the 80 °C curve in the flow.

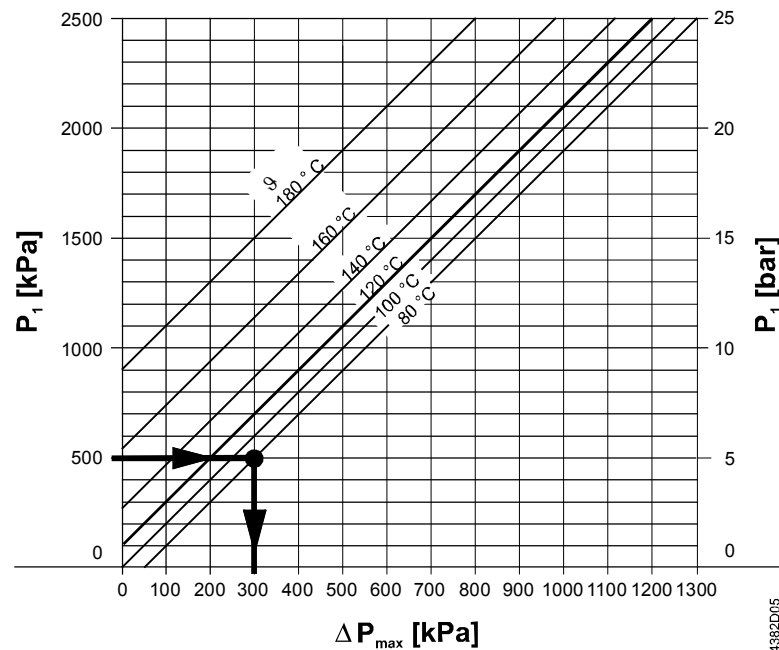

- Δp_{\max} = Differential pressure with valve almost closed, at which cavitation can largely be avoided
- p_1 = Static pressure at inlet
- p_3 = Static pressure at outlet
- M = Pump
- ϑ = Water temperature

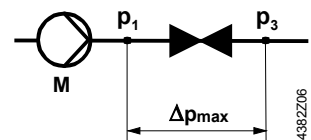

Hot water example:

Pressure p_1 at valve inlet: 500 kPa (5 bar)
 Water temperature: 80 °C

From the diagram above, it will be seen that with the valve almost closed, the maximum permissible differential pressure Δp_{\max} is 300 kPa (3 bar).

Chilled water example:

Spring water cooling as an example of avoiding cavitation:

- Chilled water = 12 °C
- p_1 = 500 kPa (5 bar)
- p_4 = 100 kPa (1 bar) atmospheric pressure
- Δp_{max} = 300 kPa (3 bar)
- $\Delta p_{3-3'}$ = 20 kPa (0.2 bar)
- Δp_D (throttle) = 80 kPa (0.8 bar)
- $p_{3'}$ = pressure after consumer in kPa

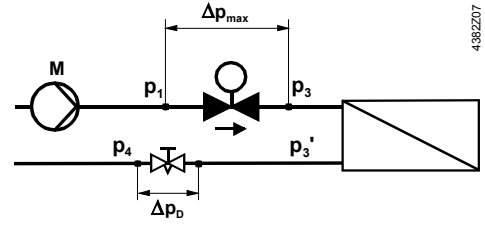

Working pressure and medium temperature

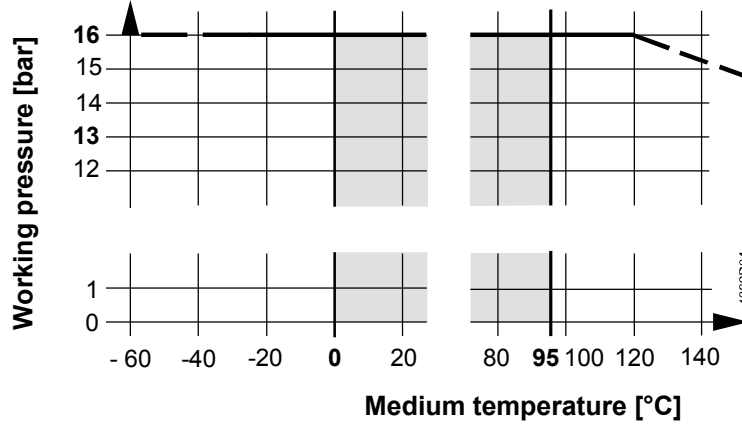

Working pressure and medium temperature staged as per ISO 7005.

Current local legislation must be observed.

Notes

Engineering

We recommend installation in the return pipe, as the temperatures in this pipe are lower for applications in heating systems, which in turn, extends the stem sealing gland's life.
Water quality requirements as per VDI 2035.



We generally recommend to install a strainer to increase the valve's functional safety.

Mainly use VXI47...as 3-port mixing valve.

Mounting

Both valve and actuator can easily be assembled at the mounting location. Neither special tools nor adjustments are required.
The valve is supplied with mounting instructions no. 7431909080

Mounting positions

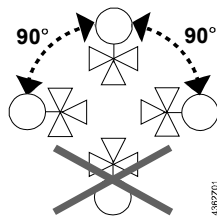

Direction of flow

When mounting, pay attention to the valve's flow direction symbol →:

2-port	3-port mixing	3-port diverting
A → B	A → AB B	A ← AB B

Commissioning



Commission the valve only if the actuator has been mounted correctly.

Stem retracts:	Increasing flow	Through-port opens, bypass closes
Stem extends:	Decreasing flow	Through-port closes, bypass opens

Maintenance



For actuator service work: Turn off the pump and the operating voltage, close the shutoff valves, depressurize the pipes and allow them to cool down. Disconnect the electrical connections, where required, from the terminals. Re-commission the valve only if the actuator has been mounted correctly.

Disposal

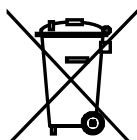

The valve must be dismantled and separated into its various constituent materials before disposal.

Observe all local and applicable laws.

Warranty

The technical data supplied for these valves is valid only for valves used in conjunction with the actuators listed under "Equipment combinations".

Use with third-party actuators invalidates any warranty offered by Siemens Building Technologies / HVAC Products.

Technical data

Functional data	PN class	PN 16 to EN 1333
	Working pressure	to ISO 7005 within the permissible "Working pressure and medium temperature" range according to the diagram on page 5.
	Flow characteristic	
	Through port	0...30 % Linear
	Through port	30...100 % Equal percentage; $n_{gl} = 3$ to VDI / VDE 2173
	Bypass (VXI47..)	0...100 % Linear
	Leakage rate	
	Through port	0...0.02 % of k_{vs} value to DIN EN 1349
	Bypass (VXI47..)	0.5 ... 2 % of k_{vs} value to DIN EN 1349
	Permissible media	water
	brine	
Medium temperature		0...95 °C
Rangeability S_v		DN 15: > 50 DN ≥ 20: > 100
Nominal stroke		20 mm
Industry standards	Pressure Equipment Directive	PED 97/23/EC
	Pressure Accessories	as per article 1, section 2.1.4
	Fluid group 2	without CE-marking as per article 3, section 3 (sound engineering practice)

Materials	Environmental compatibility	ISO 14001 (Environment) ISO 9001 (Quality) SN 36350 (Environmentally compatible products) RL 2002/95/EG (RoHS)
	Valve body	Bronze CC491K (Rg5)
	Plug	Brass
	Stem	Stainless steel
	Sealing gland	Brass
Dimensions / Weight	Gland materials	EPDM O rings, silicon-free
	Dimensions	Refer to "Dimensions"
	Connections	Internally threaded, Rp... to ISO 7-1
	Weight	Refer to "Dimensions"



S_v = Rangeability k_{vs} / k_{vr} as per VDI 2173

k_{vs} = Nominal flow rate of cold water (5...30 °C) through the fully open valve by a differential pressure of 100 kPa (1 bar)

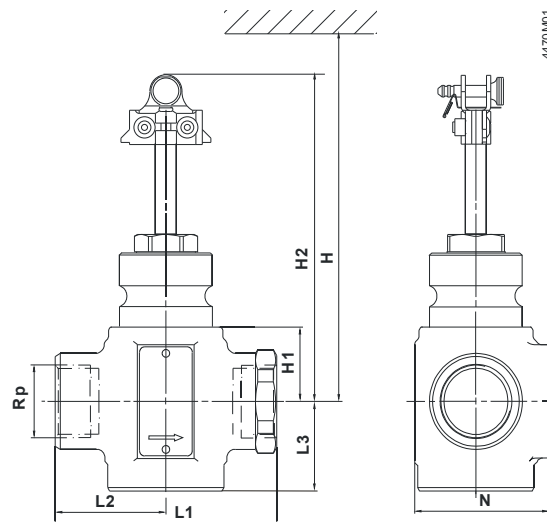

k_{vr} = The lowest value for k_v at which the characteristic tolerance is still maintained, at a differential pressure of 100 kPa (1 bar)

Dimensions

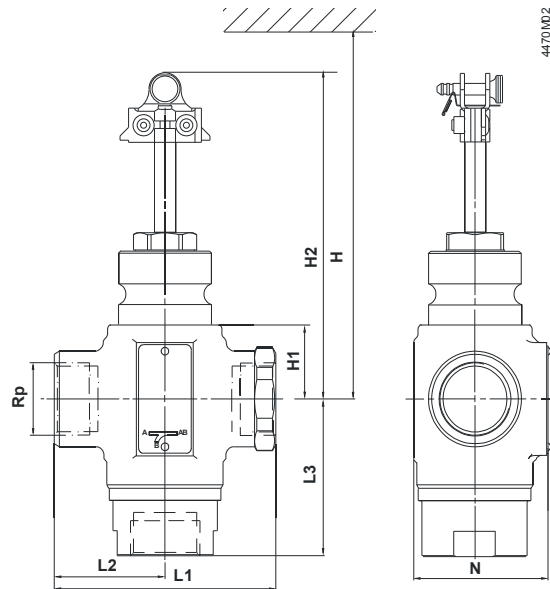

	DN	L1	L2	L3	H1	H2	H + SBX	G	N	 [kg]
		[mm]	[mm]	[mm]	[mm]	[mm]	[mm]	[inches]	[mm]	
VVI47.15 – 2.5	15	90	45	40	26	138.5	> 490	Rp½	60	1.34
VVI47.15 – 4	15	90	45	40	26	138.5		Rp½	60	1.34
VVI47.20 – 6.3	20	90	45	40	26	138.5		Rp¾	60	1.39
VVI47.25 – 10	25	105	52.5	41	34	146.5	> 500	Rp1	64	1.74
VVI47.32 – 16	32	115	57.5	41	34	146.5		Rp1¼	87	2.14
VVI47.40 – 25	40	130	65	46	46	158.5	> 510	Rp1½	108	2.79
VVI47.50 – 40	50	150	75	56	46	158.5		Rp2	120	3.74



	DN	L1	L2	L3	H1	H2	H + SBX	G	N	
		[mm]	[mm]	[mm]	[mm]	[mm]	[mm]	[inches]	[mm]	[kg]
VXI47.15 – 2.5	15	90	45	68	26	138.5	> 490	Rp $\frac{1}{2}$	60	1.54
VXI47.15 – 4	15	90	45	68	26	138.5		Rp $\frac{1}{2}$	60	1.54
VXI47.20 – 6.3	20	90	45	69	26	138.5		Rp $\frac{3}{4}$	60	1.64
VXI47.25 – 10	25	105	52.5	73.5	34	146.5	> 500	Rp1	64	2.14
VXI47.32 – 16	32	115	57.5	74	34	146.5		Rp1 $\frac{1}{4}$	87	2.34
VXI47.40 – 25	40	130	65	84	46	158.5	> 510	Rp1 $\frac{1}{2}$	108	3.14
VXI47.50 – 40	50	150	75	98	46	158.5		Rp2	120	4.14

Spare parts

Order numbers for spare parts

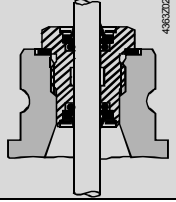
Product number		DN	Sealing gland 
VVI47.15-2.5	VXI47.15-2.5	15	4 284 8874 0
VVI47.15-4	VXI47.15-4	15	4 284 8874 0
VVI47.20-6.3	VXI47.20-6.3	20	4 284 8874 0
VVI47.25-10	VXI47.25-10	25	4 284 8874 0
VVI47.32-16	VXI47.32-16	32	4 284 8874 0
VVI47.40-25	VXI47.40-25	40	4 284 8874 0
VVI47.50-40	VXI47.50-40	50	4 284 8874 0

For these valves a plug replacement is not possible