

SIEMENS



Fire detection installations with
addressed detector lines in
potentially explosive
atmospheres

Planning
Mounting/ Installation
Commissioning
Maintenance

Legal notice

Technical specifications and availability subject to change without notice.

© 2011-2014 Copyright by Siemens Switzerland Ltd

Transmittal, reproduction, dissemination and/or editing of this document as well as utilization of its contents and communication thereof to others without express authorization are prohibited. Offenders will be held liable for payment of damages. All rights created by patent grant or registration of a utility model or design patent are reserved.

Issued by:

Siemens Switzerland Ltd.

Infrastructure & Cities Sector

Building Technologies Division

International Headquarters

Gubelstrasse 22

CH-6301 Zug

Tel. +41 41 724-2424

www.siemens.com/buildingtechnologies

Edition: 2014-05-23

Document ID: A6V10324618_g_en_--

Table of contents

1	About this document	5
1.1	Applicable documents.....	7
1.2	Download center.....	9
1.3	Technical terms, abbreviations, and symbols.....	9
1.4	History of changes.....	10
2	Safety	12
2.1	Safety instructions.....	12
2.2	Safety regulations for the method of operation.....	13
2.3	Standards and directives complied with.....	16
2.4	Release Notes.....	16
3	Principles	17
3.1	Prerequisites for an explosion.....	17
3.2	Primary, secondary, and structural explosion protection.....	18
3.3	Physical parameters.....	19
3.3.1	Flash point.....	19
3.3.2	Ignition temperature.....	19
3.3.3	Explosive mixture and explosion limits.....	19
3.4	Sources of ignition.....	20
3.5	Zone classification.....	20
3.6	Ignition protection category.....	22
3.6.1	Ignition protection category 'Intrinsic safety'.....	23
3.7	Classifying electrical equipment.....	24
3.7.1	Classification into device groups.....	24
3.7.2	Classification into device categories.....	25
3.7.3	Explosion groups and temperature classes.....	25
3.8	Labeling electrical equipment.....	26
4	Use of fire detectors in areas at risk of explosion	28
4.1	Intrinsically safe installation in accordance with EN 60079-14.....	28
4.2	Product range.....	29
4.2.1	Operating conditions.....	29
4.2.2	Line adapter (Ex) FDCL221-Ex.....	30
4.2.3	Point detector FDOOT241-A9-Ex.....	30
4.2.4	Point detector OOH740-A9-Ex.....	31
4.2.5	Manual call point FDM223-Ex.....	31
4.2.6	Simple electrical equipment.....	32
4.2.6.1	alarm indicators.....	32
4.3	Specifications and restrictions relating to FDnet-Ex and C-NET-Ex.....	33

5	Duties of the operator	34
5.1	Relevant legal regulations.....	34
5.1.1	Directive 94/9/EC.....	34
5.1.2	Directive 2014/34/EU.....	35
5.1.3	Directive 99/92/EC.....	35
5.2	Technical regulations and standards.....	36
5.3	Preparatory measures	37
5.4	Installation information.....	37
5.5	Technical documentation for testing and maintenance work.....	39
5.6	Qualifications of the testing personnel.....	40
5.7	Tests prior to first commissioning.....	40
5.8	Recurring tests	41
5.9	Repair	42
5.10	Special requirements for ignition protection category 'Intrinsic safety'	43
5.11	Maintenance.....	45
6	Mounting/Installation.....	46
6.1	Preparatory measures	46
6.2	Installation guidelines	47
6.3	Installation materials for zones 0, 1, and 2	48
6.4	Protective clearances for door and ventilation openings.....	49
6.5	Equipotential bonding	49
6.6	Intrinsically safe circuits with line adapter (Ex) FDCL221-Ex	51
6.7	External alarm indicators FDAI92-Ex and FDAI93-Ex.....	53
6.8	Grounding (fire detection and control lines).....	53
7	Commissioning.....	54
8	Maintenance/Servicing.....	55
8.1	Responsibilities and choosing personnel.....	55
9	Annex A - Sample calculation.....	56
9.1	Sample calculation	56
10	Annex B - PTB numbers for older safety barriers.....	62
	Glossary.....	63
	Index	65

1 About this document

Goal and purpose

This document describes the

- Planning
- Mounting and installation
- Commissioning
- Maintenance and servicing

of a fire detection installation FS20/FS720 with addressed detector lines in a potentially explosive atmosphere. In order to understand the information it contains, the reader must have a general awareness of the setup and function of the fire detection installation.

The document also contains information on the operator's obligations.



Please note the documents listed in the chapter 'Applicable documents [→ 7]'. These documents contain important information, which you must observe when planning, mounting, installing, commissioning, maintaining, and servicing a fire detection installation.

Scope

This document is aimed at users who will plan, install, commission, and maintain a fire detection installation FS20/FS720 within the scope of Directive 94/9/EC (ATEX 95).

The document does not describe the planning, installation or maintenance of a fire detection installation within the scope of NEC 500 and NEC 505 or CEC Section 18 and CEC Annex J.



The use of peripheral devices on collective detector lines and interactive detector lines in potentially explosive atmospheres is described in document 001204. See the chapter 'Applicable documents [→ 7]'.

Target groups

The information in this document is intended for the following target groups:

Target group	Activity	Qualification
Product Manager	<ul style="list-style-type: none"> ● Is responsible for information passing between the manufacturer and regional company. ● Coordinates the flow of information between the individual groups of people involved in a project. 	<ul style="list-style-type: none"> ● Has obtained suitable specialist training for the function and for the products. ● Has attended the training courses for Product Managers.
Project Manager	<ul style="list-style-type: none"> ● Coordinates the deployment of all persons and resources involved in the project according to schedule. ● Provides the information required to run the project. 	<ul style="list-style-type: none"> ● Has obtained suitable specialist training for the function and for the products. ● Has attended the training courses for Project Managers.
Project engineer	<ul style="list-style-type: none"> ● Sets parameters for product depending on specific national and/or customer requirements. ● Checks operability and approves the product for commissioning at the place of installation. ● Is responsible for trouble-shooting. 	<ul style="list-style-type: none"> ● Has obtained suitable specialist training for the function and for the products. ● Has attended the training courses for Product Engineer.
Installation personnel	<ul style="list-style-type: none"> ● Assembles and installs the product components at the place of installation. ● Carries out a performance check following installation. 	<ul style="list-style-type: none"> ● Has received specialist training in the area of building installation technology or electrical installations.
Maintenance personnel	<ul style="list-style-type: none"> ● Carries out all maintenance work. ● Checks that the products are in perfect working order. ● Searches for and corrects malfunctions. 	<ul style="list-style-type: none"> ● Has obtained suitable specialist training for the function and for the products.

There are various tasks that may only be performed by qualified persons in accordance with the national implementation of Directive 2009/104/EC (e.g. in Germany: Section 2 (7) of the Ordinance on Industrial Safety and Health (BetrSichV)).

Reference document and source language

- The source language of this document is German (de).
- The reference version of this document is the international version in English. The international version is not localized.

The reference document has the following designation:

ID_x_en_--

x = version, en = English, -- = international

Document identification

The document ID is structured as follows:

ID code	Examples
ID_ModificationIndex_Language_COUNTRY -- = multilingual or international	A6V10215123_a_de_DE A6V10215123_a_en_-- A6V10315123_a_--_--

Date format

The date format in the document corresponds to the recommendation of international standard ISO 8601 (format YYYY-MM-DD).

Conventions for text marking

Markups

Special markups are shown in this document as follows:

▷	Requirement for a behavior instruction
1. 2.	Behavior instruction with at least two operation sequences
–	Version, option, or detailed information for a behavior instruction
⇒	Intermediate result of a behavior instruction
⇨	End result of a behavior instruction
●	Numbered lists and behavior instructions with an operation sequence
[→ X]	Reference to a page number
'Text'	Quotation, reproduced identically
<Key>	Identification of keys

Supplementary information and tips



The 'i' symbol identifies supplementary information and tips for an easier way of working.

1.1 Applicable documents

Document ID	Name
001204	Principles, applications, installation, maintenance Fire alarm signal in areas at risk of explosion
008331	List of compatibility (for 'Sinteso™' product line)
008843	FS20 Fire detection system - Planning
A6V10210362	FS720 Fire detection system - Planning
A6V10229261	List of compatibility (for 'Cerberus™ PRO' product line)
A6V10260486	Installation Alarm indicators, adapter frame, surface-mounted housing, indicator housing, incl. washer FDAI92EX, FDAI93EX, AI330, DCA1191, DJZ1193
A6V10333771	Technical Manual Line adapter (Ex) FDCL221-Ex
A6V10346580	Technical Manual Automatic fire detector FDOOT241-A9-Ex
A6V10349345	Data sheet Automatic fire detector FDOOT241-A9-Ex
A6V10349347	Data sheet Manual call point FDM223-Ex
A6V10349349	Data sheet Line adapter (Ex) FDCL221-Ex

Document ID	Name
A6V10349616	Technical Manual Manual call point FDM223-Ex
A6V10349619	Installation Manual call point FDM223-Ex
A6V10349621	Installation Automatic fire detector FDOOT241-A9-Ex
A6V10349626	Installation Line adapter (Ex) FDCL221-Ex
A6V10367521	Technical Manual Automatic fire detector OOH740-A9-Ex
A6V10367523	Installation Automatic fire detector OOH740-A9-Ex
A6V10371417	Data sheet Automatic fire detector OOH740-A9-Ex

Please also observe the documentation for your fire detection system.

You will find more information on explosion protection in the following standards and directives:

Standards and directives	Title
2014/34/EU	Directive for harmonizing the legal regulations of Member States for equipment and protective systems intended for use in potentially explosive atmospheres (recast).
94/9/EC	Directive for harmonizing the legal regulations of Member States for equipment and protective systems intended for use in potentially explosive atmospheres.
99/92/EC	Directive on minimum requirements for improving the health and safety protection of workers potentially at risk from explosive atmospheres.
2009/104/EC	Use of Work Equipment Directive
67/548/EEC	Dangerous Substances Directive
IEC/EN 60079-0	Explosive atmospheres – Part 0: Equipment – General requirements
IEC/EN 60079-10	Explosive atmospheres – Part 10-1: Classification of areas – Explosive gas atmospheres Part 10-2: Classification of areas – Combustible dust atmospheres
IEC/EN 60079-11	Explosive atmospheres – Part 11: Equipment protection by intrinsic safety "I"
IEC/EN 60079-14	Explosive atmospheres – Part 14: Electrical installations design, selection and erection
IEC/EN 60079-17	Explosive atmospheres – Part 17: Electrical installations inspection and maintenance
IEC/EN 60079-19	Explosive atmospheres – Part 19: Equipment repair, overhaul and reclamation
IEC/EN 60079-25	Explosive atmospheres – Part 25: Intrinsically safe electrical systems
EN 1127-1	Explosive atmospheres – Explosion prevention and protection – Part 1: Basic concepts and methodology

You must observe the national regulations for setting up installations in potentially explosive atmospheres in addition to the standards and directives stated above.

1.2 Download center

You can download various types of documents, such as data sheets, installation instructions, and license texts via the following Internet address:

<http://siemens.com/bt/download>

- Enter the document ID in the 'Find by keywords' input box.



You will also find information about search variants and links to mobile applications (apps) for various systems on the home page.

1.3 Technical terms, abbreviations, and symbols

Term	Explanation
AI	Alarm indicator
BetrSichV	Betriebsicherheitsverordnung, national implementation in the Federal Republic of Germany of Directive 2009/104/EC on the use of work equipment
CEC	Canadian Electrical Code
EPL	Equipment Protection Level
FDnet-Ex/C-NET-Ex	Addressed detector line
FDnet-Ex/C-NET-Ex	Addressed detector line in a potentially explosive atmosphere downstream of a line adapter (Ex) FDCL221-Ex
FDnet-Ex/C-NET-ExMK	Maximal current connection factor on the FDnet-Ex/C-NET-Ex
LED	Light Emitting Diode
TN system	Terre Neutre system, low-voltage system for the electrical power supply
VbF	Verordnung über brennbare Flüssigkeiten (flammable liquids ordinance)

Symbol	Meaning
C_o	Maximum external capacity
C_c	Maximum permissible cable capacitance
C_i	Maximum internal capacity
I_o	Maximum output current
I_i	Maximum input current
L_o	Maximum external inductivity
L_c	Maximum permissible cable inductance
L_i	Maximum internal inductivity
P_o	Maximum output power
P_i	Maximum input power
R_c	Resistance of the connection cable
T_a	Ambient temperature in a potentially explosive atmosphere

Symbol	Meaning
U_i	Maximum input voltage
U_m	Maximum r.m.s. value of the alternating voltage. Maximum permissible voltage of an associated item of electrical equipment without canceling the energy limitation.
U_0	Maximum output voltage

You will find more technical terms in the glossary at the end of this document.

1.4 History of changes

The reference document's version applies to all languages into which the reference document is translated.



The first edition of a language version or a country variant may, for example, be version 'd' instead of 'a' if the reference document is already this version.

The table below shows this document's history of changes:

Modification index	Edtion date	Brief description
g	2014-05-23	Reference to the download center added; new Directive 2014/34/EU taken into account; point detector FDOOT241-A9ExCN removed from the document; editorial changes
f	2013-07-31	Editorial changes
e	2013-04-30	Editorial changes
d	2013-03-04	Document title changed; editorial changes; ATEX approvals added
c	2012-08-24	Editorial changes throughout the document, changes to the units of measurement used in the calculation example
b	2012-06-15	Editorial changes throughout the document, change to date format in line with ISO 8601 specifications (yyyy-mm-dd format).
a	12.2011	First edition



The language versions and country variants produced by a local company have the same modification index as the corresponding reference document. They are not however included in the table below.



The table below shows the published language versions with the corresponding modification index:

Modification index	en_--	de_--	fr_--	it_--	es_--
g	X	X	X	X	X
f	X	X	-	-	-
e	-	X	-	-	-
d	-	X	-	-	-
c	-	X	-	-	-
b	-	X	-	-	-
a	-	X	-	-	-

X = published

- = no publication with this modification index

2 Safety

	 WARNING
	<p>Contradictory safety instructions</p> <p>Risk of explosion caused by disregarding safety instructions</p> <ul style="list-style-type: none"> Should safety instructions relating to explosion protection contradict other safety instructions, please observe the safety instructions relating to explosion protection.

2.1 Safety instructions

The safety notices must be observed in order to protect people and property.

The safety notices in this document contain the following elements:







- Symbol for danger
- Signal word
- Nature and origin of the danger
- Consequences if the danger occurs
- Measures or prohibitions for danger avoidance

Symbol for danger

	<p>This is the symbol for danger. It warns of risks of injury.</p> <p>Follow all measures identified by this symbol to avoid injury or death.</p>
---	--

Additional danger symbols

These symbols indicate general dangers, the type of danger or possible consequences, measures and prohibitions, examples of which are shown in the following table:

	General danger		Explosive atmosphere
	Voltage/electric shock		Laser light
	Battery		Heat

Signal word

The signal word classifies the danger as defined in the following table:

Signal word	Danger level
DANGER	DANGER identifies a dangerous situation, which will result directly in death or serious injury if you do not avoid this situation.
WARNING	WARNING identifies a dangerous situation, which may result in death or serious injury if you do not avoid this situation.
CAUTION	CAUTION identifies a dangerous situation, which could result in slight to moderately serious injury if you do not avoid this situation.
<i>NOTICE</i>	<i>NOTICE</i> identifies possible damage to property that may result from non-observance.

How risk of injury is presented

Information about the risk of injury is shown as follows:

	▲ WARNING
	Nature and origin of the danger Consequences if the danger occurs <ul style="list-style-type: none"> • Measures / prohibitions for danger avoidance

How possible damage to property is presented

Information about possible damage to property is shown as follows:

	NOTICE
	Nature and origin of the danger Consequences if the danger occurs <ul style="list-style-type: none"> • Measures / prohibitions for danger avoidance

2.2 Safety regulations for the method of operation

National standards, regulations and legislation

Siemens products are developed and produced in compliance with the relevant European and international safety standards. Should additional national or local safety standards or legislation concerning the planning, assembly, installation, operation or disposal of the product apply at the place of operation, then these must also be taken into account together with the safety regulations in the product documentation.

Electrical installations

	⚠ WARNING
	<p>Electrical voltage Electric shock</p> <ul style="list-style-type: none"> • Work on electrical installations may only be carried out by qualified electricians or by instructed persons working under the guidance and supervision of a qualified electrician, in accordance with the electrotechnical regulations.

- Wherever possible disconnect products from the power supply when carrying out commissioning, maintenance or repair work on them.
- Lock volt-free areas to prevent them being switched back on again by mistake.
- Label the connection terminals with external external voltage using a 'DANGER External voltage' sign.
- Route mains connections to products separately and fuse them with their own, clearly marked fuse.
- Fit an easily accessible disconnecting device in accordance with IEC 60950-1 outside the installation.
- Produce earthing as stated in local safety regulations.

Assembly, installation, commissioning and maintenance

- If you require tools such as a ladder, these must be safe and must be intended for the work in hand.
- When starting the fire control panel ensure that unstable conditions cannot arise.
- Ensure that all points listed in the 'Testing the product operability' section below are observed.
- You may only set controls to normal function when the product operability has been completely tested and the system has been handed over to the customer.

	⚠ WARNING
	<p>Work carried out by personnel who are not qualified Risk of explosion</p> <ul style="list-style-type: none"> • Work in potentially explosive areas may only be carried out by qualified specialists or by specially instructed persons, in accordance with the national and international directives and regulations.

- You must only mount, install, and test the devices if the atmosphere in the area is not at risk of explosion.

Testing the product operability

- Prevent the remote transmission from triggering erroneously.
- If testing building installations or activating devices from third-party companies, you must collaborate with the people appointed.
- The activation of fire control installations for test purposes must not cause injury to anyone or damage to the building installations. The following instructions must be observed:
- Use the correct potential for activation; this is generally the potential of the building installation.
- Only check controls up to the interface (relay with blocking option).
- Make sure that only the controls to be tested are activated.
- Inform people before testing the alarm devices and allow for possible panic responses.
- Inform people about any noise or mist which may be produced.
- Before testing the remote transmission, inform the corresponding alarm and fault signal receiving stations.

Modifications to the system design and the products

Modifications to the system and to individual products may lead to faults, malfunctioning and safety risks. Written confirmation must be obtained from Siemens and the corresponding safety bodies for modifications or additions. No changes may be made to devices with EC-type examination certificates.

Modules and spare parts

- Components and spare parts must comply with the technical specifications defined by Siemens. Only use products specified or recommended by Siemens.
- Only use fuses with the specified fuse characteristics.
- Wrong battery types and improper battery changing lead to a risk of explosion. Only use the same battery type or an equivalent battery type recommended by Siemens.
- Batteries must be disposed of in an environmentally friendly manner. Observe national guidelines and regulations.

Disregard of the safety regulations

Before they are delivered, Siemens products are tested to ensure they function correctly when used properly. Siemens disclaims all liability for damage or injuries caused by the incorrect application of the instructions or the disregard of danger warnings contained in the documentation. This applies in particular to the following damage:

- Personal injuries or damage to property caused by improper use and incorrect application
- Personal injuries or damage to property caused by disregarding safety instructions in the documentation or on the product
- Personal injury or damage to property caused by poor maintenance or lack of maintenance

Disclaimer

We have checked that the content of this document matches the hardware and software described. Despite this, we cannot rule out deviations and cannot therefore assume liability for them matching completely. The details in this document are checked regularly and any corrections needed included in subsequent editions.



We are grateful for any suggestions for improvement.

2.3 Standards and directives complied with

A list of the standards and directives complied with is available from your Siemens contact.

2.4 Release Notes

Limitations to the configuration or use of devices in a fire detection installation with a particular firmware version are possible.

	⚠ WARNING
	<p>Limited or non-existent fire detection</p> <p>Personal injury and damage to property in the event of a fire.</p> <ul style="list-style-type: none"> • Read the 'Release Notes' before you plan and/or configure a fire detection installation. • Read the 'Release Notes' before you carry out a firmware update to a fire detection installation.

	NOTICE
	<p>Incorrect planning and/or configuration</p> <p>Important standards and specifications are not satisfied. Fire detection installation is not accepted for commissioning. Additional expense resulting from necessary new planning and/or configuration.</p> <ul style="list-style-type: none"> • Read the 'Release Notes' before you plan and/or configure a fire detection installation. • Read the 'Release Notes' before you carry out a firmware update to a fire detection installation.

3 Principles

In many industries, the tasks of manufacturing, processing, transporting, and storing combustible materials cause gases, vapor, or mist to be created or emitted and then released into the surrounding environment.

When these come into contact with oxygen in the air, the result may be a potentially explosive atmosphere that could lead to an explosion if it is ignited.

In cases where areas with a potentially explosive atmosphere are being monitored using fire detection methods, the electrical equipment used for this purpose must comply with certain safety requirements. Even during the process of planning a fire detection installation, there are several points that have to be considered in order to ensure the electrical equipment can operate safely.

The chapters that follow will take a more detailed look at the physical principles behind an explosion, as well as the resulting measures that manufacturers and operators have to take in order to prevent damage and injury.

3.1 Prerequisites for an explosion

A sudden chemical reaction between a flammable substance and oxygen which releases a large amount of energy results in an explosion.

Flammable substances may be:

- Gases
- Mists
- Vapors
- Dusts

An explosion can only take place when three factors converge:

- Flammable substance of an appropriate distribution and concentration
- Oxygen
 - Atmospheric oxygen
 - Oxygen from chemical compounds
- Source of ignition
 - Sparks
 - Electric arcs
 - Hot surfaces

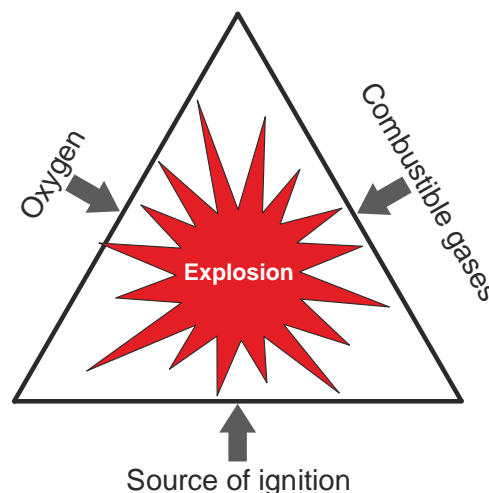

Explosion triangle

3.2 Primary, secondary, and structural explosion protection

The principle of integrated explosion protection requires all the relevant explosion protection measures to be taken in a specific order.

We draw a distinction between primary and secondary protective measures, as well as structural explosion protection.

Primary explosion protection

Primary explosion protection refers to all measures that prevent a potentially explosive atmosphere from being created in the first place.

Possible measures include:

- Avoiding the use of combustible materials
- Inert rendering by adding N₂ or CO₂, for example, to the potentially explosive atmosphere
- Restricting concentrations
- Improving ventilation

Secondary explosion protection

Secondary explosion protection covers protective measures that are designed to minimize the risk of an explosion. Secondary explosion protection is required in cases where it is not possible, or only possible to an extent, for primary explosion protection measures to eliminate the risk of an explosion.

Possible measures include:

- Preventing sources of ignition

Structural explosion protection

Structural explosion protection covers measures that restrict the effects of an explosion to a harmless level.

Possible measures include:

- Installing overpressure flaps
- Installing flame overvoltage protectors

3.3 Physical parameters

3.3.1 Flash point

For flammable liquids, the flash point specifies the lowest temperature at which a vapor-air mixture that can be ignited by spark ignition forms above the liquid level. If the flash point of such a flammable liquid is significantly higher than the maximum temperatures that occur, no potentially explosive atmosphere can be created there.



However, the flash point of a mixture of different liquids can also be lower than the flash point of the individual components.

Since 01.01.2003 liquids have been categorized into the following hazard classes in accordance with Directive 67/548/EEC:

Hazard class	Flash point
F+	Extremely flammable liquids with a flash point <0 °C
F	Highly flammable liquids with a flash point of 0...21 °C
R10	Flammable liquids with a flash point of 21...55 °C

3.3.2 Ignition temperature

The ignition temperature is the lowest temperature to which a surface has to be heated in order for a combustible substance to ignite spontaneously in the presence of oxygen without ignition sparks.

The ignition temperature thus represents the lowest temperature at which a hot surface can ignite a potentially explosive atmosphere.

3.3.3 Explosive mixture and explosion limits

A potentially explosive atmosphere forms when one or more combustible substances are present within a particular concentration range.

Lean mixture

When the concentration of the combustible substance in the atmosphere is too low, the mixture is said to be lean. It is not possible for an explosion to happen if a mixture is too lean.

Rich mixture

When the concentration of the combustible substance in the atmosphere is too high, the mixture is said to be rich. It is not possible for an explosion to happen if a mixture is too rich.

Explosive mixture

The range between a rich and a lean mixture is referred to as an explosive mixture. Within this range, ignition is possible with an ignition source.

Maximum and minimum explosion limit

The concentrations of the combustible substance at which an explosive mixture becomes either lean or rich are referred to as the lower and upper explosion limits.

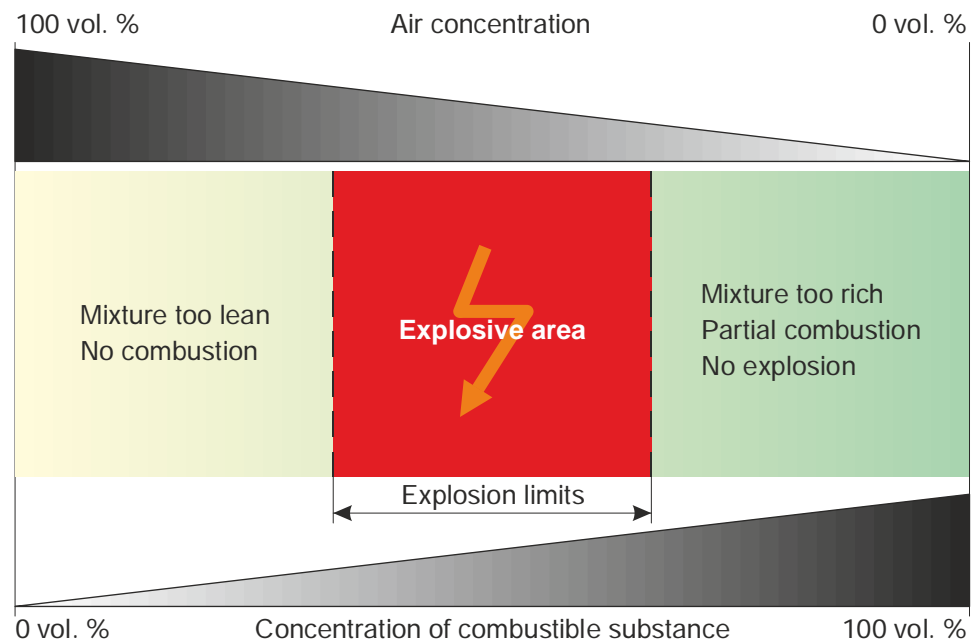

Explosion limits

3.4 Sources of ignition

Sources of ignition that could potentially occur in practice are:

- Mechanically generated sparks; e.g. as a result of using sparks generated from tools
- Hot surfaces
- Electrical sparks and arcs; e.g. as a result of
 - Short-circuit
 - Defects in the insulation on electrical lines
 - Electrostatic discharge on system parts
 - Lightning strike

3.5 Zone classification

Areas at risk of explosion are classified into danger zones to make it easier to select suitable equipment and design appropriate electrical installations.

You will find information and specifications for zone classification in standard EN 60079-10, as well as in various national regulations.

According to EN 60079-10, areas at risk of explosion are classified into three danger zones. The probability (by time and location) of a potentially explosive atmosphere occurring is key to this classification.



When classifying areas at risk of explosion into danger zones and specifying the required protective measures, it is always necessary to consider the highest possible potential for danger.

Zone 0:

Areas in which a potentially explosive atmosphere arises permanently or for long periods (e.g. the inside of containers, apparatus, pipelines, etc.).

Zone 1:

Areas in which a potentially explosive atmosphere can be expected to arise only occasionally (e.g. filling and emptying equipment, charging doors).

Zone 2:

Areas in which a potentially explosive atmosphere only arises rarely and, when it does, only for brief periods (e.g. areas surrounding zone 1).

Every industrial site must be individually classified into these zones. Note that the body responsible can classify one single at-risk area into various zones, e.g. the space up to a room height of 1.5 m as zone 1 and the section above this as zone 2.

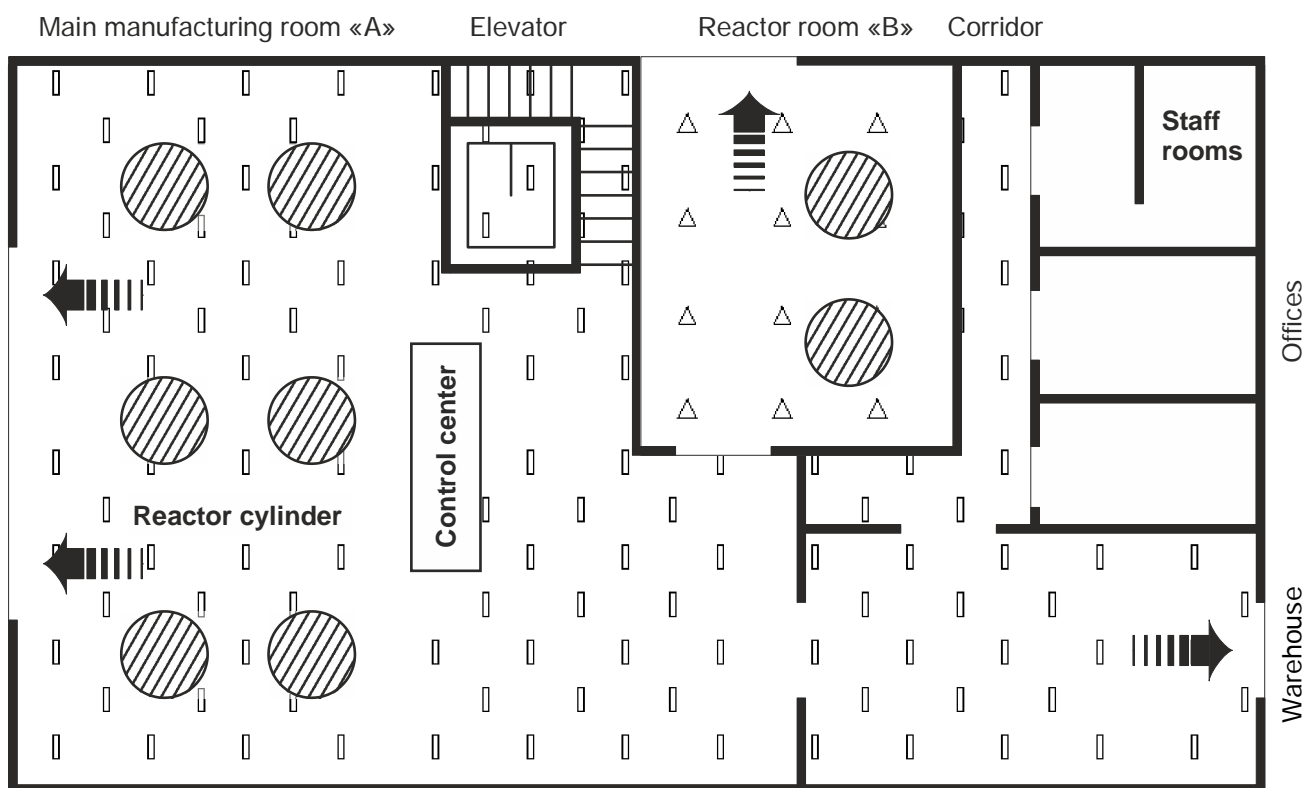

Example of zone classification:



A qualified person must carry out zone classification. If a company does not have an expert who is able to assess the risk of explosion and specify the required protective measures, the services of an expert body should be enlisted to do this.

3.6 Ignition protection category

Only explosion-protected equipment may be used in areas where a potentially explosive atmosphere could arise despite the use of measures to prevent such an occurrence.

Electrical equipment intended for use in explosive gas atmospheres can be designed in various ignition protection categories in accordance with EN 60079.

The manufacturer of the electrical equipment defines the ignition protection category depending on the equipment's type and function.

Some ignition protection categories are available in different safety levels. The safety levels correspond to the device categories laid down in Directive 94/9/EC.

Example for the 'intrinsic safety' ignition protection category with different safety levels:

Safety level:	Device category:	Can be installed in zone:
Ex ia	1	0 or 1 or 2
Ex ib	2	1 or 2
Ex ic	3	2



All standardized ignition protection categories within a device category should be viewed as equal.

Ignition protection category	Labeling	Schematic representation	Norm	Application
Pressure-resistant encapsulation	d		EN 60079-1	Switching stations, transformers
Overpressure encapsulation	p		EN 60079-2	Control cabinets, switching cabinets
Oil encapsulation	o		EN 60079-6	Switchgear, transformers
Sand encapsulation	q		EN 60079-5	Strip heaters, capacitors
Encapsulation	m		EN 60079-18	Sensors, switchgear
Increased safety	e		EN 60079-7	Terminals, terminal boxes

Ignition protection category	Labeling	Schematic representation	Norm	Application
Intrinsic safety	i		EN 60079-11	Actuators, sensors, fire detection installations
Ignition protection category "n_"	n	This ignition protection category comprises several different ignition protection categories	EN 60079-15	Programmable controllers

3.6.1 Ignition protection category 'Intrinsic safety'

The peripheral devices for fire detection installations, referred to in the chapters that follow, fall into the ignition protection category 'Intrinsic safety'. This means that we will only look at this particular ignition protection category in detail.

Intrinsic safety of a circuit is achieved by limiting current and voltage. This means that the ignition protection category 'Intrinsic safety' is limited to circuits with relatively low levels of power.

The ignition protection category 'Intrinsic safety' is based on the fact that a certain minimum ignition energy level is required to ignite a potentially explosive atmosphere. In an intrinsically safe circuit, no sparks or thermal heating that could lead to a potentially explosive atmosphere igniting will occur during operation or in the event of a fault.

Categories for intrinsically safe equipment

Intrinsically safe electrical equipment is divided into categories known as 'safety levels'. The applicable safety levels depend on the safety requirements that apply when the equipment is being designed.



The abbreviation 'EPL' ('Equipment Protection Level') is also used to refer to a safety level in many cases.

Safety level for intrinsically safe equipment	Description	Equipment installation
ia	When voltage U_m or U_i is applied, the intrinsically safe circuits must not lead to ignition in uninterrupted operation and in the presence of two countable faults plus their non-countable faults that give rise to unfavorable conditions.	All zones
ib	When voltage U_m or U_i is applied, the intrinsically safe circuits must not lead to ignition in uninterrupted operation and in the presence of one countable fault plus the non-countable faults that give rise to unfavorable conditions.	Zone 2, zone 1
ic	When voltage U_m or U_i is applied, the intrinsically safe circuits in the electrical equipment with safety level 'ic' must not be able to cause ignition during uninterrupted operation.	Zone 2

Differences between intrinsically safe equipment and associated electrical equipment

Intrinsically safe equipment	Associated electrical equipment	
Only contains intrinsically safe circuits	Contains intrinsically safe and non-intrinsically safe circuits	
Example: Ex ib IIC T6	Example: [Ex ib] IIC T6	Example: Ex de [ib] IIC T6
All necessary specifications such as category, explosion group, and temperature class are available.	Square brackets indicate that the associated electrical equipment contains an intrinsically safe electrical circuit that may be routed in zone 1, explosion groups IIA, IIB, and IIC.	
The equipment may be used in zone 1.	The equipment must be installed outside the area at risk of explosion.	The equipment may be used in zone 1 because it has been installed in a pressure-resistant housing.

3.7 Classifying electrical equipment

Areas at risk of explosion are classified into zones, while electrical equipment is classified into device groups and device categories.

On a certified device, information on the nameplate will tell you the zone in which the equipment may be used.

3.7.1 Classification into device groups

Electrical equipment for areas at risk of explosion is classified according to its usage conditions, as follows:

Device group I:

Electrical devices for mining, which may be put at risk by mine gas (methane/air mixture).

Device group II:

Electrical devices for operation in areas where a potentially explosive gas atmosphere is to be expected (except mines at risk of firedamp).

Device group III:

Electrical devices for operation in areas where a potentially explosive dust atmosphere is to be expected (except mines at risk of firedamp).

See also

 Product range [→ 29]

3.7.2 Classification into device categories

The device category determines which equipment may be used in which zone.

Device categories 1G, 2G, and 3G are defined for gas explosion protection.

- Equipment in device category 1G is suitable for zones 0, 1, and 2.
- Equipment in device category 2G is suitable for zones 1 and 2.
- Equipment in device category 3G is suitable for zone 2.

Equipment device category	Suitability for zones
1G	0 / 1 / 2
2G	1 / 2
3G	2

3.7.3 Explosion groups and temperature classes

For ignition protection categories 'd', 'i', 'nC', and 'nL', electrical equipment in group II is subdivided into groups IIA, IIB, and IIC in accordance with the applicable standards. The sub-division for pressure-resistant encapsulation is based on max. explosion-safe gaps (MESG).

For intrinsically safe electrical equipment, the sub-division for gases and steams is based on the ratios of their minimum ignition current (MIC) to the minimum ignition current of the lab methane.

Equipment that is ignition leakage-proof, e.g. with pressure-resistant encapsulation (ignition protection category 'd'), always features gaps. They occur mainly on housing parts, shafts and cable lead-throughs. A mixture capable of ignition can, therefore, enter a device's housing through these 'breathing' holes and can be ignited by sparks or electric arcs. Appropriate design of the gap on the housing can prevent the ignition leakage of an explosion flame.

Gases and steams have been classified into explosion groups and temperature classes on the basis of test results using the key values determined for them:

- Into explosion groups IIA, IIB, and IIC according to their ignition leakage capability through gaps, with equipment requirements ascending from IIA to IIC
- Into temperature classes T1 to T6 according to their ignition temperature

The table below shows some examples of how gases and vapors have been classified into explosion groups and temperature classes in accordance with standard EN 60079-0. This classification has allowed the design requirements of equipment with explosion protection to be graded accordingly. The temperature class requirements increase as the digits go up (1, 2, 3 etc.).

The customer must define the minimum requirements for the equipment based on their specific application. For example, temperature class T5 or T6 is only required in a very small number of cases.

	Temperature classes					
	T1	T2	T3	T4	T5	T6
Max. surface temperature of equipment [°C]	450	300	200	135	100	85
Explosion group						
I	Methane (firedamp)					
IIA	Ammonia, acetone, ethyl acetate, benzene, carbon monoxide, methanol, propane	butane	Hexane, benzene, heating oils, diesel fuels	Di-ethyl ether, acetaldehyde		
IIB	City gas	Ethylene	Hydrogen sulfide			
IIC	Hydrogen	Acetylene				Carbon disulfide

3.8 Labeling electrical equipment

General notices

In accordance with Directive 94/9/EC, Annex 2 (ATEX Directive), standard EN 60079-0, and the requirements of the certificates issued, each device must display at least the following details:

- Name of the manufacturer or his registered trademark
- The type designation of the manufacturer
- A serial number, except for
 - Connecting parts
 - Very small electrical devices, on which there is limited space
- Name or code of body issuing the certificate and the certificate number
- If particular conditions have to be pointed out for the application, the symbol 'X' must follow the certificate number.
- The relevant Ex labeling for potentially explosive gas or dust atmospheres
- All additional details listed according to the particular standards which apply to the ignition protection categories concerned.

Ex labeling for potentially explosive gas atmospheres

Ex labeling must include the following:

- The symbol 'Ex', which indicates that the electrical device corresponds to one or more ignition protection categories.
- The symbol for the ignition protection category used. For the ignition protection category 'intrinsic safety': 'ia', 'ib' or 'ic'
- The symbol for the explosion group: I, IIA, IIB or IIC
- For group II electrical devices, the symbol for the temperature class Group II electrical devices with a maximum surface temperature of over 450 °C only have to be labeled with the actual maximum surface temperature, e.g., 600 °C
- The applicable protection level, e.g., 'Ga', 'Gb', 'Gc', 'Ma' or 'Mb'

Associated electrical equipment

For associated electrical equipment, which is to be installed in hazardous areas and for which the energy limitation is within the device installed in the hazardous area, the symbols for the ignition protection category must be specified in square brackets, e.g., Ex d [ia] IIC T4 Gb.

If the device group of the associated electrical equipment differs from that of the device, the device group of the associated electrical equipment must be specified in square brackets, e.g., Ex d [ia IIC Ga] IIB T4 Gb.

Example of the labeling of electrical equipment

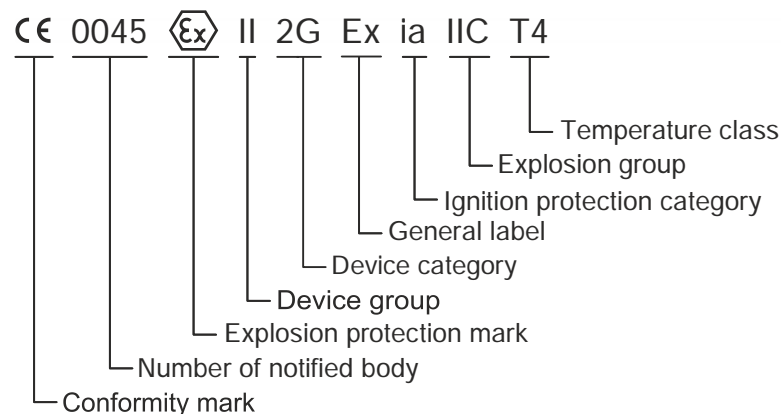

4 Use of fire detectors in areas at risk of explosion

Fire detectors are mainly used in zone 1 and 2 areas at risk of explosion.

Siemens' product range is designed for connection to intrinsically safe circuits, primarily category ia. This means that the devices can also be used in zone 0.

4.1 Intrinsically safe installation in accordance with EN 60079-14

Potentially explosive atmospheres generally only cover a small part of a system.

Control panels, terminals, and large parts of the system wiring can therefore be installed following the general valid rules, i.e., not intrinsically safe. They must be installed outside the potentially explosive atmosphere.

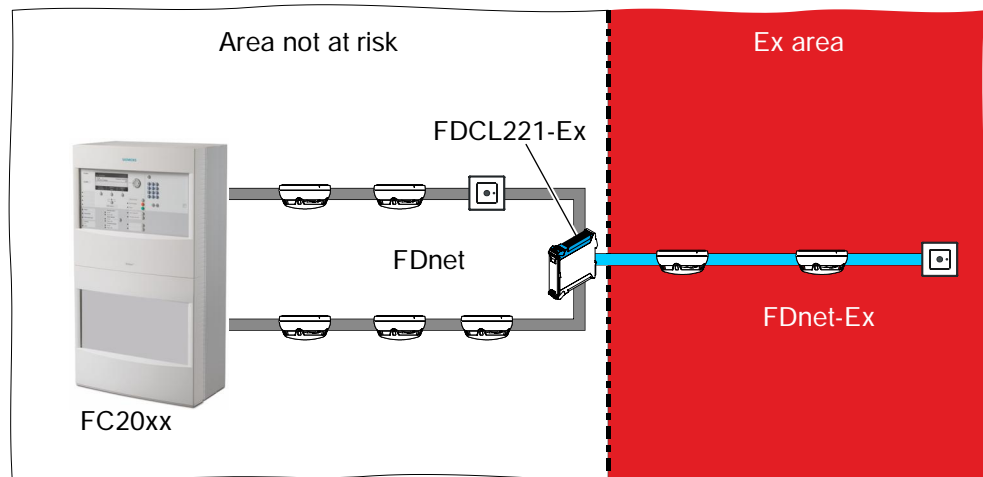

Example of installing a fire detection installation FS20 in an Ex area and a non-hazardous atmosphere

However inside the area at risk of explosion, the supply network plus all equipment must be designed to be intrinsically safe.

The physical division between non-intrinsically safe and intrinsically safe system components takes the form of line adapters (Ex) FDCL221-Ex, which limit the voltage, current, and power in the intrinsically safe circuit to safe values.

	⚠ WARNING
	<p>Overvoltage present at the line adapter (Ex) FDCL221-Ex in the event of an error Risk of explosion</p> <ul style="list-style-type: none"> • The line adapter (Ex) can only guarantee explosion protection up to the maximum voltage $U_m < 253$ V. Ensure that U_m is not exceeded. • Ensure that a maximum voltage $U_m < 253$ V is not exceeded on the detector line in the event of an error.

The line adapter (Ex) FDCL221-Ex can be used for categories 'ia', 'ib', and 'ic', thus supporting applications in zones 0, 1 or 2.

The line adapter (Ex) FDCL221-Ex has an isolated, intrinsically safe output circuit and so does not require a connection to equipotential bonding.

Grading the risk of explosion	Equipment labeling needed	
	Device group	Device category
Zone 0	II	1G
Zone 1	II	1G or 2G
Zone 2	II	1G or 2G or 3G



You will find information on intrinsically safe installations using safety barrier SB3 in document 001204. See the chapter 'Applicable documents [→ 7]'.

4.2 Product range

Below you will find a description of the approved periphery devices for fire detection installations FS20/FS720 in potentially explosive atmospheres.

Abbreviations used and their meanings:

Symbol	Meaning
C_i	Maximum internal capacity
C_o	Maximum external capacity
L_i	Maximum internal inductivity
L_o	Maximum external inductivity
I_o	Maximum output current
I_i	Maximum input current
P_o	Maximum output power
P_i	Maximum input power
U_i	Maximum input voltage
U_o	Maximum output voltage

You will find more information on the periphery devices in the assembly instructions and technical manuals for the individual devices. See the chapter 'Applicable documents [→ 7]'.

4.2.1 Operating conditions

The devices of the product range described below must only be used as intended.

You will find information on the intended use of every device in the chapter 'About this document' in the corresponding technical manual for the device.

See the chapter 'Applicable documents [→ 7]'.

4.2.2 Line adapter (Ex) FDCL221-Ex

Device	Approval number	Ex labeling		Detector line				
		Category	Ignition protection category $-25\text{ °C} < T_a < 60\text{ °C}$	C_0 [nF]	L_0 [mH]	U_0 [V]	I_0 [mA]	P_0 [mW]
FDCL221-Ex Line adapter (Ex)	BVS 12 ATEX E 094	II (1) G II (1) D	[Ex ia Ga] IIC [Ex ia Da] IIIC	82	2.9	28	92	644

	⚠ WARNING
	<p>Overvoltage present at the line adapter (Ex) FDCL221-Ex in the event of an error</p> <p>Risk of explosion</p> <ul style="list-style-type: none"> The line adapter (Ex) can only guarantee explosion protection up to the maximum voltage $U_m < 253\text{ V}$. Ensure that U_m is not exceeded. Ensure that a maximum voltage $U_m < 253\text{ V}$ is not exceeded on the detector line in the event of an error.

4.2.3 Point detector FDOOT241-A9-Ex

Device	Approval number	FDnet- Ex/C-NET- Ex MK	Ex designation	
			Category	Ignition protection category $-35\text{ °C} < T_a < 70\text{ °C}$
FDOOT241-A9-Ex Multi-sensor fire detector	BVS 12 ATEX E 087 X	1	II 1 G	Ex ia IIC T4 Ga

Ex-related connection data, intrinsically safe	U_i	28 V
	I_i	100 mA
	P_i	700 mW
	L_i	Negligible
	C_i	0,2 nF
Line to external alarm indicator	U_0	14.2 V
	I_0	480 mA
	P_0	195 mW
	L_0	100 μ H
	C_0	38 nF
Only for connecting passive, external alarm indicators with negligibly low inductance and capacitance levels.		

4.2.4 Point detector OOH740-A9-Ex

Device	Approval number	FDnet-Ex/C- NET-Ex MK	Ex designation	
			Category	Ignition protection category -35 °C < T _a < 70 °C
OOH740-A9-Ex Multi-sensor fire detector	BVS 12 ATEX E 087 X	1	II 1 G	Ex ia IIC T4 Ga

Ex-related connection data, intrinsically safe	U_i	28 V
	I_i	100 mA
	P_i	700 mW
	L_i	Negligible
	C_i	0,2 nF
Line to external alarm indicator	U_0	14.2 V
	I_0	480 mA
	P_0	195 mW
	L_0	100 µH
	C_0	38 nF
	Only for connecting passive, external alarm indicators with negligibly low inductance and capacitance levels.	

4.2.5 Manual call point FDM223-Ex

Device	Approval number	Ex designation	
		Category	Ignition protection category -35 °C < T _a < 70 °C
FDM223-Ex Manual call point	BVS 12 ATEX E 095 X	II 1 G II 1 D	Ex ia IIC T4 Ga Ex ia IIIB T135 °C Da

Ex-related connection data, intrinsically safe	U_i	28 V
	I_i	92 mA
	P_i	650 mW
	L_i	Negligible
	C_i	0,2 nF
Line to external alarm indicator	U_0	14.2 V
	I_0	480 mA
	P_0	195 mW
	L_0	100 µH
	C_0	38 nF
	Only for connecting passive, external alarm indicators with negligibly low inductance and capacitance levels.	

4.2.6 Simple electrical equipment

Equipment with simple and clear circuits (e.g. end-of-lines, LEDs, simple manual call points) is known as 'simple electrical equipment' or 'simple apparatus' in accordance with EN 60079-11, Section 5.7.

Simple electrical equipment does not have its own sources of ignition and is, therefore, not subject to Directive 94/9/EC, Article 1, Section 3.

The following are not required devices of this type:

- Certificate of conformity
- Assessment by a notified body
- Labeling

It is, however, necessary to ensure that simple electrical equipment does not represent a source of ignition (e.g. as a result of heating, sparking, or static discharge).

4.2.6.1 alarm indicators



Only connect passive, external alarm indicators with negligibly low inductance and capacitance levels.

Device	Order number	Ex designation	Comment
FDAI92-Ex Alarm indicator	S54370-F4-A1	Ex ib IIC T4 (-40 °C ≤ T _a ≤ 80 °C)	Connect an external alarm indicator to one detector only.
FDAI93-Ex Alarm indicator	S54370-F6-A1	Ex ib IIC T4 (-40 °C ≤ T _a ≤ 80 °C)	Only connect one external alarm indicator to each detector.

The alarm indicator contains an LED. The internal capacitance level C_i and the maximum internal inductance level L_i are negligible.

You will find more information about the external alarm indicators in document A6V10260486.

4.3 Specifications and restrictions relating to FDnet-Ex and C-NET-Ex

When planning a fire detection installation in a potentially explosive atmosphere, you must observe the system-specific points below in addition to the standards and directives already stated.



Only stubs are possible in FDnet-Ex/C-NET-Ex. Loops are not permitted.

Restriction on line length in the FDnet-Ex/C-NET-Ex

The maximum resistance of the line in the FDnet-Ex/C-NET-Ex is 50 Ω .

Load restriction

Maximum permissible FDnet-Ex/C-NET-Ex MK: 50



Further restrictions must be observed when installing the line adapter (Ex) FDCL221-Ex on long loops.

In such cases, use the 'FX2010 Sinteso Quantities Tool' (for 'Sinteso' fire detection installations) or the 'FX7210 Cerberus Quantities Tool' (for 'Cerberus PRO' fire detection installations).

Restriction on line length upstream of the line adapter (Ex) FDCL221-Ex

The maximum resistance of the line upstream of the line adapter (Ex) FDCL221-Ex is 200 Ω including the contributions made by isolating resistors of devices upstream of the line adapter.

Maximum number of line adapters (Ex) per loop

A maximum of two line adapters (Ex) FDCL221-Ex can be used on every loop.



Further restrictions must be observed when installing the line adapter (Ex) FDCL221-Ex on long loops.

In such cases, use the 'FX2010 Sinteso Quantities Tool' (for 'Sinteso' fire detection installations) or the 'FX7210 Cerberus Quantities Tool' (for 'Cerberus PRO' fire detection installations).

Adjacent arrangement of line adapters (Ex) on the detector line

If two line adapters (Ex) FDCL221-Ex are arranged one directly after the other on a detector line, a line separator FDCL221 must be installed between the line adapters (Ex).

You will find more information in document A6V10333771. See the chapter 'Applicable documents [→ 7]'.

5 Duties of the operator

To ensure safe operation of a fire detection installation in an area at risk of explosion, the operator must ensure that appropriate work equipment is available and that the personnel involved have the right skills and qualifications.

These measures are required in order to maintain the safety level guaranteed by the manufacturer in the as-delivered state of the devices throughout their entire service life.

To this end, the operator must put appropriate testing and maintenance measures in place, define suitable intervals for the measures to be carried out, and ensure that the work is carried out correctly.

The next chapters describe the duties of the operator with regard to these points.

5.1 Relevant legal regulations

It is only possible to ensure permanently safe operation of a fire detection installation in an area at risk of explosion if the following conditions are fulfilled:

- The manufacturer supplies a product with safety features that are in perfect working order.
- The operator ensures that the high standard guaranteed by the manufacturer is maintained at all times and that the product is used as intended.

Therefore, both the manufacturer and the operator have duties. These are governed by the legal regulations explained below.



The legal regulations referred to below (including, for example, directives and their implementations in national law) relate to the European Community area. The Ordinance on Industrial Safety and Health only relates to the Federal Republic of Germany.

5.1.1 Directive 94/9/EC

Directive 94/9/EC, also known as the 'ATEX Directive' is aimed at the manufacturers of devices, components, and protective systems in potentially explosive areas. Among other things, the Directive determines:

- Classification of the products into equipment groups and equipment categories
- The conformity assessment procedure for the individual equipment groups and equipment categories
- The responsibility of the manufacturer of a device, a component, or a protective system in relation to marking their products This responsibility covers both CE marking and marking with information which is relevant for explosion protection
- The minimum requirements for the contents of the instructions
- Fundamental health and safety requirements

5.1.2 Directive 2014/34/EU

Directive 2014/34/EU replaces Directive 94/9/EC on April 20 2016.



From April 20 2016, devices, components, and protective systems in potentially explosive areas may only be placed on the market in accordance with Directive 2014/34/EU.

Certificates in accordance with Directive 2014/34/EU will not be issued until April 20 2016.

Old certificates in accordance with Directive 94/9/EC will, however, continue to be valid.

5.1.3 Directive 99/92/EC

Directive 99/92/EC, also referred to as 'ATEX 137' specifies the operator's duties with regard to protecting personnel who work in areas at risk of explosion.

These duties cover, for example:

- An assessment of explosion risks by the operator
- Zone classification for areas with an atmosphere at risk of explosion
- Ensuring that the minimum stipulations are adhered to in the individual zones
- Creating and maintaining an explosion protection document containing the following, as a minimum:
 - Risk assessment information
 - Information on the protective measures in place
 - Information on zone classification
 - Information on adhering to minimum stipulations



Directive 99/92/EC only contains minimum stipulations. In the process of implementing the directive as national law, each state is free to define additional restrictions. For this reason, you must observe the relevant legal provisions of the state in which the fire detection installation is to be operated in an area at risk of explosion.

Directive 99/92/EC has been implemented as national law by the member states of the European Union. In Germany, for example, this takes the form of the Ordinance on Industrial Safety and Health (BetrSichV).

The legislation that is valid in each case must be applied as appropriate.

5.2 Technical regulations and standards

The standards listed in the table contain important information for the operator on the following subjects:

- Installation
- Inspection
- Repair
- Maintenance

Norm	Title
EN 60079-0	Explosive atmospheres – Part 0: Equipment – General requirements
EN 60079-10	Explosive atmospheres – Part 10-1: Classification of hazardous areas – Explosive gas atmospheres Part 10-2: Classification of hazardous areas – Explosive dust atmospheres
EN 60079-11	Explosive atmospheres – Part 11: Equipment protection by intrinsic safety "I"
EN 60079-14	Explosive atmospheres – Part 14: Electrical installations design, selection and erection
EN 60079-17	Explosive atmospheres – Part 17: Electrical installations inspection and maintenance
EN 60079-19	Explosive atmospheres – Part 19: Equipment repair, overhaul and reclamation
EN 60079-25	Explosive atmospheres – Part 25: Intrinsically safe electrical systems
EN 1127-1	Explosive atmospheres – Explosion prevention and protection – Part 1: Basic concepts and methodology

Overview of standards

5.3 Preparatory measures

The operator must carry out a risk assessment before installing equipment in an area at risk of explosion (in Germany, for example, this must be done in accordance with Section 3 of the Ordinance on Industrial Safety and Health).

In this context, zone classification has to be carried out.

The results of the risk assessment and zone classification procedures must be documented in the form of an explosion protection document.

The explosion protection document must contain the following information, as a minimum:

- Zone classification
- Temperature classes
- If no temperature classes are specified: information on the ignition temperatures that are characteristic for the combustible substances
- Classification of gases into temperature classes

Additionally, it is the operator's responsibility to check whether the equipment intended for installation is suitable for its intended use in an area at risk of explosion. The data required to check this can be found on the nameplate of the equipment and in the operating instructions.

Following this, the operator must check whether the intended equipment can be interconnected when line lengths are taken into account.

For this purpose, the actual system topology must be known, including the values U_i , I_i , U_o , and I_o .

The cable lengths and cable parameters must be known as well.

The annex to this document contains an example of performing an assessment calculation for intrinsic safety.

See also

 Annex A - Sample calculation [→ 56]

5.4 Installation information

When mounting and installing equipment, it must be ensured that said equipment can be easily accessed for inspection and maintenance purposes.

Electrical equipment must be safeguarded against external influences, which could have a negative impact on explosion protection. Possible influences are:

- Chemical actions, e.g., acid or alkali
- Thermal actions, e.g., hot surfaces on adjacent equipment
- Mechanical actions
- Vibrations that occur
- Moisture

Observe the following points when mounting and installing equipment in potentially explosive atmospheres:

1. Avoid contact with bright live parts. Such contact could result in an ignition spark being generated.
2. Lay all cables and lines such that they are protected against the external influences already stated.
 - Consider laying lines in conduits.
 - Use strain relief devices.
 - Fix lines by mechanical means outside of housings too.
3. The cable entries used must correspond to the ignition protection category of the relevant housing.
4. Suitable end plugs must be used to safely seal openings in housings which are not required.
5. Only leave the housing of explosion-protected electrical equipment open for as long as is necessary for mounting and installation purposes. Close the housing as soon as the work is complete to prevent dirt and moisture from accumulating inside it.
6. When inserting the connecting line through the cable entry, ensure that the outer diameter of the cable fits the clamping range of the cable entry. Select the inner diameter of the cable entries such that the cables fill their cross section. Then securely tighten the union nuts of the cable entry.
7. When using cable entries which enter a housing from above, ensure that no moisture can get into the housing from the inside of the cable. Create a cable loop, for example, upstream of where the cable enters the housing.
8. Use terminal and line cross sections which match one another. The clamping capacity of the connection terminals must fit the cable cross section.
9. After connecting the lines to the terminals, check whether the clearances and creepage distances specified for the corresponding ignition protection category have been complied with.
10. Protect the ends of the lines from separating, e.g., using accessories such as wire end ferrules or cable lugs. Only use the accessory recommended for the corresponding cable cross section and the tools recommended by the manufacturer of that accessory.
11. Strip the wires to the length specified by the manufacturer. Stripping too much or too little can have a negative impact on explosion protection.
12. Avoid creating impermissible bundles of live conductors in housings; you will thus prevent excessive heat being generated in said housings.
13. Lay control circuits so they are isolated from main circuits; you will thus prevent interactions.

Intrinsic safety 'i' ignition protection category

Ensure that the intrinsically safe circuits are isolated from non-intrinsically safe circuits, as well as from other intrinsically safe circuits:

1. Always lay intrinsically safe circuits and non-intrinsically safe circuits so they are isolated from one another. Observe the minimum distances of the lines.
2. Identify intrinsically safe circuits consistently, e.g., by using light blue lines.
3. Observe the requirements for grounding and shielding intrinsically safe circuits.
4. If equipment is interconnected with intrinsically safe circuits: Ensure that the intrinsic safety remains intact.

The following points must be noted when the mounting and installation work is complete:

1. Check the condition of the terminal compartment before closing the housings. Look out for moisture and dirt. If necessary, clean and dry the terminal compartment.
2. Check all mechanical and electrical connections.
3. Close the housing in accordance with the information provided by the manufacturer. Observe any information on tightening torques for screws.
4. Install the spacer, disconnecting, and shock-hazard protective devices which were removed back into the correct positions.

5.5 Technical documentation for testing and maintenance work

The technical documentation required for testing fire detection installations in areas at risk of explosion can be divided into two groups:

- Generally applicable documentation
- Product-specific documentation

Generally applicable documentation

Generally applicable documentation includes the following documents, for example:

- Relevant standards and regulations for the ignition protection categories concerned
- All standards relating to the following work on electrical systems in areas at risk of explosion:
 - Test
 - Maintenance
 - Modifications
- All relevant legal regulations, such as the German Ordinance on Industrial Safety and Health and the corresponding technical rules for operating safety (TRBS)

Product-specific documentation

Product-specific documentation includes, for example:

- Operating instructions for the equipment being used
- EC-type examination certificates
- Declarations of conformity for the equipment being used
- Circuit diagrams, terminal diagrams, etc., if applicable
- Information on the equipment nameplates



Keep the technical documentation in a safe place. If all or part of the technical documentation is lost, make sure to replace the missing parts immediately. It is only possible to carry out reliable testing and maintenance work if all the documents are available.

5.6 Qualifications of the testing personnel

All specified tests must be carried out by qualified people or an approved monitoring body.

5.7 Tests prior to first commissioning

Before commissioning is performed for the first time, the operator must observe the following points:

- Before commissioning is performed for the first time, make sure that work equipment whose safety is reliant on the installation conditions is tested after installation and before commissioning for the first time, as well as each time it is installed at a new site or location.
- Have tests carried out on work equipment that may be subject to damaging influences:
 - The operator must determine the test intervals
 - Tests must be performed by qualified persons
 - In the event of unusual occurrences that could impair the safety of the work equipment, have a test carried out by qualified persons immediately
- After troubleshooting work, have the work equipment tested by qualified persons to ensure it can be operated safely
- Make sure the tests are also satisfactory for the results of the risk assessment (in accordance with national law)

An independent expert who is a 'qualified person of type C' must perform testing and approval of a complete system in accordance with Directive 99/92/EC prior to commissioning for the first time.

The following must be tested:

- Workstations
- Work equipment provided at workstations
- Working environment
- Measures for protecting third parties

Workstations in areas at risk of explosion

Before workstations in areas at risk of explosion are used for the first time, the operator must also check the explosion safety of the workstations, the work equipment provided for them, the working environment, and the measures for protecting third parties.

Detailed tests on devices

Before a system that requires monitoring is commissioned, either for the first time or after a significant modification has been made to it, it is necessary to check that it has been installed correctly, that the installation conditions are correct, and that it is able to function safely. This must be carried out by an approved inspection body, with the system's intended mode of operation taken into account.



In some countries, the detailed test also has to be performed by a qualified person. Please refer to your national legislation.

The detailed test involves checking the rules outlined in section 'Installation information [→ 37]' plus all the measurements and function tests required to determine whether a device is safe.

Additionally, the detailed test must look at the following:

- Protective systems set to the required rated current I_r
- Whether all the grounding and equipotential bonding connections are complete, and whether the conductor resistance is below the required maximum value

5.8 Recurring tests

At regular intervals, an approved inspection body must perform recurring tests on systems that require monitoring and their system components. The tests aim to determine whether the system is operating correctly.

It is the operator's responsibility to determine the test intervals for the entire system and the system components, on the basis of a safety evaluation.

In the case of systems in areas at risk of explosion, tests must be performed every three years as a minimum.

This means that the test intervals may also be much shorter than 3 years. The following must be taken into account when determining test intervals:

- The manufacturer's information about the equipment
- Ambient conditions, e.g. the presence of corrosive atmospheres, dirt, etc.
- Operating conditions, e.g. strain on the equipment, duty cycles, etc.
- The operator's experience with similar or identical equipment, with ambient conditions and operating conditions taken into account
- Changes to the zone classification in the system or a change to the installation location of a piece of equipment; these may cause the test intervals to change

Types of tests/checks

In addition to the technical test (in other words, a direct test performed on the system or system components), it is also necessary to perform a documentation and organization check.

The documentation and organization check involves determining whether the documents required for testing are present and complete. These documents include:

- The explosion protection document or an extract from the explosion protection document that is relevant to the system component being tested
- The operating instructions for the equipment being used
- Circuit diagrams and installation diagrams
- EC declarations of conformity and certificates of conformity
- Exemption certificates
- Installer certificates
- Test certificates

The selection of documents to be checked is at the discretion of the person carrying out the check. A table of contents showing which documents are available is a mandatory requirement.

5.9 Repair

If an item of equipment in a potentially explosive atmosphere has a defect which could endanger employees or third parties, it must not be operated any further.

The operator has the following obligations regarding systems which require monitoring:

- The systems must be maintained in a proper condition.
- The systems must be monitored. Required troubleshooting or maintenance work must be carried out at once. The safety measures necessary for the circumstances in question must be put in place.

If the troubleshooting work concerns the safety of the equipment, said equipment must be checked by a qualified person prior to it being put back into operation.

Specific statements are laid down in the national regulations designed to implement Directive 94/9/EC.

For the Federal Republic of Germany, for example, the following statement can be found in Section 14, Paragraph 6 of the Betriebssicherheitsverordnung:

'If a device, a protective system or a safety, inspection or control device in the sense of Directive 94/9/EC relating to a part on which explosion protection depends has been repaired, it (...) may only be put back into operation once the approved monitoring body has established that its features which are fundamental to explosion protection meet the requirements of this investigation (...). The checks according to Clause 1 may be carried out by qualified people within a company, provided that these people are recognized by the authority responsible for checking the devices, protective systems or safety, inspection or control devices repaired by this company.'

5.10 Special requirements for ignition protection category 'Intrinsic safety'

The principle of 'intrinsic safety' is based on safely limiting electrical energy in a circuit to values that are below the minimum ignition energy of a potentially explosive atmosphere. This also involves limiting the heating in the circuit to a safe level.

'Intrinsic safety' is achieved using the following measures:

- Limiting current values
- Limiting voltage values
- Limiting possibilities for energy to be stored in capacitors and inductors



The ignition protection category 'Intrinsic safety' means more than just looking at the equipment in and of itself. Instead, the entire circuit has to be taken into account.

1. Regularly check the logical links between the system zone classification, the documentation for the intrinsically safe circuits, and the intrinsically safe equipment that is installed. All the components must be compatible and work in harmony with one another.
2. Separate intrinsically safe and non-intrinsically safe circuits from one another.
 - Maintain the minimum clearances between intrinsically safe and non-intrinsically safe circuits. Regularly check whether these minimum clearances are being adhered to.
 - Regularly check the insulation for neighboring intrinsically safe and non-intrinsically safe lines. Replace damaged lines.
 - Make sure that sufficient insulation is being used. Regularly check for damaged insulation.
3. Use clear methods of identifying intrinsically safe circuits, such as the following:
 - Use bright blue lines for intrinsically safe circuits.
 - Use bright blue gland screw connections for intrinsically safe circuits.
 - Install information signs that indicate intrinsically safe circuits.



When using information signs, make sure the information on them is always legible. Regularly check the condition of the information signs. Replace information signs that are no longer easily legible.

4. Regularly check whether impermissible and non-documented changes, which could impair intrinsic safety, have been made to intrinsically safe circuits.
5. Regularly check whether energy-limiting equipment, such as separation devices, fieldbus components, and safety barriers, conforms to the certified type and has been installed in compliance with the specifications of the inspection body and the manufacturer.
6. Regularly check whether the required grounding mechanisms are present on all components, and whether insulation resistances to ground are present.
 - For testing purposes, only use testing devices that are specifically designed for insulation testing on intrinsically safe circuits.



⚠ WARNING

Combining different ignition protection categories

Risk of explosion

- Observe the applicable installer's regulations.
- Check whether the intended combination of ignition protection categories is permissible.

5.11 Maintenance

As well as recurring tests, there are additional tasks that the operator has to carry out at regular intervals. These include, for example, cleaning work in the area at risk of explosion.

There are also various testing measures, which are described in the next sections.

Insulation resistance and contact resistance measurements

The measuring devices for insulation resistance and contact resistance measurements do not usually comply with the requirements of the ignition protection category 'Intrinsic safety'. This means that these measuring devices must not be used in atmospheres where there is a risk of explosion.

The personnel who carry out these measurements require an appropriate permit.

Generally, electrical equipment must not be opened in potentially explosive atmospheres.

Measuring loop resistance in TN networks

Regularly measuring loop resistance ensures that protective measures against lightning strikes remain effective.

Testing the equipotential bonding

It is only necessary to test the equipotential bonding (by taking measurements) in cases where there is no other way to assess whether the connection work has been carried out correctly.

These measurements require an insulation measuring device with a measuring voltage equivalent to the mains voltage or DC 500 V. Do not use basic continuity testers: These can simulate high levels of contact resistance and thus produce inaccurate measurement results.

Testing the function of monitoring devices

Regularly check monitoring devices such as residual current-operated circuit breakers and temperature limiters to ensure they are functioning correctly.

Service life of equipment

If the manufacturer has specified a maximum service life for individual pieces of equipment (age, number of operating cycles, etc.), then the equipment must be replaced in good time before this is reached. Regularly check whether the equipment needs to be replaced.

6 Mounting/Installation

General planning specifications for fire detection installations also apply to areas at risk of explosion. Therefore, you must also observe the planning documentation for your fire detection installation.

This document only deals with special considerations that apply when a fire detection installation is being installed in areas at risk of explosion.



In all cases, the process of installing fire detection installations in areas at risk of explosion should be based on country-specific regulations. For this reason, you should make yourself familiar with the applicable regulations, directives, and standards before planning or installing a fire detection installation in an area at risk of explosion.

When used in atmospheres at risk of gas explosion:

The manual call point FDOOT241-A9-Ex must be protected against electrostatic charging, along with all its accessory parts.

6.1 Preparatory measures

Zone plan

- A zone plan should be requested from the bodies responsible. The zone plan must clearly specify zones 0, 1, and 2 as well as areas that are not at risk of explosion.
- Ask the bodies responsible for specifications about the relevant solvent or gas and the T1...T6 temperature class assigned to it, plus the explosion groups (IIA, IIB, or IIC).

These specifications are required when ordering the necessary devices and installation materials.

See also

 Zone classification [→ 20]

6.2 Installation guidelines

- Cables may only be laid in rooms at risk of explosion if they are used in the systems located in these rooms.
- Recess-mounted cables which are fully laid in concrete may be guided through the Ex area.
- Only apparatus conforming to the specifications in chapter Product range [→ 29] may be used downstream of the line adapter (Ex).
- If an external alarm indicator is installed outside the Ex area, energy limitation is usually also required. In some countries (e.g. Switzerland), energy limitation is not needed if the alarm indicator is installed directly on the wall to the room at risk of explosion. A typical example of energy limitation is using an appropriate fail-safe transmitter (such as a line adapter (Ex) or a diode safety barrier).
- Lead-throughs between rooms at risk of explosion and rooms not at risk of explosion must be gas-tight. This applies to both the detector line and the lines for connecting external alarm indicators.
- Cables and pipes must be clearly labeled in accordance with the specification for intrinsically safe installations at points where the direction changes and where they enter the apparatus. Recommendation: Use the color bright blue. Bright blue glue points or bright blue insulating tape can also be used.

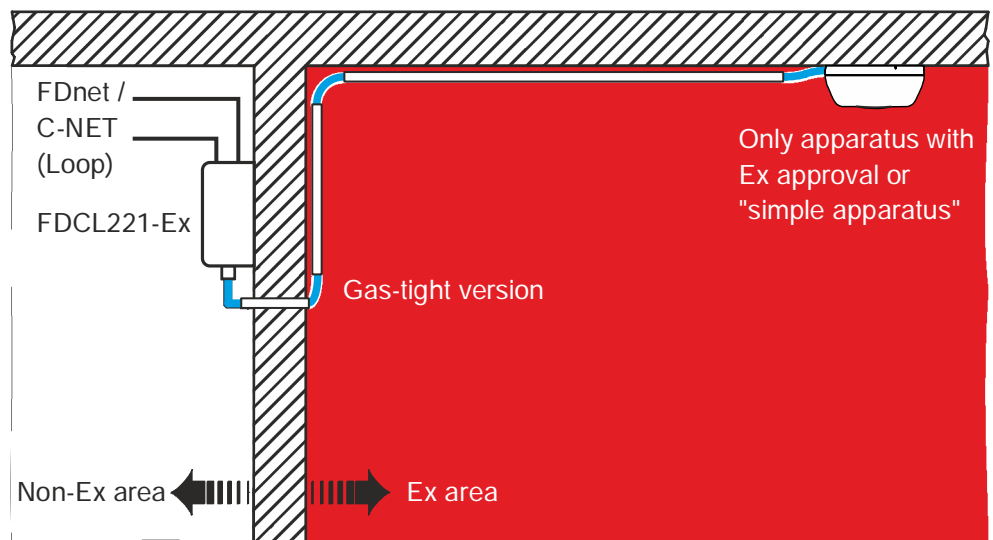

Example of installation in an area at risk of explosion

6.3 Installation materials for zones 0, 1, and 2

- Only installation materials which correspond to the national directives may be used in rooms at risk of explosion.
- We recommend plastic pipes labeled as 'flame retardant' for installing fire detection installations.
- If metal pipes are laid, these should be connected to the equipotential bonding.
- Country-specific, standard cables and installation materials can usually be used.

Device	Design
Pipes:	<ul style="list-style-type: none"> ● PVC basis, flame retardant ● Metal pipes
Cable:	<ul style="list-style-type: none"> ● Standard cable with solid conductor, $\varnothing \geq 0.6$ mm ● Shielded cable with solid conductor, $\varnothing \geq 0.6$ mm
Devices:	<ul style="list-style-type: none"> ● In a potentially explosive atmosphere upstream of the line adapter (Ex): Standard version ● Downstream of the line adapter (Ex) in a potentially explosive atmosphere, only devices which have been approved for potentially explosive atmospheres
Line adapters (Ex):	FDCL221-Ex line adapter (Ex)

See also

 Line adapter (Ex) FDCL221-Ex [→ 30]

6.4 Protective clearances for door and ventilation openings

The national specifications determine the size of protective spacing for electrical apparatus at door and ventilation openings in rooms at risk of explosion.

If no relevant specifications exist, we recommend:

- Devices which are installed in a non-hazardous atmosphere must be at least 1 m away on all sides from door openings and other openings to rooms at risk of explosion.
- You must only install Ex-approved devices within the protective spacing area.
- The protective spacing must be entered on the zone plan.
- The line adapter (Ex) must always be installed in the non-hazardous atmosphere, taking the protective spacing into account.

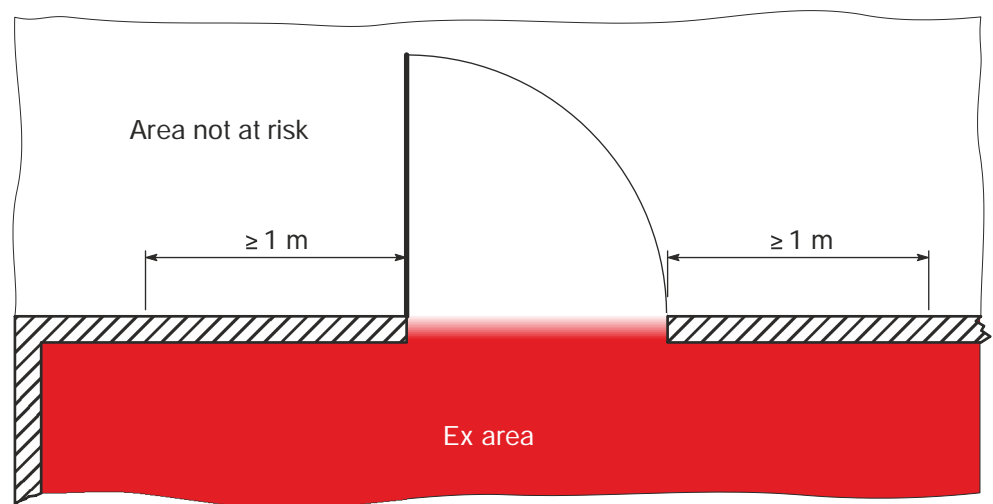

Protective spacing at door and ventilation openings

6.5 Equipotential bonding

In areas at risk of explosion, systems and system parts made from metal must be connected to the equipotential bonding.

Whether an appropriate equipotential bonding is present must be established before the start of installation.

If there is no equipotential bonding, the project manager responsible must ask the site owner to rectify this deficiency. The equipotential bonding should be grounded following national guidelines.

The equipotential bonding is an interconnection of the following elements:

- Local water pipe
- Foundation grounding
- Lightning protection system
- Water pipe
- Ventilation pipes
- Heating pipes
- Installation pipes made from metal
- Larger masses of metal, such as containers and racks
- The ground conductor for grounding

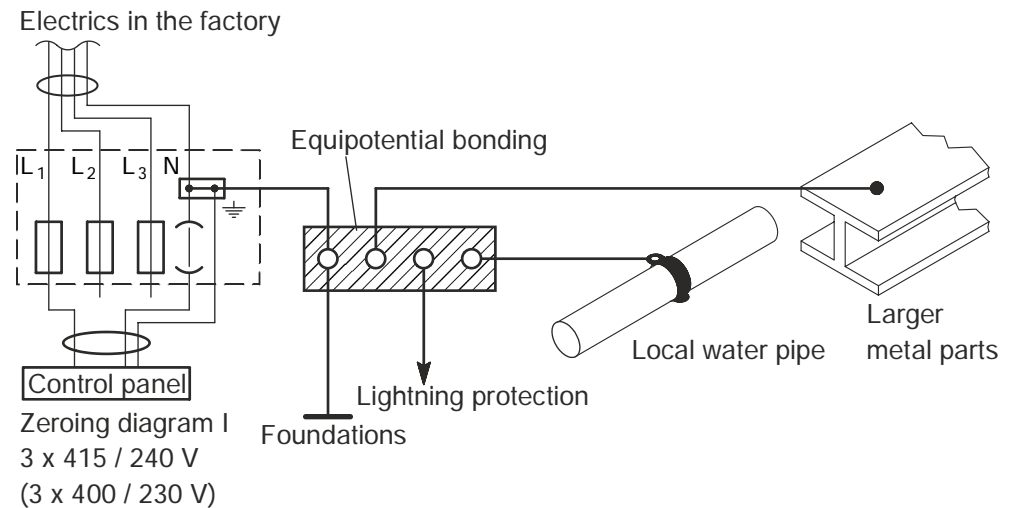

Example of equipotential bonding grounding

The cross-section for the equipotential bonding must conform to national guidelines.

The pipe connection parts (sleeves, for example) for water pipes, pipes for sprinkler systems, and dry extinguishing systems must be screwed down with tools in a way that ensures full, metal contact between the threads.

Pipe screw connections in which at least 5 thread turns are made satisfy these requirements provided that the conductivity is not restricted by seal material made of hemp or Teflon, for example.

6.6 Intrinsically safe circuits with line adapter (Ex) FDCL221-Ex

To prevent undesirable ground currents, the line adapter (Ex) FDCL221-Ex is implemented as a genuine transmitter that provides electrical isolation.

- As far as possible, line adapters (Ex) must be positioned directly in front of the room at risk of explosion.
- If line adapters (Ex) have to be installed further away, the cables downstream of the line adapter (Ex) must be labeled as specific for that country.

	<p>⚠ WARNING</p>
	<p>High line and device capacitance downstream of the line adapter (Ex)</p> <p>Risk of explosion</p> <ul style="list-style-type: none"> • The capacitance of the detector line plus all devices may not exceed 82 nF downstream of the line adapter (Ex). • The inductance of the detector line plus all devices may not exceed 2.9 mH downstream of the line adapter (Ex).

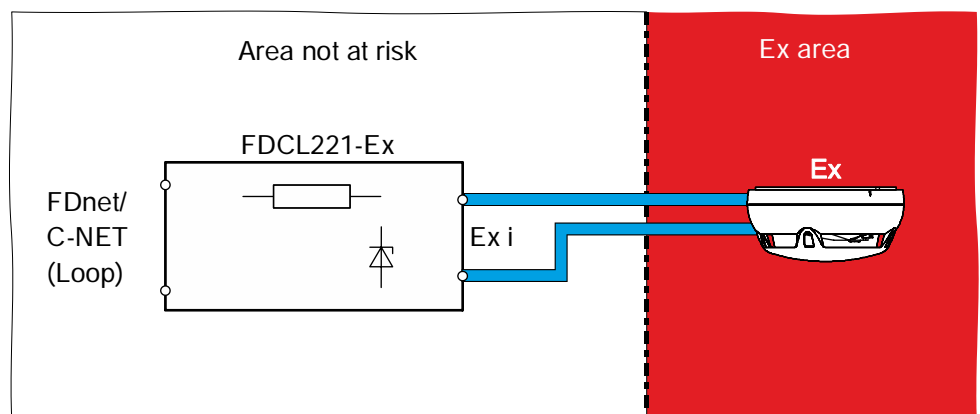

Intrinsically safe circuit with line adapter (Ex) FDCL221-Ex



The line adapter (Ex) FDCL221-Ex does not require grounding.

Information on line routing

- In accordance with EN 60079-14, installation downstream of line adapters (Ex) FDCL221-Ex must be carried out using a line that is identified as intrinsically safe. Recommendation: Use the color bright blue to identify the line.
- Intrinsically safe lines must be routed separately from non-intrinsically safe lines.
- The circuits in the intrinsically safe line must not be connected to one another.
- Only intrinsically safe circuits may be routed in the distribution boxes.
- The connection parts in the distribution boxes must be at least 6 mm apart from one another and identified as intrinsically safe in accordance with EN 60079-11.

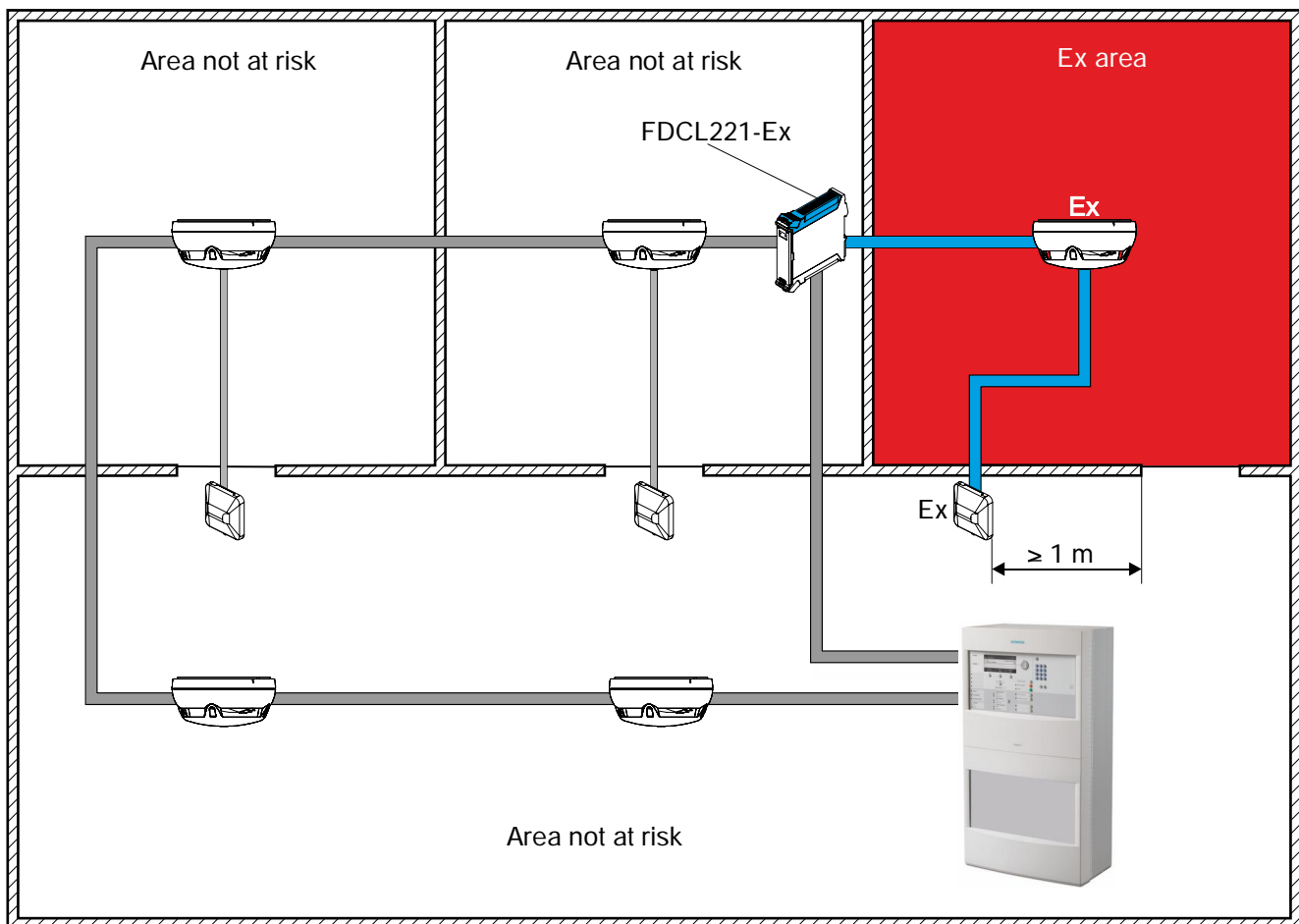

Example of a fire detection installation in an area at risk of explosion



Fire detector



Alarm indicator



Ex fire detector



Line adapter (Ex)

6.7 External alarm indicators FDAI92-Ex and FDAI93-Ex

- External alarm indicators are normally fitted outside the potentially explosive room without line adapters (Ex) directly on the wall to the potentially explosive room. An energy limitation device must be installed for larger distances between the alarm indicator and the potentially explosive room or if differing guidelines apply in that country. The external alarm indicators may also be installed inside the potentially explosive room.
- There may only ever be one detector connected to an external alarm indicator. You will find more information about the external alarm indicators in document A6V10260486.

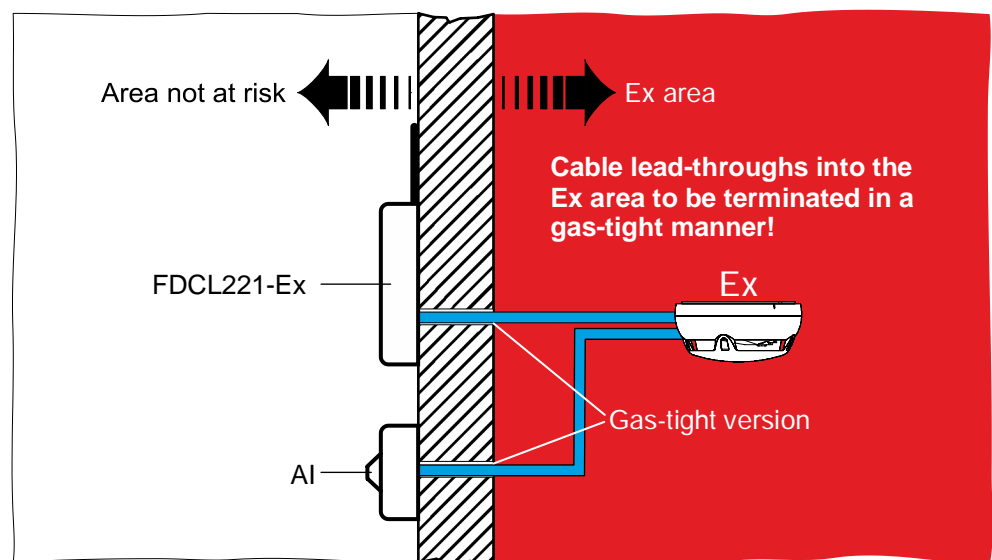

Schematic diagram of the usual arrangement of an external alarm indicator

6.8 Grounding (fire detection and control lines)

- When using shielded cables, the shieldings must be linked from one detector to the next.
- Shieldings may only be grounded at one side of the equipotential bonding.
- Fire detectors with metal housings require an external connection for the equipotential bonding.
- The equipotential bonding rail must be in the area at risk of explosion in all cases.

7 Commissioning

The devices are commissioned via the control panel. The exact procedure is described in the control panel documentation.

Conduct a performance check once commissioning is complete.



⚠ WARNING

Using measuring and testing devices in potentially explosive areas

Risk of explosion

- In potentially explosive areas, only use measuring and testing devices that are expressly approved for use in potentially explosive areas.

Atmospheric conditions

In zone 0, potentially explosive vapor/air mixtures may only arise under atmospheric conditions.

If there are no potentially explosive mixtures or additional measures have been put in place in line with EN 1127-1, the devices may also be operated outside the atmospheric conditions, as specified by the manufacturer.

8 Maintenance/Serviceing

	<p>⚠ WARNING</p>
	<p>Using measuring and testing devices in potentially explosive areas Risk of explosion</p> <ul style="list-style-type: none"> • In potentially explosive areas, only use measuring and testing devices that are expressly approved for use in potentially explosive areas.

	<p>⚠ WARNING</p>
	<p>Improper cleaning and maintenance of devices Risk of explosion</p> <ul style="list-style-type: none"> • Avoid electrostatic charging of devices during maintenance and cleaning work. • Do not use any solvents!



8.1 Responsibilities and choosing personnel

The operator is responsible for ensuring that systems in areas at risk of explosion are operated correctly.

Correct operation also covers maintenance and servicing work.

The operator must ensure that appropriate personnel are assigned to the work and that they are able to recognize how explosion protection may relate to their activities.

9 Annex A - Sample calculation

	 WARNING
	<p>Risk of explosion Incorrect evaluation or calculation of a simple intrinsically safe system</p> <ul style="list-style-type: none"> • The observations and calculations below may only be used if the system in question uses one current source alone.



You will find more information about intrinsically safe systems in EN 60079-25.

9.1 Sample calculation

To check whether your intended system can be considered to be intrinsically safe, proceed as follows:

- Determine the characteristics for the electrical equipment (see 'Product range [→ 29]').
- Determine the characteristics for the lines. You will find the relevant information on the data sheet for the line. You can request the data sheet from the manufacturer.
- Check whether the electrical equipment in question may be used in your intended environment in the first place.
 - Check the device groups (see 'Classification into device groups [→ 24]').
 - Check whether the electrical equipment may be used in the intended zone (see 'Classification into device categories [→ 25]').
- Calculate how many detectors may be used and the maximum permissible length of the lines.
- Compare the calculation results with your plans and check whether the former fall within the scope of the device data.
- Document your calculations and keep the document somewhere safe.



The planning tools corresponding to your fire detection system must be used for the permissible system configuration, particularly when considering devices with high current consumption.

Note that in potentially explosive atmospheres the permissible number of devices often exceeds the driver capacity of the line adapter (Ex) which is permissible from an explosion protection point of view.

The procedure described above is presented below in terms of a concrete example.

Initial situation

You are planning a 'Sinteso' fire detection installation in a potentially explosive atmosphere.

The potentially explosive atmosphere has been classified as 'zone 1', category '2G'. Gasoline vapor may be produced in this atmosphere.

The fire detection installation should contain the following electrical equipment in the potentially explosive atmosphere:

- 1x line adapter (Ex) FDCL221-Ex
- 3x point detectors FDOOT241-A9-Ex
- 1x manual call point FDM223-Ex
- 2x alarm indicators FDAI92-Ex

The graphic below shows a schematic representation of the installation situation with cable sections a...f:

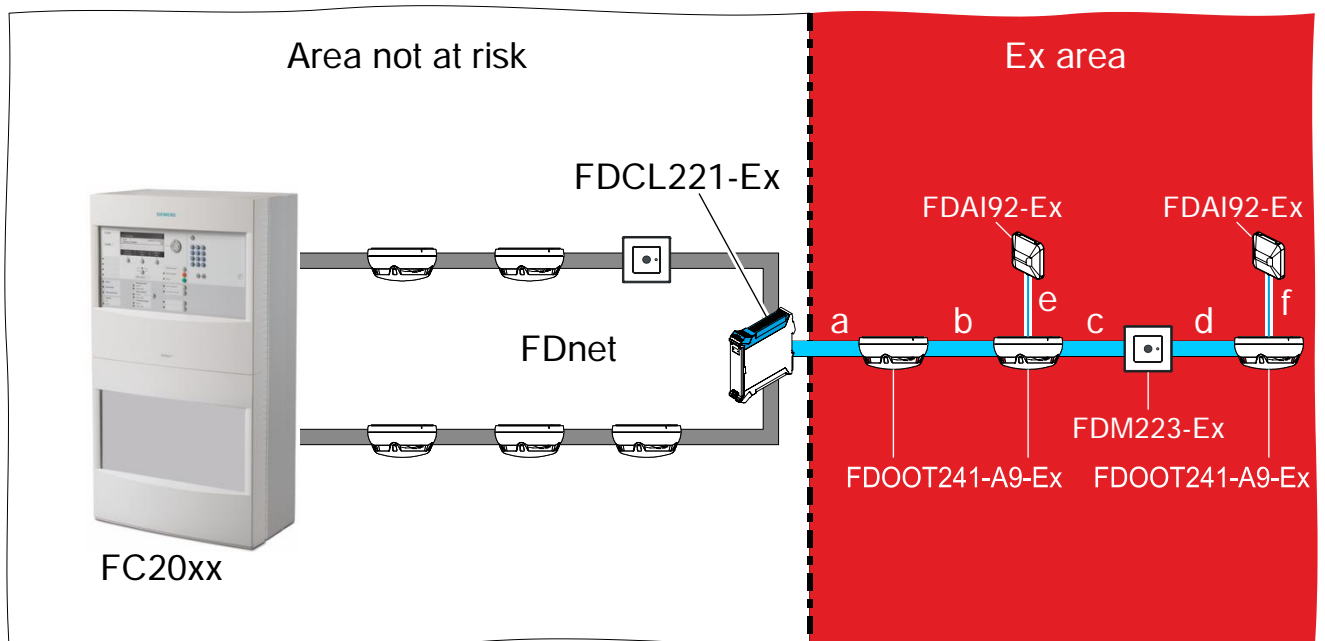

Example of a 'Sinteso' fire detection installation being planned in a potentially explosive atmosphere



The example above shows an installation of manual call points and automatic point detectors on the same stub. This arrangement is not permitted in all countries.

Therefore, observe the general country-specific regulations for installing fire detection installations.

Characteristics of the electrical equipment

FDCL221-Ex characteristics	
Voltage U_0 [V]	28
Current I_0 [mA]	92
Power P_0 [mW]	644
Output characteristic	Linear
C_0 [nF]	82
L_0 [mH]	2.9

Value	Equipment	
	FDOOT241-A9-Ex	FDM223-Ex
C_i [nF]	0,2	0,2
L_i [mH]	Negligible => 0	Negligible => 0
C_0 [nF]	38	38
L_0 [μ H]	100	100

Cable used

A two-wire, twisted cable should be used for the detector line in the potentially explosive atmosphere. The manufacturer specifies the following data for the cable:

C_c	100 nF/km
L_c	0.5 mH/km
R_c	130 Ω /km

An existing cable whose characteristics are unknown is used to connect the external alarm indicator FDAI92-Ex. In this case, characteristics in line with EN 60079-14, chapter 12.2.2.2, case C are employed in the calculation example:

C_c	200 pF/m = 200 nF/km
L_c	1 μ H/m = 1 mH/km or 30 μ H/ Ω

The cable lengths in the potentially explosive atmosphere are as follows:

Section	a	b	c	d	e	f
Length	120 m =0.12 km	50 m =0.05 km	40 m =0.04 km	30 m =0.03 km	20 m =0.02 km	25 m =0.025 km

Checking the devices used

The first step is to check whether the devices are suitable for the class of atmosphere. Since all 'Sinteso'/'Cerberus PRO'-Ex devices have been approved for class 2G, this condition is met.

A comparison of the gases being emitted, in this case gasoline, with the approved explosion group and temperature class of the devices (IIC T4) shows that this condition is met too.

The devices are suitable for the intended use.

Checking the cables used

The cables must satisfy the following standards:

- EN 60079-14
- EN 60079-25

Note any applicable national requirements.

Calculation



Standards EN 60079-14 and EN 60079-25 specify regulations which must be observed as an essential requirement.

The line adapter (Ex) FDCL221-Ex is assumed to be the only current source for the potentially explosive atmosphere. A linear current-voltage characteristic is viewed as the worst-case operating scenario.



Annex A of EN 60079-25 provides assistance in considering the application case.

Checking the conditions for the intrinsic safety of the detector line

Condition (1): The output parameters of the line adapter (Ex) must be lower than the input parameters of the equipment.

Therefore, the following applies:

$$U_0 \leq U_i$$

$$I_0 \leq I_i$$

$$P_0 \leq P_i$$

This prerequisite is fulfilled thanks to the system design of the 'Sinteso'/'Cerberus PRO'-Ex line adapter (Ex) and the 'Sinteso'/'Cerberus PRO'-Ex detector.

Condition (2):

$$C_0 \text{ (line adapter (Ex))} > C_i \quad \text{and} \quad L_0 \text{ (line adapter (Ex))} > L_i$$

When considering the permitted number of devices and the cable length allowed, it must be noted that all devices are connected to the line adapter (Ex) via the detector line. Therefore, the following applies:

$$C_0 > (n \times C_i) + (l \times C_c)$$

$$L_0 > (n \times L_i) + (l \times L_c)$$

Symbol	Meaning
n	Total number of detectors
C_i	Internal capacity
L_i	Internal inductivity
l	Length of the entire detector line (a + b + c + d)

This leads to the following result in relation to the example under consideration:

$$C_0 > (3 \times C_i(\text{FDOOT241-A9-Ex})) + (1 \times C_i(\text{FDM223-Ex})) + \sum (C_c (\text{total cable lengths}))$$

$$L_0 > (3 \times L_i(\text{FDOOT241-A9-Ex})) + (1 \times L_i(\text{FDM223-Ex})) + \sum (L_c (\text{total cable lengths}))$$

The values in our example give:

$$82 \text{ nF} > (3 \times 0,2 \text{ nF}) + (1 \times 0,2 \text{ nF}) + (0.24 \text{ km} \times 100 \text{ nF/km}) \Rightarrow 24.8 \text{ nF}$$

$$2.9 \text{ mH} > (3 \times 0 \text{ } \mu\text{H}) + (1 \times 0 \text{ } \mu\text{H}) + (0.24 \text{ km} \times 0.5 \text{ mH/km}) \Rightarrow 0.12 \text{ mH}$$

Therefore, this condition is also met.

One could use the same formulas to calculate the maximum permitted cable length too. For example, one would get the following values:

Number of devices on the detector line FDOOT241-A9-Ex or FDM223-Ex	Max. length of detector line (cable capacitance 100 nF/km)	Max. length of detector line (cable capacitance 135 nF/km)
5	810 m = 0.81 km	600 m = 0.6 km
10	800 m = 0.8 km	590 m = 0.59 km
20	780 m = 0.78 km	570 m = 0.57 km

The cable inductance was not calculated, since the cable lengths calculated in the example are far above this level and therefore not crucial.



The values stated above are guides only. The calculation must be performed with the actual values for the cables used.

Alarm indicators

The lines for the alarm indicators FDAI92-Ex, i.e., the cable sections 'e' and 'f', must be considered separately, since the alarm indicators are fed from the point detectors FDOOT241-A9-Ex and these are specified as separate sources.

The cable length can be checked in the same way:

$$C_0 \text{ (point detector)} > C_i \text{ (alarm indicator)} + C_c$$

$$L_0 \text{ (point detector)} > L_i \text{ (alarm indicator)} + L_c$$

Since C_i and L_i are negligible on the alarm indicators, only C_c and L_c have to be considered. The calculation shows that this condition is met too.

System documentation

A graphic recording the system data can now be created for the system documentation. Such a graphic can be found in Annex E of EN 60079-25.

See also

 Product range [[→ 29](#)]

10 Annex B - PTB numbers for older safety barriers

Device name	PTB number
Safety barrier SB2	PTB 01 ATEX 2053 X
Safety barrier SB3	PTB 01 ATEX 2088 X

Glossary

Area at risk of explosion

An area in which a potentially explosive gas atmosphere is present or could occur in quantities that would render special protective measures necessary for constructing, installing, and operating devices. See also EN 60079-10-1.

Associated electrical equipment

Electrical equipment that contains both energy-limited and non-energy-limited circuits, and is structured in such a way that the non-energy-limited circuits cannot have a negative effect on any of the energy-limited circuits.

ATEX

Taken from the French phrase 'ATmosphère EXplosive'.

Certificate

Document confirming that a product, process, system, person, or organization conforms to specified requirements.

Countable fault

Fault affecting parts of the equipment that conform to structural requirements.

Detailed test

Inspection that aims to not only look at the aspects of a close inspection, but also to identify those faults that can only be identified by opening housings and/or, where necessary, using tools and testing equipment (for example, loose connections). See also EN 60079-17.

Electrical devices

All objects which, either in whole or in part, are used for applying electrical energy.

Explosion

An explosion is a chemical reaction or a physical process during which temperature or pressure rises significantly in a short period of time. This results in a sudden expansion in the volume of gases and the release of large quantities of energy in a small space, as a result of blasting agents, potentially explosive atmospheres, or built-up gases, for example.

Explosive atmosphere

Mixture of air under atmospheric conditions with combustible materials in the form of gas, vapor, dust, fibers, or fibrous material, which, after ignition, permits self-sustaining propagation. See also EN 60079-0.

Ignition protection category

The ignition protection category denotes various structural principles. Each ignition protection category is based on the principle of minimizing the risk of a potentially explosive atmosphere and ignition sources being present at the same time.

Inspection

Activity that involves carefully investigating an object with the aim of making a reliable statement about the condition of that object. The activity includes actions such as measurements and is carried out without dismantling the object or, if necessary, only partially dismantling it.

Intrinsically safe circuit

Circuit in which all electrical equipment is either intrinsically safe electrical equipment or simple electrical equipment. See also EN 60079-14.

Maintenance

Planned procedures that are carried out in order to keep the installed equipment in its intended condition. See also EN 60079-19.

Maintenance and troubleshooting

Combination of all activities carried out in order to bring an object into or restore it to a certain condition, where this condition conforms to the relevant specifications and ensures that the required functions can be performed. See also EN 60079-17.

Manufacturer

Manufacturer of the equipment (may also be the supplier, importer, or dealer) in whose name the certification for the equipment, if applicable, was originally recorded. See also EN 60079-19.

Minimum ignition energy

The minimum ignition energy level of a gas and vapor/air mixture is the lowest possible level of electrical energy, occurring when a capacitor is discharged, that may still cause the most ignitable mixture of gas or vapor with air to ignite under atmospheric pressure and 20 °C.

Non-countable fault

Fault affecting parts of the equipment that do not conform to structural requirements.

Operator

User of the equipment. See also EN 60079-19.

Qualified person

A qualified person is someone who, as a result of their professional training and current occupational activities, has the knowledge required to test the work equipment. In some cases, the relevant national ordinances (such as the Ordinance on Industrial Safety and Health in Germany) make distinctions according to different qualification requirements; for example, they may place different requirements on a person's qualifications, skills, and experience.

Repair

Procedure that involves restoring faulty equipment to its correct condition, in line with the relevant standard. The relevant standard is the standard according to which the equipment was originally constructed. See also EN 60079-19.

Simple apparatus

See 'Simple electrical equipment'

Simple electrical equipment

The following are classed as simple electrical equipment: a) passive components (e.g., switches, distribution boxes, resistors, simple semiconductor components) b) energy storage devices comprising individual components in simple circuits with specifically defined characteristic values, for example capacitors or coils, whose values must be taken into account when determining the overall safety of the system c) energy sources, for example thermoelements and photocells, which generate no more than 1.5 V, 100 mA, and 25 mA. Simple electrical equipment must meet all applicable requirements of EN 60079-11. The devices are referred to as 'simple apparatus'.

Test

Activity that involves carefully investigating an object with the aim of making a reliable statement about the condition of that object. The activity includes actions such as measurements and is carried out without dismantling the object or, if necessary, only partially dismantling it. See also EN 60079-17.

Index

A

Associated electrical equipment, 24

Atmospheric conditions, 54

C

Classification of zones

Zone 0, 29

Zone 1, 29

Zone 2, 29

Control panel, 54

D

Danger zones

Zone classification, 20

Detailed test, 41

Device categories, 24, 25

Device groups, 24

Documentation and organization check, 42

Documentation for fire detection system, 8

Download center

URL, 9

E

Earthing, 29

Electrical equipment

Classification into device groups, 24

Labeling, 26

Energy limitation, 47, 53

EPL, 23

Equipment

Associated electrical, 24

Intrinsically safe, 24

Equipotential bonding, 29, 49

Cross-section, 50

Explosion groups, 25, 46

Explosion protection

Primary, 18

Secondary, 18

Structural, 18

Tertiary, 18

Explosion protection document, 35, 37, 42

External influences, 37

F

Flash point, 19

G

Guideline, 34

Guidelines, 8

H

Hazard class

Liquids, 19

I

Ignition protection category, 22

Intrinsic safety, 39

Safety level, 22, 22

Ignition protection category 'Intrinsic safety', 23, 43

EPL, 23

Safety level, 23

Ignition temperature, 19

Intrinsically safe circuit, 28

Intrinsically safe equipment, 24

L

Legal regulations, 34

Line adapter (Ex), 28

FDCL221-Ex, 28

Line adapter (Ex), 51

Liquids

Hazard class, 19

Load restriction, 33

P

Primary explosion protection, 18

Protective spacing, 49

Zone plan, 49

R

Restriction on line length, 33

Risk assessment, 37

S

Safety level, 22, 22

Scope

Guidelines, 34

Legal regulations, 34

Secondary explosion protection, 18

Simple apparatus, 32

Simple electrical equipment, 32

Standards, 8

Structural explosion protection, 18

T

Technical manual

Testing and maintenance work, 39

Temperature classes, 25, 46

Tertiary explosion protection, 18

Test intervals, 40, 41

Z

Zone classification, 20, 35, 37

Zone 0, 21

Zone 1, 21

Zone 2, 21

Zone plan, 46



Issued by
Siemens Switzerland Ltd
Infrastructure & Cities Sector
Building Technologies Division
International Headquarters
Gubelstrasse 22
CH-6301 Zug
Tel. +41 41-724 24 24
www.siemens.com/buildingtechnologies

© 2011-2014 Copyright Siemens Switzerland Ltd
Technical specifications and availability subject to change without notice.