



Acvatix™

## 3-port seat valves PN16 with VXF40.. flanged connection

---

- Grey cast iron valve body
- DN 15...150
- $k_{vs}$  1.9...315 m<sup>3</sup>/h
- Can be equipped with SAX..-electromotoric or SKD..-, SKB..- and SKC..- electrohydraulic actuators

### Use

---

For use in heating, ventilating and air conditioning systems as a control valve for "mixing" or "diverting" functions.  
For closed circuits only.

## Type summary

Product number	DN	$k_{vs}$ [m <sup>3</sup> / h]	$S_v$
VXF40.15-1.9	15	1,9	> 50
VXF40.15-2.5		2,5	
VXF40.15-3		3	
VXF40.15-4		4	
VXF40.25-5	25	5	
VXF40.25-6.3		6,3	
VXF40.25-7.5		7,5	
VXF40.25-10		10	
VXF40.40-12	40	12	
VXF40.40-16		16	
VXF40.40-19		19	
VXF40.40-25		25	
VXF40.50-31	50	31	> 100
VXF40.50-40		40	
VXF40.65-49	65	49	
VXF40.65-63		63	
VXF40.80-78	80	78	
VXF40.80-100		100	
VXF40.100-124	100	124	
VXF40.100-160		160	
VXF40.125-200	125	200	
VXF40.125-250		250	
VXF40.150-300	150	300	
VXF40.150-315		315	

DN = Nominal size

$k_{vs}$  = Nominal flow rate of cold water (5...30 °C) through the fully open valve ( $H_{100}$ ) by a differential pressure of 100 kPa (1 bar)

$S_v$  = Rangeability  $k_{vs} / k_{vr}$

$k_{vr}$  = Smallest  $k_v$  value, at which the flow characteristic tolerances can still be maintained, by a differential pressure of 100 kPa (1 bar)

## Accessories

Product number	Stock No.	Description
ASZ6.5	ASZ6.5	Electric stem heating element, AC 24 V / 30 W, required for media below 0 °C. For electrohydraulic actuators SKD..., SKB..., SKC...
ASZ6.6	S55845-Z108	Electric stem heating element, AC 24 V 30 W, required for media below 0 °C

## Ordering

Example:

Product number	Stock number	Designation	Quantity
VXF40.50-31	VXF40.50-31	3-port seat valve PN16 with flanged connection	1

Delivery

Valves, actuators and accessories are packed and supplied separately.  
The valves are supplied without counter-flanges and without flange gaskets.

Spare parts, Rev. no.

See overview, page 10.

## Equipment combinations

Valves	H <sub>100</sub> [mm]	Actuators							
		SAX.. <sup>3)</sup>		SKD.. <sup>1)</sup>		SKB..		SKC..	
		Mixing	Diverting <sup>2)</sup>	Mixing	Diverting <sup>2)</sup>	Mixing	Diverting <sup>2)</sup>	Mixing	Diverting <sup>2)</sup>
$\Delta p_{max}$ [kPa]									
VXF40.15-1.9	20	300	100	300	100	300	100		
VXF40.15-2.5									
VXF40.15-3									
VXF40.15-4									
VXF40.25-5									
VXF40.25-6.3									
VXF40.25-7.5									
VXF40.25-10									
VXF40.40-12									
VXF40.40-16									
VXF40.40-19									
VXF40.40-25									
VXF40.50-31									
VXF40.50-40									
VXF40.65-49	40	175	60	275	60		70		
VXF40.65-63									
VXF40.80-78									
VXF40.80-100									
VXF40.100-124	40								200
VXF40.100-160									
VXF40.125-200									
VXF40.125-250									
VXF40.150-300									
VXF40.150-315									

<sup>1)</sup> Usable up to maximum medium temperature of 150 °C

<sup>2)</sup> If noise is permitted, the same values apply as for mixing.

<sup>3)</sup> Serie G: Usable up to maximum medium temperature of 130 °C

H<sub>100</sub> = Nominal stroke

$\Delta p_{max}$  = Maximum permissible differential pressure across the valve (mixing: port A-AB, B-AB; diverting: port AB-A, AB-B), valid for the entire actuating range of the motorized valve

## Actuator overview

Product number	Actuator type	Operating voltage	Positioning signal	Spring return	Positioning time	Positioning force	Data sheet	
SAX31.00	Electro-motoric	AC 230 V	3- position	-	120 s	800 N	N4501	
SAX31.03					30 s			
SAX81.00		AC/DC 24 V			120 s			
SAX81.03					DC 0...10 V <sup>1)</sup>			30 s
SAX61.03								
SKD32.50	Electro-hydraulic	AC 230 V	3- position	-	120 s	1000 N	N4561	
SKD32.21					Yes			30 s
SKD32.51								
SKD82.50		AC 24 V			-			120 s
SKD82.51					Yes			
SKD60					-			30 s
SKD62..					Yes			
SKB32.50	Electro-hydraulic	AC 230 V	3- position	-	120 s	2800 N	N4564	
SKB32.51								Yes
SKB82.50								
SKB82.51		AC 24 V						Yes
SKB60		DC 0...10 V <sup>1)</sup>						-
SKB62..								Yes
SKC32.60	Electro-hydraulic	AC 230 V	3- position	-	120 s	2800 N	N4566	
SKC32.61								Yes
SKC82.60								
SKC82.61		AC 24 V						Yes
SKC60		DC 0...10 V <sup>1)</sup>						-
SKC62..								Yes

Actuators SAX81.. and SAX61.. are UL listed

<sup>1)</sup> or DC 4...20 mA or 0...1000 Ω

## Pneumatic actuators

Available on request from your local office.



**Application is possible only if the VXF40.. is used as a mixing valve.**

## Technical design / mechanical design

### Valve cross section

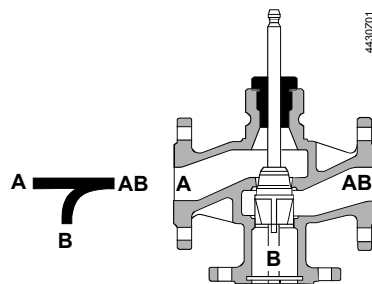

150DN 15... 40  
closes against pressure

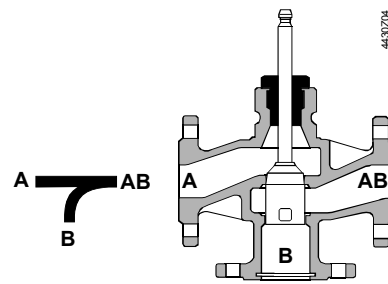

DN 50...150  
closes against pressure

Guided plug which is integrated in the valve stem. The seats are machined in the valve body. Schematic representation, design variations are possible.

Flow diagram  
"Mixing"

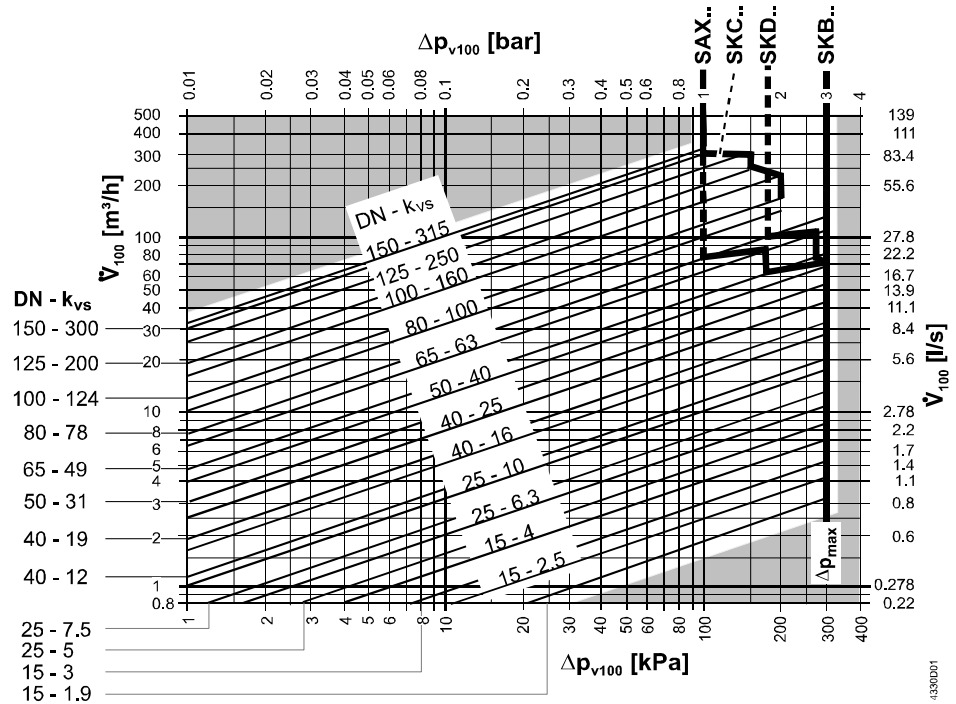

- $\Delta p_{max}$  = Maximum permissible differential pressure across the valve (mixing: port A-AB, B-AB; diverting: port AB-A, AB-B), valid for the entire actuating range of the motorized valve
- $\Delta p_{V100}$  = Differential pressure across the fully open valve and the valve's control path A  $\rightarrow$  AB, B  $\rightarrow$  AB by a volume flow  $V_{100}$
- $\dot{V}_{100}$  = Volumetric flow through the fully open valve ( $H_{100}$ )
- 100 kPa = 1 bar  $\approx$  10 mWC
- 1  $m^3/h$  = 0.278 l/s water at 20 °C

Valve flow characteristic

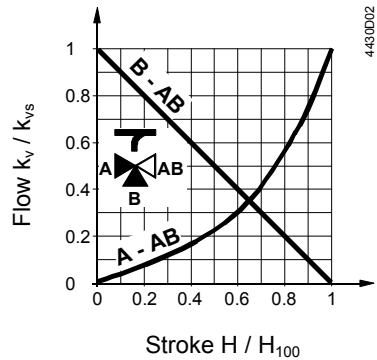

- Through-port**
  - 0...30 %  $\rightarrow$  linear
  - 30...100 %  $\rightarrow n_{gl} = 3$  as per VDI / VDE 2173
- $k_{vs}$ -values 100, 160, 250, 315  $m^3/h$ :
  - 0...30 %  $\rightarrow$  linear
  - 30...75 %  $\rightarrow$  equal-percentage ( $n_{gl} = 3$ ) as per VDI / VDE 2173
  - 75...100 %  $\rightarrow$  optimized for maximal flow  $k_{V100}$
- Bypass**
  - 0...100 %:  $\rightarrow$  linear
- Mixing:**  $\rightarrow$  Flow from port A and port B to port AB
- Diverting:**  $\rightarrow$  Flow from port AB to port A and port B
- Port AB =  $\rightarrow$  constant flow
- Port A =  $\rightarrow$  variable flow
- Port B =  $\rightarrow$  bypass (variable flow)

Use the 3-port valve primarily as a mixing valve.

**Working pressure and medium temperature**

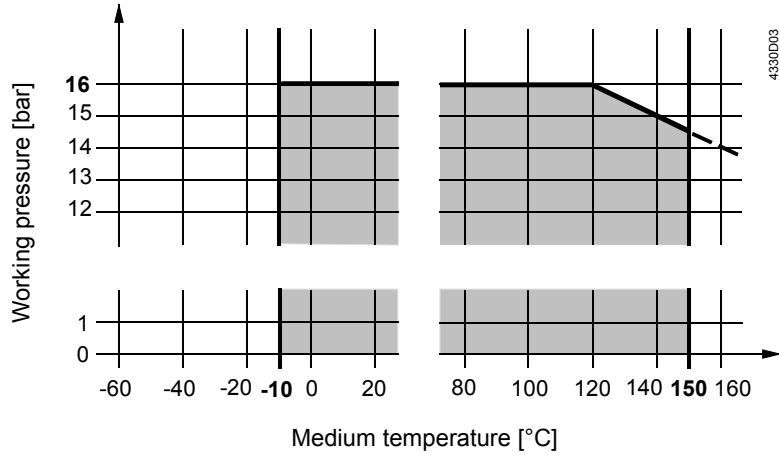

**Working pressure and medium temperature staged as per ISO 7005**

Current local legislation must be observed.

**Notes**

**Engineering**

We recommend installation in the return pipe, as the temperatures in this pipe are lower for applications in heating systems, which in turn, extends the stem sealing gland's life.



Always use a strainer upstream of the valve to increase the valve's functional safety.

For media below 0 °C, use the electric stem heating element to prevent the valve stem from freezing in the sealing gland. For safety reasons, the stem heating element has been designed for AC 24 V / 30 W operating voltage.

**Mounting**

Both valve and actuator can easily be assembled at the mounting location. Neither special tools nor adjustments are required.

The valve is supplied with Mounting Instructions 74 319 0519 0.

**Orientation**

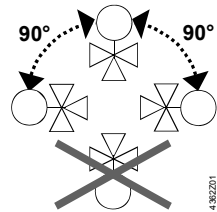

**Direction of flow**

When mounting, pay attention to the valve's flow direction symbol →.

Mixing from A / B to AB



Diverting from AB to A / B



**Commissioning**



**Commission the valve only if the actuator has been mounted correctly.**

Valve stem retracts: through-port A – AB opens, bypass B closes

Valve stem extends: through-port A – AB closes, bypass B opens

## Maintenance

---

### Warning

VXF40.. valves require no maintenance.

When doing service work on the valve / actuator:

- Deactivate the pump and turn off the power supply
- Close the shutoff valves
- Fully reduce the pressure in the piping system and allow pipes to completely cool down

If necessary, disconnect the electrical wires.

Before putting the valve into operation again, make certain the actuator is correctly fitted.

### Stem sealing gland

The glands can be exchanged without removing the valve, provided the pipes are depressurized and cooled off and the stem surface is unharmed.

If the stem is damaged in the gland range, replace the entire stem-plug-unit.

Contact your local office or branch.

### Disposal



Before disposal the valve must be dismantled and separated into its various constituent materials.

Legislation may demand special handling of certain components, or it may be sensible from an ecological point of view.

**Current local legislation must be observed.**

## Warranty

---

The technical data given for these applications is valid only in conjunction with the Siemens actuators as detailed under "Equipment combinations", page 3.

All terms of the warranty will be invalidated by the use of actuators from other manufacturers.

## Technical data

Functional data	PN class	PN 16 to ISO 7268	
	Working pressure	to ISO 7005 within the permissible "medium temperature" range according to the diagram on page 6	
	Flow characteristic		
	through-port	0...30 % linear	
	bypass	30...100 % equal percentage; $n_{gl} = 3$ to VDI / VDE 2173 <sup>1)</sup>	
	Leakage rate		
	through-port	0...0.02 % of $k_{vs}$ value to DIN EN 1349	
	bypass	0.5...2 % of $k_{vs}$ value	
	Permissible media	chilled water, low temperature hot water, high temperature hot water, water with anti-freeze, brine; recommendation: water treatment to VDI 2035	
	Medium temperature <sup>2)</sup>	-10...+150 °C	
	Rangeability $S_v$	DN 15...40: >50 DN 50...150: >100	
	Nominal stroke	DN 15...80: 20 mm DN 100...150: 40 mm	
	Industry standards	Pressure Equipment Directive	PED 97/23/EC
		Pressure Accessories	as per article 1, section 2.1.4
Fluid group 2		DN 15...50 without CE-marking as per article 3, section 3 (sound engineering practice) DN 65...125 category I, with CE-marking DN 150 category II, with CE-marking, test authority number 0036	
Environmental compatibility		ISO 14001 (Environment) ISO 9001 (Quality) SN 36350 (Environmentally compatible products) RL 2002/95/EG (RoHS)	
Materials	Valve body	grey cast iron	
	DN15 .. DN80	EN-GJL-200	
	DN100 .. DN150	EN-GJL-250	
	Stem	stainless steel	
	Plug	DN 15...40: brass DN 50...150: bronze	
	Sealing gland	Brass, silicon-free	
Dimensions / Weight	Gland materials	EPDM O rings, silicon-free	
	Refer to "Dimensions", page 9		
	Flange connections	to ISO 7005	

<sup>1)</sup>  $k_{vs}$ -values 100, 160, 250, 315 m<sup>3</sup>/h: flow characteristic is over 75 % stroke optimized for maximal flow  $k_{v100}$ , see page 5.

<sup>2)</sup> Electric stem heating element required for media below 0 °C.



## Dimensions

Dimensions in mm

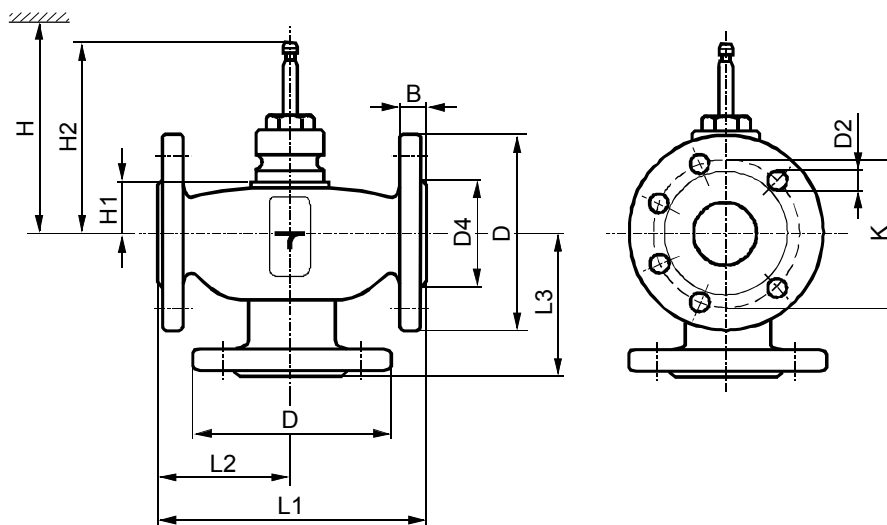

4420M01

Product number	DN	B	D Ø	D2 Ø	D4 Ø	K	L1	L2	L3	H1	H2	H				[kg]
												SAX..	SKD..	SKB..	SKC..	
VXF40.15-1.9	15	14	95	14 (4x)	46	65	130	65	65	40,5	137	> 483,5	> 540	> 615		3,3
VXF40.15-2.5																3,3
VXF40.15-3																3,3
VXF40.15-4																3,3
VXF40.25-5	25	16	115	14 (4x)	65	85	160	80	80	34	130,5	> 476	> 534	> 609		5,1
VXF40.25-6.3																5,1
VXF40.25-7.5																5,1
VXF40.25-10																5,1
VXF40.40-12	40	18	150	19 (4x)	84	110	200	100	100	39	135,5	> 481	> 539	> 614		8
VXF40.40-16																8
VXF40.40-19																8
VXF40.40-25																8
VXF40.50-31	50	20	165	19 (4x)	99	125	230	115	115	60	156,5	> 502	> 560	> 635		10,8
VXF40.50-40																10,8
VXF40.65-49	65	20	185	19 (4x)	118	145	290	145	145	60	156,5	> 502	> 560	> 635		16
VXF40.65-63																16
VXF40.80-78	80	22	200	19 (4x)	132	160	310	155	155	60	156,5	> 502	> 560	> 635		19,3
VXF40.80-100																19,3
VXF40.100-124	10	24	220	19 (8x)	156	180	350	175	175	93	209,5					> 666
VXF40.100-160	0															> 666
VXF40.125-200	12	26	250	19 (8x)	184	210	400	200	200	104	220,5					> 677
VXF40.125-250	5															> 677
VXF40.150-300	15	26	285	23 (8x)	211	240	480	240	240	120	236,5					> 693
VXF40.150-315	0															> 693

DN = Nominal size

H = Total actuator height plus minimum distance to the wall or the ceiling for mounting, connection, operation, maintenance etc.

H1 = Dimension from the pipe centre to install the actuator (upper edge)

H2 = Valve in the «Closed» position means that the stem is fully extended

## Spare parts

Order numbers for spare parts

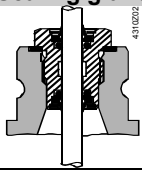
Product number	Sealing gland	Set
		<b>Plug with stem, circlip, sealing</b>
VXF40.15-1.9	4 284 8806 0	74 676 0140 0
VXF40.15-2.5	4 284 8806 0	74 676 0198 0
VXF40.15-3	4 284 8806 0	74 676 0141 0
VXF40.15-4	4 284 8806 0	74 676 0199 0
VXF40.25-5	4 284 8806 0	74 676 0034 0
VXF40.25-6.3	4 284 8806 0	74 676 0200 0
VXF40.25-7.5	4 284 8806 0	74 676 0035 0
VXF40.25-10	4 284 8806 0	74 676 0201 0
VXF40.40-12	4 284 8806 0	74 676 0036 0
VXF40.40-16	4 284 8806 0	74 676 0202 0
VXF40.40-19	4 284 8806 0	74 676 0037 0
VXF40.40-25	4 284 8806 0	74 676 0203 0
VXF40.50-31	4 284 8806 0	74 676 0038 0
VXF40.50-40	4 284 8806 0	74 676 0204 0
VXF40.65-49	4 284 8806 0	74 676 0039 0
VXF40.65-63	4 284 8806 0	74 676 0205 0
VXF40.80-78	4 284 8806 0	74 676 0040 0
VXF40.80-100	4 284 8806 0	74 676 0206 0
VXF40.100-124	4 679 5629 0	74 676 0088 0
VXF40.100-160	4 679 5629 0	74 676 0207 0
VXF40.125-200	4 679 5629 0	74 676 0089 0
VXF40.125-250	4 679 5629 0	74 676 0208 0
VXF40.150-300	4 679 5629 0	74 676 0090 0
VXF40.150-315	4 679 5629 0	74 676 0090 0

## Revision numbers

Product number	Valid from rev. no.	Product number	Valid from rev. no.	Product number	Valid from rev. no.
VXF40.15-1.9	..B	VXF40.40-12	..B	VXF40.80-78	..B
VXF40.15-2.5	..B	VXF40.40-16	..B	VXF40.80-100	..B
VXF40.15-3	..B	VXF40.40-19	..B	VXF40.100-124	..B
VXF40.15-4	..B	VXF40.40-25	..B	VXF40.100-160	..B
VXF40.25-5	..B	VXF40.50-31	..B	VXF40.125-200	..B
VXF40.25-6.3	..B	VXF40.50-40	..B	VXF40.125-250	..B
VXF40.25-7.5	..B	VXF40.65-49	..B	VXF40.150-300	..B
VXF40.25-10	..B	VXF40.65-63	..B	VXF40.150-315	..B