



Acvatix™

## 2-port seat valves PN6 with flanged connection VVF21..

---

- Grey cast iron valve body
- DN 25...100
- $K_{vs}$  1.9...160 m<sup>3</sup>/h
- Can be equipped with SAX.. electromotoric or SKD..-, SKB..- and SKC..- electrohydraulic actuators

### Use

---

For use in heating, ventilating, and air conditioning systems as a control or safety shutoff valve.

For closed circuits only (mind "Cavitation", refer to page 6).

## Type summary

Product number	DN	$k_{vs}$ [m <sup>3</sup> / h]	$S_v$	
VVF21.22	25	1,9	> 50	
VVF21.25-2.5		2,5		
VVF21.23		3		
VVF21.25-4		4		
VVF21.24		5		
VVF21.25-6.3		6,3		
VVF21.25		7,5		
VVF21.25-10		10		
VVF21.39	40	12		
VVF21.40-16		16		
VVF21.40		19		
VVF21.40-25		25		
VVF21.50	50	31		> 100
VVF21.50-40		40		
VVF21.65	65	49		
VVF21.65-63		63		
VVF21.80	80	78		
VVF21.80-100		100		
VVF21.90	100	124		
VVF21.100-160		160		

DN = Nominal size

$k_{vs}$  = Nominal flow rate of cold water (5...30 °C) through the fully open valve ( $H_{100}$ ) by a differential pressure of 100 kPa (1 bar)

$S_v$  = Rangeability  $k_{vs} / k_{vr}$

$k_{vr}$  = Smallest  $k_v$  value, at which the flow characteristic tolerances can still be maintained, by a differential pressure of 100 kPa (1 bar)

## Accessories

Product number	Stock No.	Description
ASZ6.5	ASZ6.5	Electric stem heating element, AC 24 V / 30 W, required for media below 0 °C. For electrohydraulic actuators SKD..., SKB..., SKC...
ASZ6.6	S55845-Z108	Electric stem heating element, AC 24 V 30 W, required for media below 0 °C

## Ordering

Example:

Product number	Stock number	Designation	Quantity
VVF21.50	VVF21.50	2-port seat valve PN6 with flanged connection	1

Delivery

Valves, actuators and accessories are packed and supplied separately.  
The valves are supplied without counter-flanges and without flange gaskets.

Spare parts, Rev. no.

See overview, page 10.

## Equipment combinations

Valves	Actuators								
	H <sub>100</sub> [mm]	SAX.. <sup>2)</sup>		SKD.. <sup>1)</sup>		SKB..		SKC..	
		$\Delta p_{max}$	$\Delta p_s$	$\Delta p_{max}$	$\Delta p_s$	$\Delta p_{max}$	$\Delta p_s$	$\Delta p_{max}$	$\Delta p_s$
[kPa]									
VVF21.22	20	300	600	300	600	300	600		
VVF21.25-2.5									
VVF21.23									
VVF21.25-4									
VVF21.24									
VVF21.25-6.3									
VVF21.25									
VVF21.25-10									
VVF21.39									
VVF21.40-16									
VVF21.40									
VVF21.40-25									
VVF21.50									
VVF21.50-40									
VVF21.65									
VVF21.65-63									
VVF21.80	100	100	175	175		500			
VVF21.80-100									
VVF21.90	40							200	300
VVF21.100-160									

<sup>1)</sup> Usable up to maximum medium temperature of 150 °C

<sup>2)</sup> Serie G: Usable up to maximum medium temperature of 130 °C

H<sub>100</sub> = Nominal stroke

$\Delta p_{max}$  = Maximum permissible differential pressure across valve's control path, valid for the entire actuating range of the motorized valve

$\Delta p_s$  = Maximum permissible differential pressure at which the motorized valve will close securely against the pressure (close off pressure)

## Actuator overview

Product number	Actuator type	Operating voltage	Positioning signal	Spring return	Positioning time	Positioning force	Data sheet	
SAX31.00	Electro-motoric	AC 230 V	3- position	-	120 s	800 N	N4501	
SAX31.03					30 s			
SAX81.00		AC/DC 24 V			120 s			
SAX81.03					DC 0...10 V <sup>1)</sup>			30 s
SAX61.03								
SKD32.50	Electro-hydraulic	AC 230 V	3- position	-	120 s	1000 N	N4561	
SKD32.21					30 s			
SKD32.51					Yes			
SKD82.50		AC 24 V			-			
SKD82.51					Yes			
SKD60					-			
SKD62..					DC 0...10 V <sup>1)</sup>			30 s
SKB32.50	Electro-hydraulic	AC 230 V	3- position	-	120 s	2800 N	N4564	
SKB32.51								Yes
SKB82.50		-						
SKB82.51		Yes						
SKB60		-						
SKB62..		DC 0...10 V <sup>1)</sup>						Yes
SKC32.60	Electro-hydraulic	AC 230 V	3- position	-	120 s	2800 N	N4566	
SKC32.61								Yes
SKC82.60		-						
SKC82.61		Yes						
SKC60		-						
SKC62..		DC 0...10 V <sup>1)</sup>						Yes

Actuators SAX81.. and SAX61.. are UL listed  
<sup>1)</sup> or DC 4...20 mA or 0...1000 Ω

## Pneumatic actuators

Pneumatic actuators are available on request from your local office.

## Technical design / mechanical design

### Valve cross section

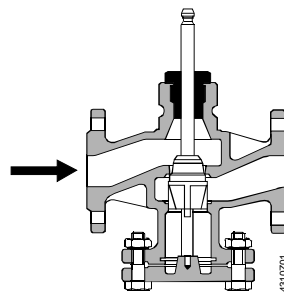

DN 25 and DN 40  
closes against pressure

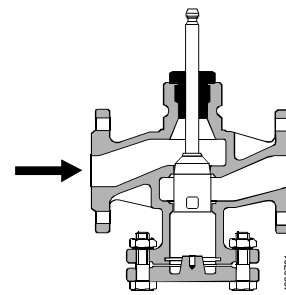

DN 50...100  
closes against pressure

Guided plug which is integrated in the valve stem. The seat is machined in the valve body. Schematic representation, design variations are possible.



**The two-port seat valve does not become a three-port valve by removing the blank flange.**

Flow diagram

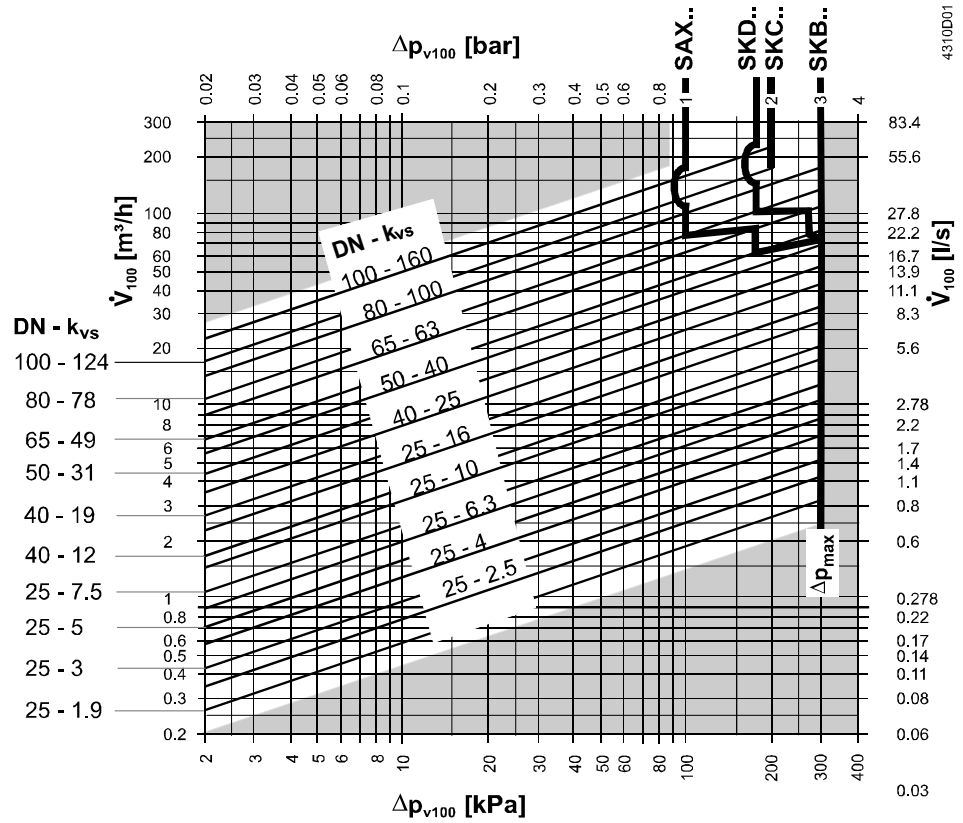

- $\Delta p_{max}$  = Maximum permissible differential pressure across the valve's control path, valid for the entire actuating range of the motorized valve
- $\Delta p_{v100}$  = Differential pressure across the fully open valve by a volume flow  $\dot{V}_{100}$
- $\dot{V}_{100}$  = Volumetric flow through the fully open valve ( $H_{100}$ )
- 100 kPa = 1 bar = 10 mWC
- 1 m<sup>3</sup>/h = 0.278 l/s water at 20 °C

Valve flow characteristic

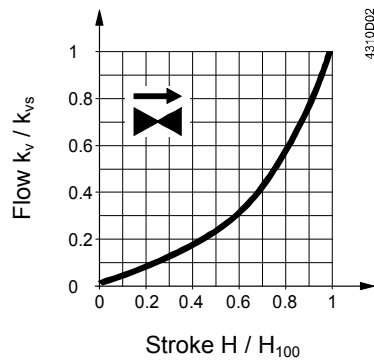

- 0...30 % → linear
- 30...100 % → equal percentage  
 $n_{gl} = 3$  as per VDI / VDE 2173
- $k_{vs}$ -values 100, 160 m<sup>3</sup>/h:
- 0...30 % → linear
- 30...75 % → equal-percentage ( $n_{gl} = 3$ )  
as per VDI / VDE 2173
- 75...100 % → optimized for maximal flow  $k_{v100}$

**Cavitation**

Cavitation accelerates wear on the valve plug and seat, and also results in undesirable noise. Cavitation can be avoided by not exceeding the differential pressure shown in the "Flow diagram" on page 5, and by adhering to the static pressures shown below.

**Note on chilled water**

To avoid cavitation in chilled water circuits ensure sufficient counter pressure at valve outlet, e.g. by a throttling valve after the heat exchanger. Select the pressure drop across the valve at maximum according to the 80 C curve in the flow diagram below.

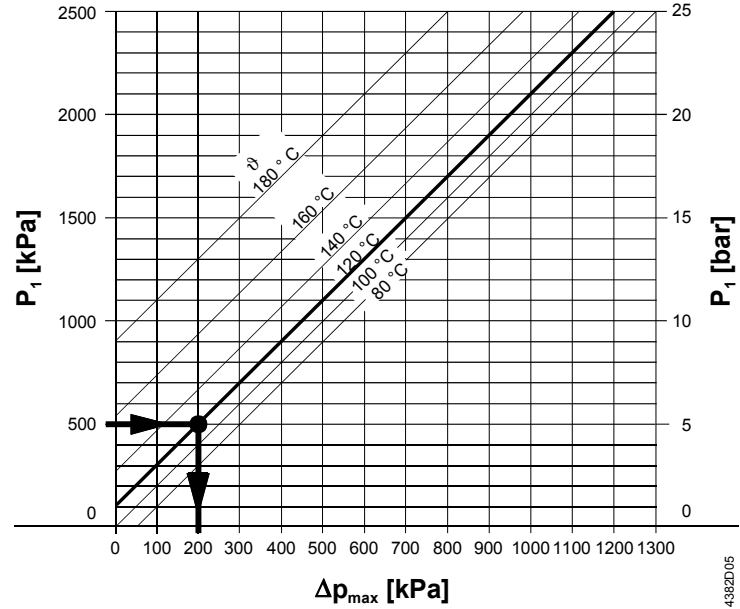

- $\Delta p_{max}$  = Differential pressure with valve almost closed, at which cavitation can largely be avoided
- $p_1$  = Static pressure at inlet
- $p_3$  = Static pressure at outlet
- M = Pump
- $\vartheta$  = Water temperature

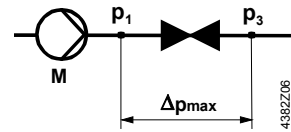

High temperature hot water example:

Pressure  $p_1$  at valve inlet: 500 kPa (5 bar)  
 Water temperature: 120 °C

From the diagram above, it will be seen that with the valve almost closed, the maximum permissible differential pressure  $\Delta p_{max}$  is 200 kPa (2 bar).

## Working pressure and medium temperature

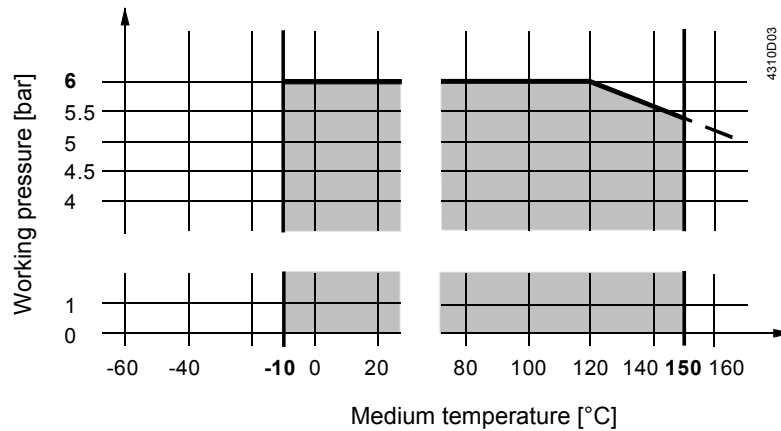

## Working pressure and medium temperature staged as per ISO 7005

Current local legislation must be observed.

## Notes

### Engineering

We recommend installation in the return pipe, as the temperatures in this pipe are lower for applications in heating systems, which in turn, extends the stem sealing gland's life.



Always use a strainer upstream of the valve to increase the valve's functional safety.



For media below 0 °C, use the electric stem heating element to prevent the valve stem from freezing in the sealing gland. For safety reasons, the stem heating element has been designed for AC 24 V / 30 W operating voltage.

### Mounting

Both valve and actuator can easily be assembled at the mounting location. Neither special tools nor adjustments are required.

The valve is supplied with Mounting Instructions 74 319 0509 0.

### Orientation

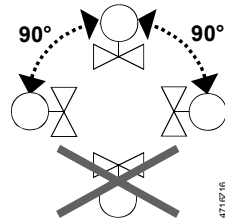

### Direction of flow

When mounting, pay attention to the valve's flow direction symbol →.

### Commissioning



**Commission the valve only if the actuator has been mounted correctly.**

Valve stem retracts: valve opens = increasing flow

Valve stem extends: valve closes = decreasing flow

## Maintenance

### Warning



VVF21.. valves require no maintenance.

When doing service work on the valve / actuator:

- Deactivate the pump and turn off the power supply
- Close the shutoff valves
- Fully reduce the pressure in the piping system and allow pipes to completely cool down

If necessary, disconnect the electrical wires.

Before putting the valve into operation again, make certain the actuator is correctly fitted.

## Stem sealing gland

The glands can be exchanged without removing the valve, provided the pipes are depressurized and cooled off and the stem surface is unharmed.  
If the stem is damaged in the gland range, replace the entire stem-plug-unit.  
Contact your local office or branch.

## Disposal



Before disposal the valve must be dismantled and separated into its various constituent materials.

Legislation may demand special handling of certain components, or it may be sensible from an ecological point of view.

**Current local legislation must be observed.**

## Warranty

The technical data given for these applications is valid only in conjunction with the Siemens actuators as detailed under "Equipment combinations", page 3.  
All terms of the warranty will be invalidated by the use of actuators from other manufacturers.

## Technical data

Functional data	PN class	PN 6 to ISO 7268	
	Working pressure	to ISO 7005 within the permissible "medium temperature" range according to the diagram on page 7	
	Flow characteristic	• 0...30 % • 30...100 % • linear • equal percentage; $n_{qi} = 3$ to VDI / VDE 2173 <sup>1)</sup>	
	Leakage rate	0...0.02 % of $k_{vs}$ value to DIN EN 1349	
	Permissible media	chilled water, low temperature hot water, high temperature hot water, water with anti-freeze, brine; recommendation: water treatment to VDI 2035	
	Medium temperature <sup>2)</sup>	-10...+150 °C	
	Rangeability $S_v$	to DN 40: >50 DN 50...100: >100	
	Nominal stroke	DN 25...80: 20 mm DN 100: 40 mm	
	Industry standards	Pressure Equipment Directive	PED 97/23/EC
		Pressure Accessories	as per article 1, section 2.1.4
Fluid group 2		without CE-marking as per article 3, section 3 (sound engineering practice)	
Environmental compatibility		ISO 14001 (Environment) ISO 9001 (Quality) SN 36350 (Environmentally compatible products) RL 2002/95/EG (RoHS)	
Materials	Valve body	grey cast iron	
	DN25 .. DN80	EN-GJL-200	
	DN100	EN-GJL-250	
	Stem	stainless steel	
	Plug	DN 25...40: brass DN 50...100: bronze	
	Sealing gland	Brass, silicon free	
Gland materials	EPDM O rings, silicon free		
Dimensions / Weight	Refer to "Dimensions", page 9		
	Flange connections	to ISO 7005	

<sup>1)</sup>  $k_{vs}$ -values 100, 160 m<sup>3</sup>/h: flow characteristic is over 75 % stroke optimized for maximal flow  $k_{v100}$ , see page 5.

<sup>2)</sup> Electric stem heating element required for media below 0 °C



## Dimensions

Dimensions in mm

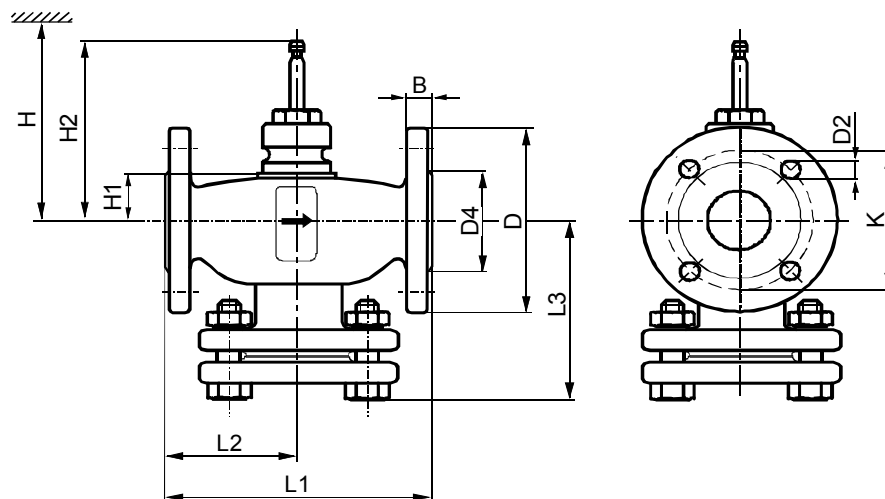

4310M01

Product number	DN	B	D Ø	D2 Ø	D4 Ø	K	L1	L2	L3	H1	H2	H				[kg]
												SAX..	SKD..	SKB..	SKC..	
VVF21.22	25	14	100	11 (4x)	58	75	150	75	96	34	130,5	> 476	> 534	> 609		4,5
VVF21.25-2.5																
VVF21.23																
VVF21.25-4																
VVF21.24																
VVF21.25-6.3																
VVF21.25																
VVF21.25-10																
VVF21.39	40	16	130	14 (4x)	78	100	180	90	112	39	135,5	> 481	> 539	> 614		8
VVF21.40-16																
VVF21.40																
VVF21.40-25																
VVF21.50																
VVF21.50-40																
VVF21.65	65	160	140	14 (4x)	88	110	200	100	122	60	156,5	> 502	> 560	> 635		9,1
VVF21.65-63																
VVF21.80																
VVF21.80-100	80	18	190	19 (4x)	108	130	240	120	142	91	207,5	> 502	> 560	> 635		12,8
VVF21.90																
VVF21.100-160	100		210		124	150	260	130	156							18
					144	170	300	150	176	91	207,5				> 666	27

DN = Nominal size

H = Total actuator height plus minimum distance to the wall or the ceiling for mounting, connection, operation, maintenance etc.

H1 = Dimension from the pipe centre to install the actuator (upper edge)

H2 = Valve in the «Closed» position means that the stem is fully extended

## Spare parts

Order number for spare parts

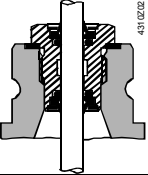
Product number	Sealing gland	Set
		<b>Plug with stem, circlip, sealing</b>
VVF21.22	4 284 8806 0	74 676 0140 0
VVF21.25-2.5	4 284 8806 0	74 676 0198 0
VVF21.23	4 284 8806 0	74 676 0141 0
VVF21.25-4	4 284 8806 0	74 676 0199 0
VVF21.24	4 284 8806 0	74 676 0034 0
VVF21.25-6.3	4 284 8806 0	74 676 0200 0
VVF21.25	4 284 8806 0	74 676 0035 0
VVF21.25-10	4 284 8806 0	74 676 0201 0
VVF21.39	4 284 8806 0	74 676 0036 0
VVF21.40-16	4 284 8806 0	74 676 0202 0
VVF21.40	4 284 8806 0	74 676 0037 0
VVF21.40-25	4 284 8806 0	74 676 0203 0
VVF21.50	4 284 8806 0	74 676 0038 0
VVF21.50-40	4 284 8806 0	74 676 0204 0
VVF21.65	4 284 8806 0	74 676 0039 0
VVF21.65-63	4 284 8806 0	74 676 0205 0
VVF21.80	4 284 8806 0	74 676 0040 0
VVF21.80-100	4 284 8806 0	74 676 0206 0
VVF21.90	4 679 5629 0	74 676 0088 0
VVF21.100-160	4 679 5629 0	74 676 0207 0

## Revision numbers

Product number	Valid from rev. no.	Product number	Valid from rev. no.	Product number	Valid from rev. no.
VVF21.22	..B	VVF21.25-10	..B	VVF21.65	..B
VVF21.25-2.5	..B	VVF21.39	..B	VVF21.65-63	..B
VVF21.23	..B	VVF21.40-16	..B	VVF21.80	..B
VVF21.25-4	..B	VVF21.40	..B	VVF21.80-100	..B
VVF21.24	..B	VVF21.40-25	..B	VVF21.90	..B
VVF21.25-6.3	..B	VVF21.50	..B	VVF21.100-160	..B
VVF21.25	..B	VVF21.50-40	..B		