

Metering



Impeller type heat and heat/cooling energy meters

WFX5..

Electronic, mains-independent impeller type meters with optional cooling range to acquire heat or cooling energy consumption in autonomous heating, cooling or solar plants.

- **Nominal flow rate 0.6 m³/h, 1.5 m³/h or 2.5 m³/h**
- **Optional communicating add-on modules**
- **No settling paths required (neither upstream nor downstream)**
- **Mounting position horizontal or vertical**
- **Setting of device-specific parameters on the meter itself in the field via buttons or operating and parameterization software ACT50**
- **Optical interface**
- **Self-diagnostics**

Use

The electronic, mains-independent impeller type heat and cooling energy meter is of compact design and used for the physically correct acquisition of energy consumption. The meter consists of a flow measuring section, two ready connected temperature sensors and an integrated processor which – based on flow rate and temperature differential – calculates the energy consumption.

The meter is available for heat, combined heat/cooling or solar energy metering.

It is used primarily in plants with central production of heat or cooling energy, where the energy is supplied via zones to several individual consumers in a building. Such buildings include:

- Multi-family houses
- Office and administrative buildings

Typical users:

- Service and billing providers
- Housing industry and housing cooperatives
- Building service companies and real estate agencies

Restrictions

Temperature sensors and battery of the WFX5.. cannot be replaced. The meter is not approved for use in drinking water systems.

Sets

For available heat and heat/cooling energy meter sets, refer to Data Sheet A6V10425530_en--_a.

Functions

Basic design

The meter comprises a flow and return temperature sensor and a flow sensor installed in a hot water or cooling water circuit. A processor calculates continuously the temperature differential of flow and return and multiplies the value by the flow rate. The result (the current heat or cooling energy output) is cumulated, displayed and forwarded by an optional add-on module via radio or cable to a data processing system.

The processor is powered by a long-life battery which ensures 10 years of operation.

Impeller type measuring principle

The meter's flow sensor (volume meter) works accordingly to the single-jet impeller sensor principle. The water flow hits the impeller radially. The impeller's speed is scanned electronically. Incorrect direction of flow is detected and indicated on the display in the form of an error message.

Calculation of heat or cooling energy consumption

Using the acquired temperature differential of flow and return, the flow rate and the calculated thermal coefficient, the quantity of heat or cooling energy is shown on the display in physical units (kWh or MWh/MJ or GJ) following an internal calculation process. To increase measuring accuracy, the density and enthalpy values are determined for every measurement and included in the calculation.

Processor	The same standard processor with a built-in service unit is used for all flow rates.
Infrared interface	Consumption meters with optical close-range interface must be read out on site. The meter is read out and parameterized with the WFZ.IRDA-USB optical reading head and the associated ACT50-heat software.
Module interface	Every meter is equipped with a module interface. When the respective optional add-on module is fitted, the meter can be read out from a remote location.
Tampering	The meter is protected by a factory-fitted seal.
Function check	The temperature is acquired at 36-second intervals (optionally at 6-second intervals). The flow is acquired continuously. The amount of energy supplied is displayed in real time. Any errors are immediately shown.

Type summary

Features of the impeller type meters listed below:

Mounting location	Return
Design	Processor combined with flow measuring section
Rated pressure	PN 16
Sensor mounting	Return temperature sensor, integrated in the flow measuring section
Type of sensing element	Pt1000, Ø5.0 mm, length 45 mm
Temperature sensor cable length	1.5 m
Communication	IrDA and module interface
Threshold value for ...	
- acquisition of heat	1.0 K
- acquisition of cooling energy	0.2 K
Due date	31.12. (December 31)
Display	kWh

Heat meters

Options	Stock no.	Product no.
0.6 m ³ /h, mounting length 110 mm, connecting thread G ¾"	S55561-F177	WFM501-E000H0
1.5 m ³ /h, mounting length 110 mm, connecting thread G ¾"	S55561-F178	WFM502-E000H0
2.5 m ³ /h, mounting length 130 mm, connecting thread G 1"	S55561-F179	WFM503-J000H0

Combined heat/cooling energy meters and additional types are available on request.

Add-on modules

<i>Description</i>	<i>Stock no.</i>	<i>Product no.</i>
M-bus module	S55563-F131	WFZ51
AMR with integrated antenna	S55563-F132	WFZ56.OK
AMR with remote antenna	JXF:WFZ56.OF	WFZ56.OF
Walk-by with integrated antenna	S55563-F133	WFZ566.OK
Walk-by with remote antenna	JXF:WFZ566.OF	WFZ566.OF

**Installation sets
ball valves**

<i>Description</i>	<i>Stock no.</i>	<i>Product no.</i>
Installation set Rp ½" , consisting of: 2 ball valves Rp ½" with couplingnut G ¾" and flat gasket 2 mm, ¾" 1 ball valve Rp ½" with thread M10x1 mm for fitting temperature sensor Ø 5.0x45 mm	JXF:HMXIK001:001	HMXIK001-001
Installation set Rp ¾" , consisting of: 2 ball valves Rp ¾" with coupling nut G ¾" and flat gasket 2 mm, ¾" 1 ball valve Rp ¾" with thread M10x1 mm for fitting temperature sensor Ø 5.0x45 mm	JXF:HMXIK001:002	HMXIK001-002
Installation set Rp 1" , consisting of: 2 ball valves Rp 1" with coupling nut G ¾" and flat gasket 2 mm, ¾" 1 ball valve Rp 1" with thread M10x1 mm for fitting temperature sensor Ø 5.0x45 mm	JXF:HMXIK001:003	HMXIK001-003
Installation set Rp 1" , consisting of: 2 ball valves Rp 1" with coupling nut G 1" and flat gasket 2 mm, 1" 1 ball valve Rp 1" with thread M10x1 mm for fitting temperature sensor Ø 5.0x45 mm	JXF:HMXIK001:004	HMXIK001-004
Installation set Rp ¾" , consisting of: 2 ball valves Rp ¾" with coupling nut G 1" and flat gasket 2 mm, 1" 1 ball valve Rp 1" with thread M10x1 mm for fitting temperature sensor Ø 5.0x45 mm	JXF:HMXIK001:005	HMXIK001-005

Installation set fittings

<i>Description</i>	<i>Stock no.</i>	<i>Product no.</i>
Installation set R ½" , consisting of: 2 fittings R ½" with coupling nut G ¾" and flat gasket 2 mm, ¾" 1 ball valve Rp ½" with thread M10x1 mm for fitting temperature sensor Ø 5.0x45 mm	JXF:HMXIK002:001	HMXIK002-001
Installation set R ¾" , consisting of: 2 fittings R ¾" with coupling nut G ¾" and flat gasket 2 mm, ¾" 1 ball valve Rp ¾" with thread M10x1 mm for fitting temperature sensor Ø 5.0x45 mm	JXF:HMXIK002:002	HMXIK002-002
Installation set R 1" , consisting of: 2 fittings R 1" with coupling nut G ¾" and flat gasket 2 mm, ¾" 1 ball valve Rp 1" with thread M10x1 mm for fitting temperature sensor Ø 5.0x45 mm	JXF:HMXIK002:003	HMXIK002-003
Installation set R 1" , consisting of: 2 fittings R 1" with coupling nut G 1" and flat gasket 2 mm, 1" 1 ball valve Rp 1" with thread M10x1 mm for fitting temperature sensor Ø 5.0x45 mm	JXF:HMXIK002:004	HMXIK002-004
Installation set R ¾" , consisting of: 2 fittings R ¾" with coupling nut G 1" and flat gasket 2 mm, 1" 1 ball valve Rp 1" with thread M10x1 mm for fitting temperature sensor Ø 5.0x45 mm	JXF:HMXIK002:005	HMXIK002-005

Spacers

<i>Description</i>	<i>Stock no.</i>	<i>Product no.</i>
Spacer G ¾" , length 80 mm	JXF:FKM0070	FKM0070
Spacer G ¾" , length 110 mm	JXF:FKM0074	FKM0074
Spacer G 1" , length 130 mm	JXF:FKM0075	FKM0075

Extensions

<i>Description</i>	<i>Stock no.</i>	<i>Product no.</i>
Adapter set from G ¾" to G 1" , consisting of: 2 adapter pieces from G ¾" to G 1" 2 flat gaskets 2 mm, 1"	JXF:HMXIK003:001	HMXIK003-001
Extension set from G ¾" to G 1" , consisting of: 2 adapter pieces from 110 mm G ¾" to 130 mm G 1" 2 flat gaskets 2 mm, 1"	JXF:HMXIK003:002	HMXIK003-002
Extension set from 110 mm G ¾" to 130 mm G ¾" , consisting of: 1 extension 27 mm 2 flat gaskets 2 mm, ¾" 1 gasket made of copper ¾" x 1.5 mm	JXF:HMXIK003:003	HMXIK003-003
Extension set from 110 mm G ¾" to 165 mm G ¾" , consisting of: 1 extension 27 mm 1 extension 42 mm 2 flat gaskets 2 mm, ¾" 2 gaskets made of copper ¾" x 1.5 mm	JXF:HMXIK003:004	HMXIK003-004
Extension set from 110 mm G ¾" to 190 mm G 1" , consisting of: 1 adapter pieces from 110 mm G ¾" to 190 mm G 1" 2 flat gaskets 2 mm, 1" 2 gaskets made of copper ¾" x 1.5 mm	JXF:HMXIK003:005	HMXIK003-005

Fittings

<i>Description</i>	<i>Stock no.</i>	<i>Product no.</i>
Fitting R ½" x G ¾" , without gasket	JXF:FKM0018	FKM0018
Fitting R ¾" x G ¾" , without gasket	JXF:FKM0019	FKM0019
Fitting R 1" x G ¾" , without gasket	JXF:FKM0020	FKM0020
Fitting R ¾" x G 1" , without gasket	JXF:FKM0021	FKM0021
Fitting R 1" x G 1" , without gasket	JXF:FKM0022	FKM0022

Ball valves

<i>Description</i>	<i>Stock number</i>	<i>Product no.</i>
Ball valve Rp ½" with thread M10x1 mm for fitting temperature sensor Ø 5.0x45 mm	JXF:FKM0023	FKM0023
Ball valve Rp ¾" with thread M10x1 mm for fitting temperature sensor Ø 5.0x45 mm	JXF:FKM0024	FKM0024
Ball valve Rp 1" with thread M10x1 mm for fitting temperature sensor Ø 5.0x45 mm	JXF:FKM0025	FKM0025
Ball valve Rp ½" with coupling nut G ¾" and thread M10x1 for fitting temperature sensor Ø 5.0x45 mm	JXF:FKM0026	FKM0026
Ball valve R ½" with coupling nut G ¾"	JXF:FKM0076	FKM0076
Ball valve R ¾" with coupling nut G ¾"	JXF:FKM0028	FKM0028
Ball valve R 1" with coupling nut G ¾"	JXF:FKM0029	FKM0029
Ball valve R ¾" with coupling nut G 1"	JXF:FKM0030	FKM0030
Ball valve R 1" with coupling nut G 1"	JXF:FKM0031	FKM0031

Accessories

<i>Description</i>	<i>Stock no.</i>	<i>Product no.</i>
Flat gasket ¾" , 2 mm thick	JXF:FKS0005	FKS0005
Flat gasket 1" , 2 mm thick	JXF:FKS0006	FKS0006
T-piece R ½" x G ¼"	JXF:FKM0035	FKM0035
T-piece R ¾" x G ¼"	JXF:FKM0036	FKM0036
T-piece R 1" x G ¼"	JXF:FKM0037	FKM0037
Immersion sleeve G ¼" for sensor Ø 5.0x45 mm, without gasket	JXF:FKM0038	FKM0038
Immersion sleeve M10x1 mm for sensor Ø 5.0x45 mm, without gasket	JXF:FKM0051	FKM0051
Immersion sleeve G ¼" for sensor Ø 5.2 mm, without gasket	JXF:FKM0039	FKM0039
Immersion sleeve M10x1 mm for sensor Ø 5.2 mm, without gasket	JXF:FKM0052	FKM0052
Temperature sensor screwed , connection made of brass for sensor Ø 5.0 or Ø 5.2 mm, directly or indirectly immersed	JXF:HMXIK004:001	HMXIK004-001
Wall bracket for WFx5 heat meter	JXF:HMRİK001:001	HMRİK001-001
Seal , wire length 250 mm	JXF:FNS0001	FNS0001

Software	Options	Stock no.	Product no.
	Infrared read head with USB interface	JXF:WFZ.IRDA-USB	WFZ.IRDA-USB
	Parameterization and diagnostic software	JXF:ACT50-Heat	ACT50-Heat

Ordering

When ordering, please give quantity, description, product no. and stock no.

Order numbers	Product no.	Stock no.	Description
	WFx5..	See product nos. under "Type summary"	Impeller type heat meters

Scope of delivery The meters come complete with Operating and Installation Instructions in different languages including the required mounting material (gaskets, seals, etc.).

Languages The Operating and Installation Instructions are supplied in 18 languages:
Bulgarian, Croatian, Czech, Dutch, English, Finnish, French, German, Greek, Hungarian, Italian, Lithuanian, Norwegian, Polish, Slovakian, Slovenian, Spanish and Turkish.

**Screwed type meter
pressure drop
characteristic
0.6 m³/h, 110 mm**

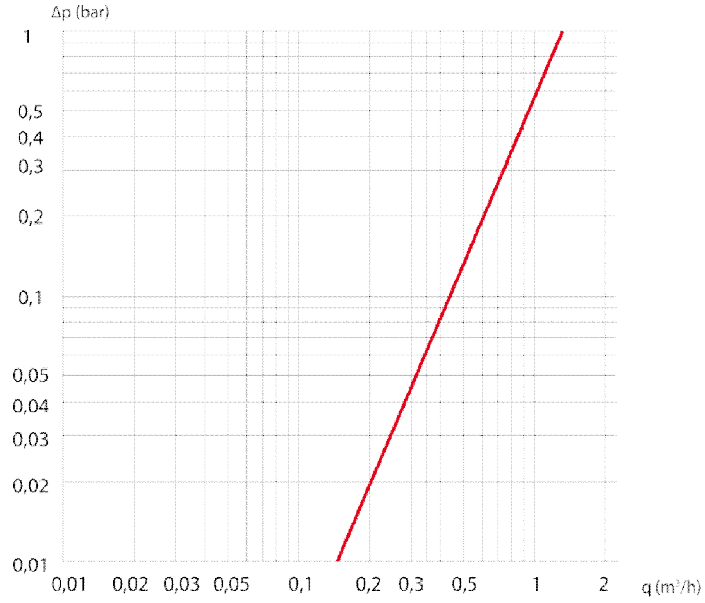

**Screwed type meter
pressure drop
characteristic
1.5 m³/h, 80 mm and
110 mm**

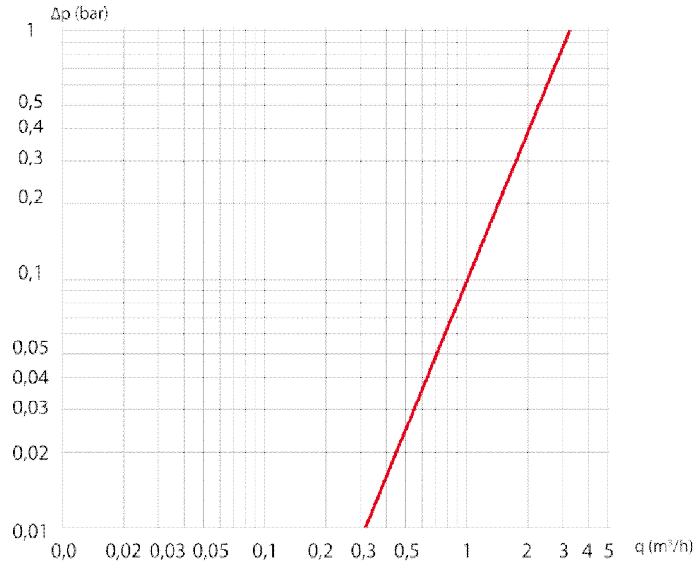

**Screwed type meter
pressure drop
characteristic
2.5 m³/h, 130 mm**

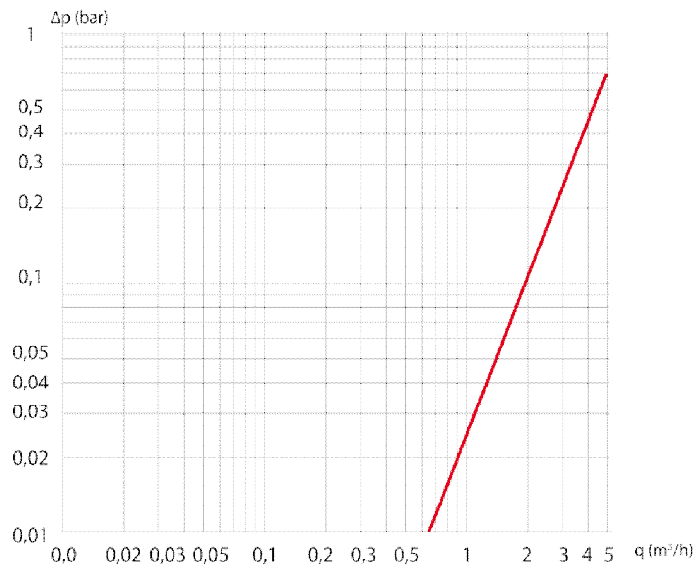

Standard parameters

The meters are supplied with the following parameter settings:

- Due date: 31.12. (December 31)
- Display of consumption in kWh

All display levels are shown.

The heat or cooling energy consumption values are continuously cumulated. The current state is stored at 24:00 o'clock on the due date.

Every time current and annual consumption are stored, the heat meter calculates a checksum. This can be read out together with the due date value and checked in the billing program. This allows incorrect display readouts to be detected. The stored due date value remains in place for one year.

Parameter settings via PC

The following parameters are read out or set with the ACT50 software via the optical close-range interface:

Generally

- Serial number
- Mounting place
- Installation location
- Firmware version
- Medium
- Date of commissioning
- Remaining battery life
- Article number
- Heat carrier
- Error date
- Error code

Device information

- Current temperature (return)
- Current temperature (flow)
- Current temperature (difference)
- Current energy flow
- Current flow rate
- Total flow rate
- Pulse value
- Device name

Meter statuses

- Current meter status
- Last due date
- Meter status on last due date
- Next due date
- Supply flow:
 - Maximum temperature
 - Date of maximum temperature
 - Duration of upper deviations
- Return flow:
 - Maximum temperature
 - Date of maximum temperature
 - Duration of upper deviations
- Flow:
 - Maximum flow rate
 - Date of maximum flow rate
 - Duration of upper deviations
- Statistical values:
 - 15 monthly values with date

Parameter settings via the meter

Using the 2 buttons, the following parameters can be set directly on the meter:

- Next due date
- Display of kWh or MWh/MJ or GJ
- Selection of levels to be displayed
- Display of meter readings with or without check number

In addition, with meters featuring solar adaption:

- Proportion of glycol or brine

The meter is supplied complete with an optical close-range interface as standard.

Add-on modules



The following external communication modules are available:

- M-bus module WFZ51
- AMR RF module WFZ56.OK/WFZ56.OF
- Walk-by RF module WFZ566.OK/WFZ566.OF

To parameterize the RF add-on module, the ACT20 software can be used.

M-bus module WFZ51



Function description

The M-bus module (WFZ51) enables the meter to communicate with an M-bus central communication unit to transmit the measured values.

Readout parameters

The following parameters are read out via the M-bus interface:

- Device number (8 digits)
- Medium/software version
- Time of day/date
- Error state (readout 5 or 45 times a day)
- Error date
- Current consumption values (heat or cooling energy, volume)
- Date of due day
- Due day value (heat or cooling energy)

The following data are optional or can be called up via application selection (conforming to EN 13757-3 or supplier-specific):

- 13 monthly values (heat or cooling energy)
- Flow rate
- Power
- Energy
- Flow/return temperature

**AMR RF module
WFZ56.OK/WFZ56.OF**



Function description

The meters are read out via radio with the help of the AMR add-on modules (WFZ56.OK and WFZ56.OF). The modules send cyclically the current consumption data to the network nodes. These collect automatically the data of all connected meters and store them. The customer can then read out all consumption data of a plant from a remote location.

The add-on module is available in 2 versions:

- WFZ56.OK with integrated antenna
- WFZ56.OF with external antenna

Readout parameters

The meter forwards the following parameters via radio:

- Device number (8 digits)
- Medium/software version
- Time of day/date
- Error state
- Error date
- Current consumption
- Date of due day
- Due day value
- 13 monthly values

**Walk-by RF module
WFZ566.OK
WFZ566.OF**



Function description

The meters are read out locally via radio with the help of the walk-by add-on modules (WFZ566.OK and WFZ566.OF). They forward the consumption data at preset times. Using the mobile data collector (WTZ.MB) and a PC with associated software, the person making the reading collects the radio telegrams. To do this, there is no need to enter the user's apartment or office. In the case of smaller plants, the data can usually be collected from outside the building.

The add-on module is available in 2 versions:

- WFZ566.OK with integrated antenna
- WFZ566.OF with external antenna

The meter forwards the following parameters via radio:

- Device number (8 digits)
- Medium/software version
- Time of day/date
- Error state
- Error date
- Current consumption
- Date of due day
- Due day value
- 13 monthly valves

The RF add-on modules WFZ566.OF and WFZ566.OK come with the following settings:

- Type of readout
 - Annually = 48 readout days once per year after the due date

- Transmission period

Setting of the time of day for the start or the end of the transmission of radio telegrams. The daily transmission period of the device is 10 hours (default = 8:00 a.m. – 6:00 p.m. CET)

- Transmission delay (offset)

Time delay of the transmission of telegrams after the due date or the start of the month in days (default = 0 days)

- Transmission-free days

A maximum of 2 weekdays – selected from Friday, Saturday and Sunday – can be defined as transmission-free days. At least 1 weekday must be set (standard = Sunday)

Display

Type of processor

The LCD shows meter states, display units and consumption values on several levels.

The meter has 2 buttons to switch between the individual display steps and levels.

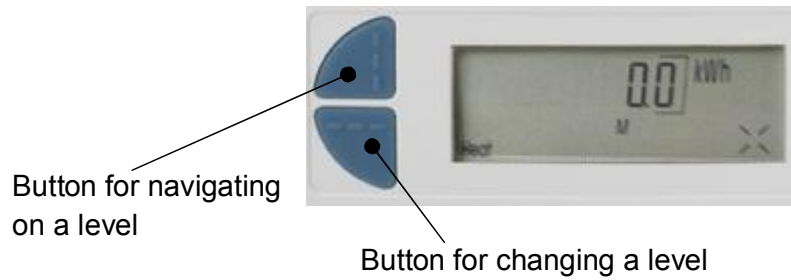

Operation

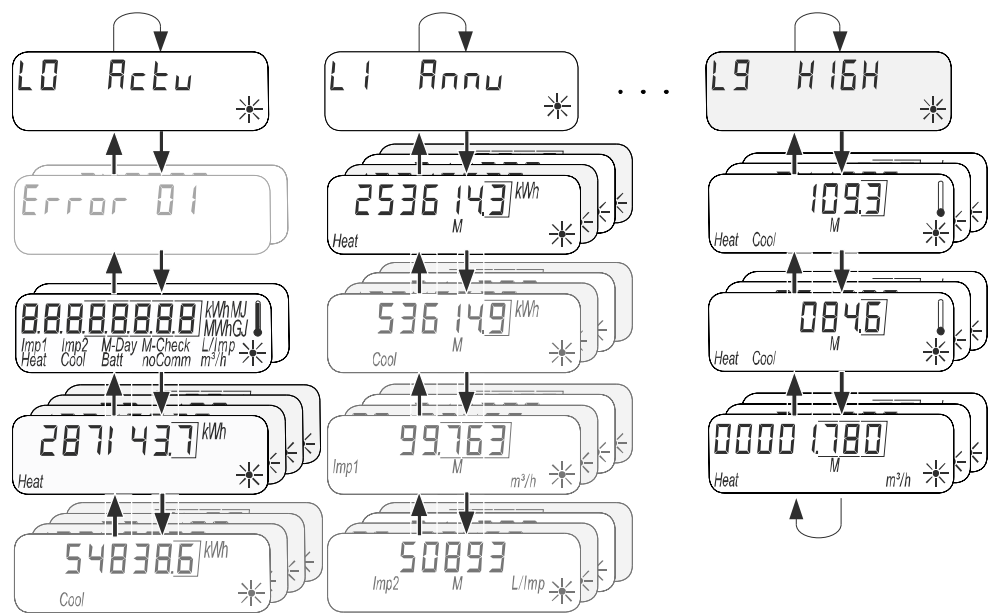

Quick reading mode

The meter's display is in sleep mode ☾ during operation and activated only when a button is pressed. A single short press of a button repeats the quick read loop 10x. At the end of 10 repetitions, the display returns to sleep mode ☾.

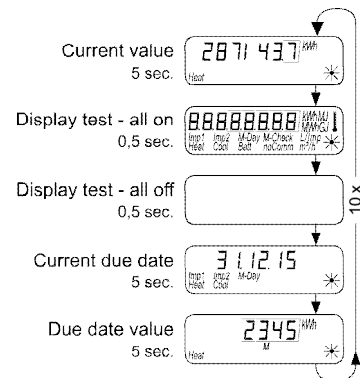

The quick read loop can be cancelled at any time by pressing a button > 3 s.

The display automatically goes to the standard display levels.

Error messages

For a serious fault, the error code and error date is displayed in front of the meter state display.

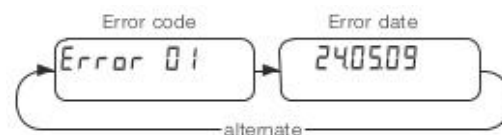

The meter state display displays "incorrect flow direction" if determines the flow direction is wrong:

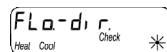

Display levels

The following levels are available:

- Standard levels:
 - L0 Current consumption values
 - L1 Annual consumption values
- The following levels can be deactivated individually:
 - L2 Current values
 - L3 Parameters
 - L4 Connections
 - L5 Monthly values heat
 - L6 Monthly values cooling energy
 - L9 Maximum values

If an error message is pending, it is logged with the respective error code plus the date the error occurred and shown on the display (alternating).

Level L0 Current consumption values

Displays the level
 Displaytest – all on
 Display test – all off

Error code
 Error date

Current consumption values

These segment blocks depend on the device configuration

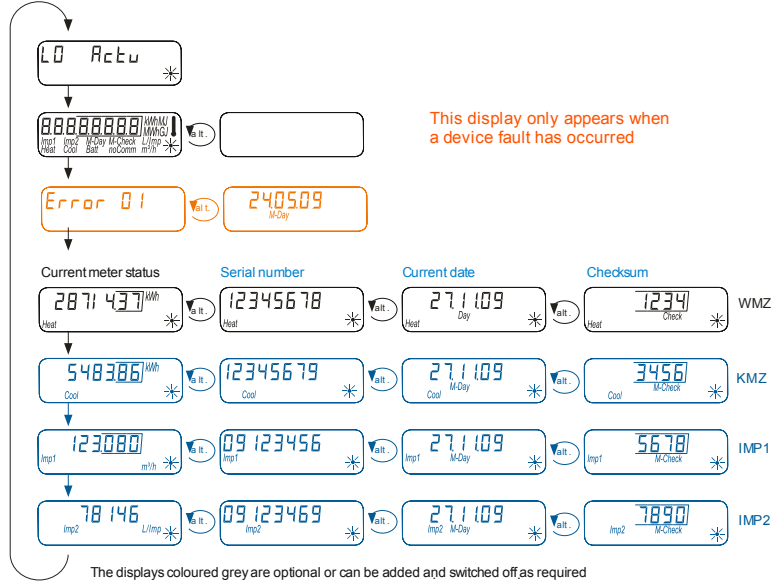

This display only appears when a device fault has occurred

The displays coloured grey are optional or can be added and switched off as required

Level L1 Annual consumption values

Displays the level

Annual consumption values

These segment blocks depend on the device configuration.

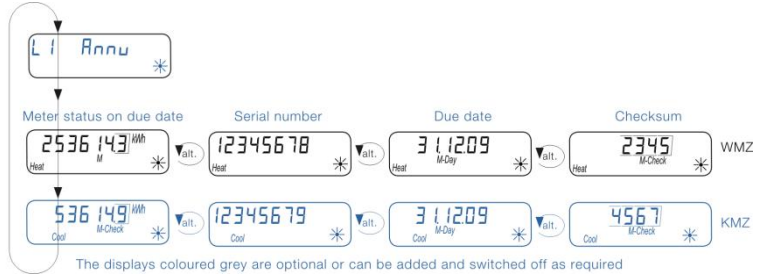

The displays coloured grey are optional or can be added and switched off as required

**Level L2
Current values**

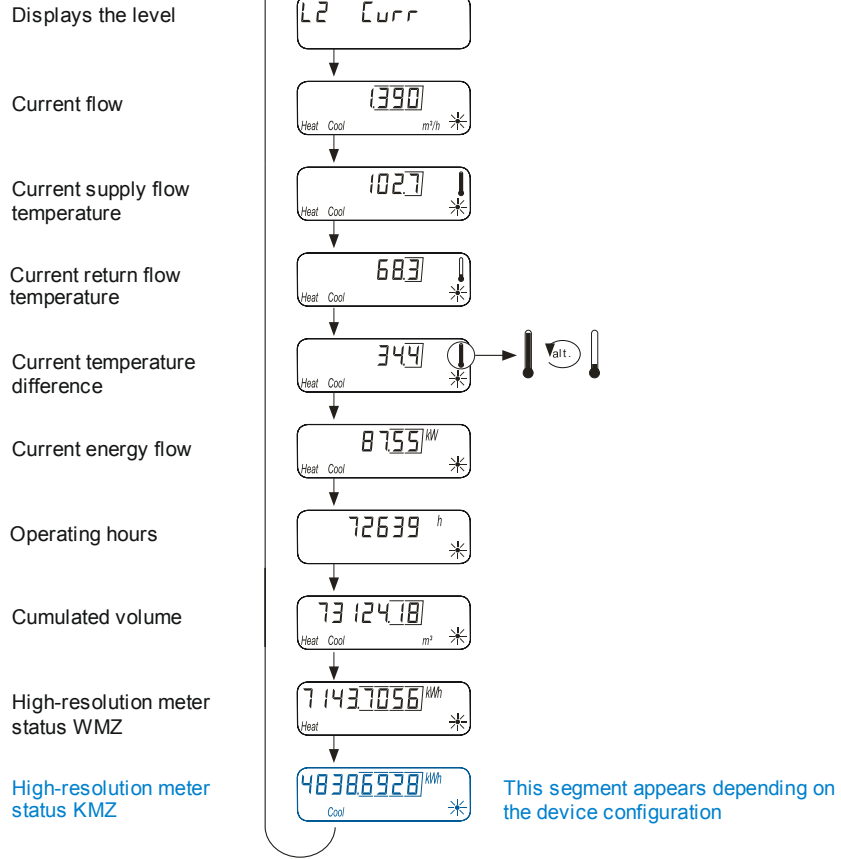

**Level L3
Parameters**

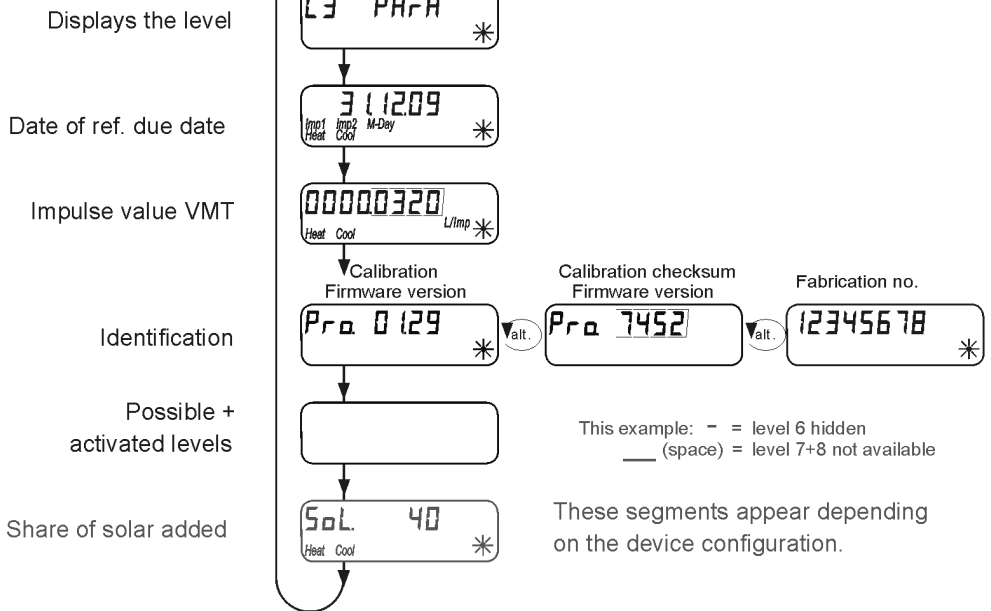

**Level L4
Connections**

These segment blocks appear depending on the meter's configuration.

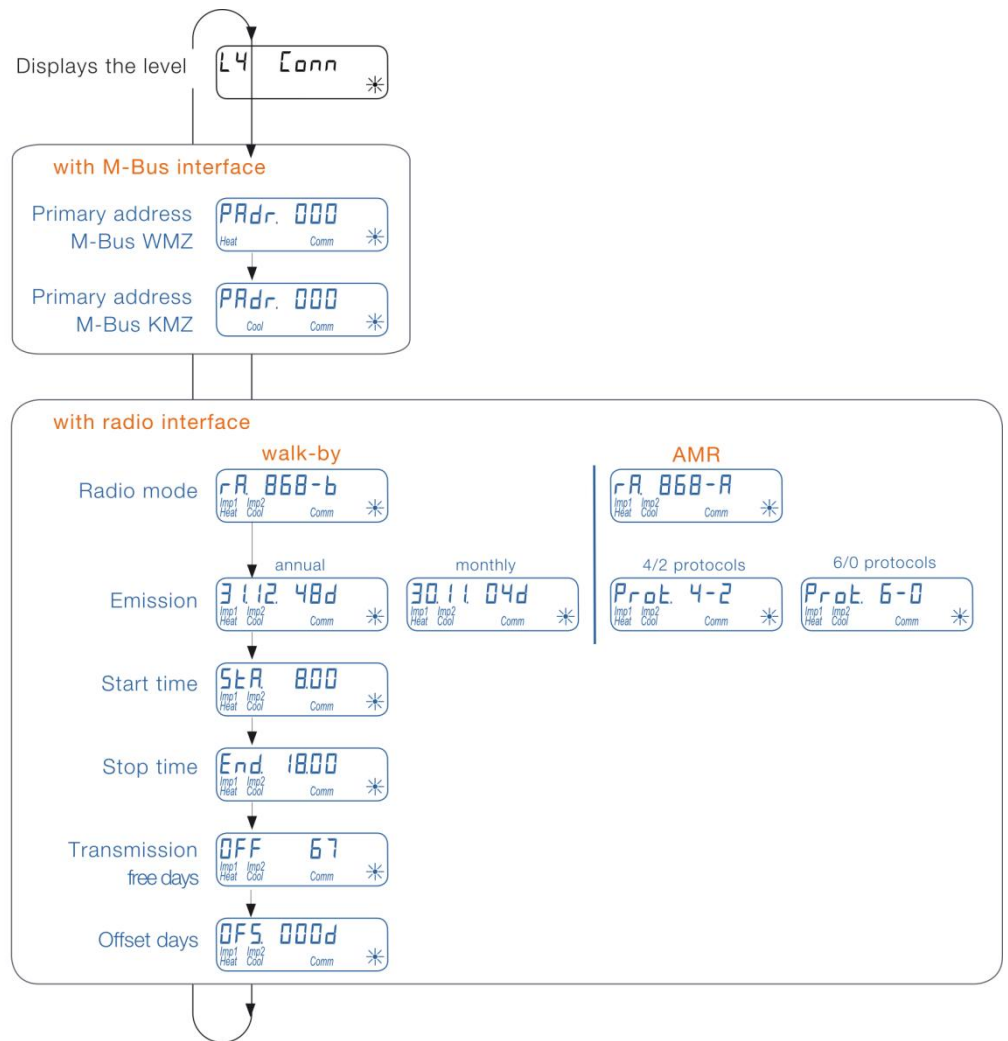

Level L5 Monthly values heat

This level is displayed only when the meter is configured for metering heat.

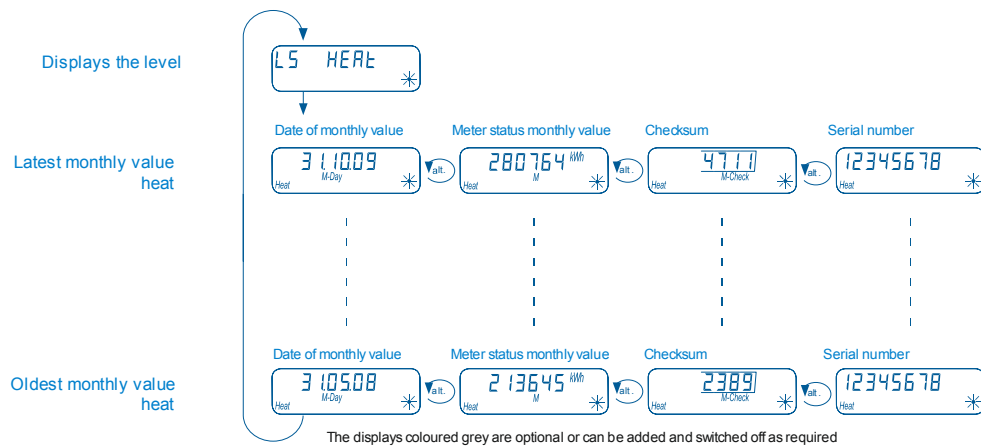

Level L6 Monthly values cooling energy

This level is displayed only when the meter is configured for metering cooling energy.

This level is only displayed when the device has been configured for cold metering.

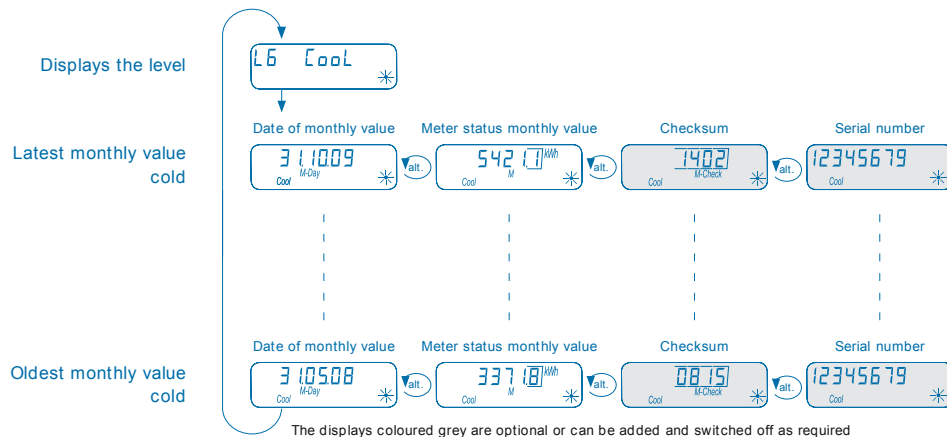

**Level L9
Maximum values**

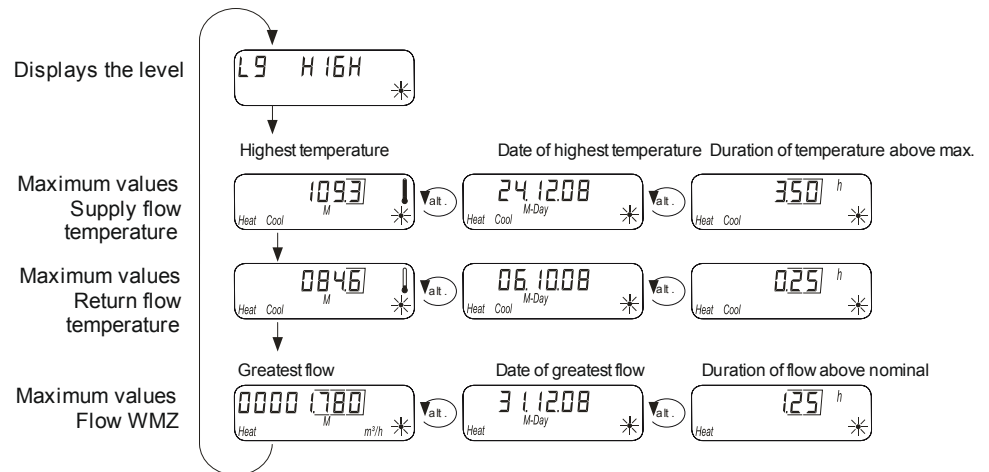

Error messages

Indication of errors	Description of error	Measures/notes
Error 01 *	Hardware error or damaged software	Check flow sensor, connecting cable and processor for signs of external damage Exchange the device
Error 06 *	Flow sensor is broken	Check temperature sensor and wires for mechanical damage Exchange the device
Error 07 *	Flow sensor short circuit	Check temperature sensor and wires for mechanical damage Exchange the device
Error 08 *	Return sensor is broken	Check temperature sensor and wires for mechanical damage Exchange the device
Error 09 *	Return sensor short circuit	Check temperature sensor and wires for mechanical damage Exchange the device

Mounting notes

Flow measuring section

The meter's mounting position is optional (with the exception of upside down). The mounting location (return or flow) depends on the type of meter. Settling paths are not required, neither upstream of nor downstream from the meter. But if the meter is installed in the common return of 2 heating circuits (e.g. space heating and DHW), a certain distance to the joining T-piece (min. $10 \times \text{DN}$) must be observed to make certain the water is properly mixed.

Before installing the meter, the system must be thoroughly flushed.

The flow measuring section must be installed between 2 shutoff valves, and the arrow on the measuring section must agree with the direction of flow. The temperature sensors must be installed in the same water circuit as the flow measuring section (observe mixing). Depending on their design, the sensors can be fitted in T-pieces or ball valves. They can be directly immersed or fitted in immersion pockets (observe national regulations). In any case, the sensors' minimum immersion length must be such that their ends reach the pipe's center. Sensors and screwed connections must be sealed to prevent tampering.

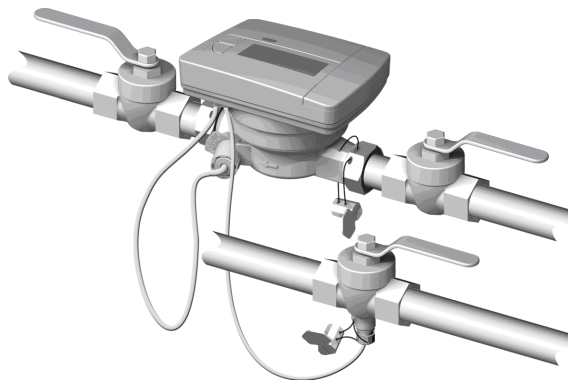

Mounting with ball valves

Processor

Basic design of processor:

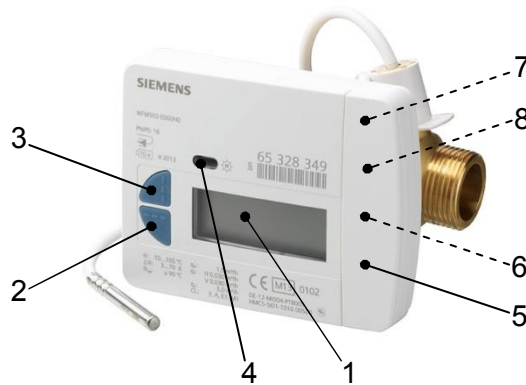

- 1 LCD
- 2 Button to change between the levels
- 3 Button to navigate on a level
- 4 IrDA interface
- 5 Interface cover
- 6 Module interface
- 7 Fixing holes for external add-on modules
- 8 User protection and sockets for external cable connections

The processor's ambient temperature of 55 °C must be observed. Direct solar radiation must be avoided.

Depending on the version (compact or removable meter), the processor can be removed from the flow measuring section to be fitted on the wall with the mounting bracket at a distance of 40 cm.

Add-on modules

The external add-on module (WFZ..) can be fitted to any meter. To do this, proceed as follows:

- a) Remove interface cover from the meter
- b) Fit add-on module and secure it

Shortly after fitting, the add-on module identifies automatically the type of meter and makes the required alignment (series number, monthly values, due day, current value and type of medium).

The modules are parameterized with the ACT20 software.

Wireless operation is activated via the WFZ-PS radio telegram tool or the ACT20 software.

Since the M-bus module adopts all parameters from the meter, only the primary address can be parameterized via the M-bus system.

The power required for operation is supplied by the M-bus system, but the module is equipped with a battery. It powers the module when there is no power available from the M-bus.

The modules do not affect the acquisition of consumption data and, for this reason, can be retrofitted at any time **without damaging the seal**.

Sealing

After mounting the meter, all components must be sealed to prevent tampering (observe national regulations):

- The flow measuring section with its fitting (inlet)
- The flow temperature sensor with the ball valve or the immersion pocket, the immersion pocket with the pipe and, if required,
- The module with the processor

Maintenance notes

Maintenance

The meters are maintenance-free. Observe national calibration regulations.

Disposal



The devices are considered electronics devices for disposal in terms of European Directive 2012/19/EU and may not be disposed of as domestic waste.

- Dispose of the device via the channels provided for this purpose.
- Comply with all local and currently applicable laws and regulations.
- Dispose of empty batteries at designated collection points.

Warranty

User-related technical data are only guaranteed in connection with the products listed in this Data Sheet.

If the meter is used in connection with third-party devices not explicitly mentioned, correct functioning must be guaranteed by the user. In such cases, Siemens does not provide any field or warranty services.

Technical data

Processor Power supply	Battery type	Lithium battery CR AA (cannot be replaced)			
	Battery voltage	3.0 V			
	Battery life	10 years with backup			
Function data	Measuring range				
	- Heat meter	15 ... 105 °C			
	- Heat meter with optional cooling range	Cooling range: 0.2 ... 24 °C			
	Differential temperature range $\Delta\Theta$	3...70 K			
	Threshold value				
Temperature sensor	- Heat	1.0 K			
	- Cooling energy	0.2 K			
	Thermal coefficient	Shifting compensated			
	Sensing element	Pt1000 as per EN 60751			
	Type	DS (direct short)			
Display	Diameter	Dia. 5.0 x 45 mm (standard)			
	Cable length	1.5 m (standard, 3 m optional)			
	Display	8-digit LCD + pictograms			
Communication	Energy display	kWh Optional: MWh/MJ/GJ			
	Optical interface				
	Design Protocol	Similar to EN 62056-21 Similar to EN 13757-2/3			
Flow measuring section impeller type meter	Temperature range (national approvals may differ)	10...90 °C			
	Max. temperature t_{max} .	90 °C			
	Rated pressure	1.6 MPa (PN 16)			
	Rated flow q_p m ³ /h	0.6	1.5	1.5	2.5
	Mounting length mm	110	80	110	130
	Connecting thread	G ¾ B"	G ¾ B"	G ¾ B"	G 1 B"
	Metrological class				
	- Horizontal	1:50	1:50	1:50	1:50
	- Vertical	1:25	1:50	1:50	1:50
	Max. flow rate q_s m ³ /h	1.2	3.0	3.0	5.0
	Min. flow rate q_i				
	- Horizontal l/h	12	30	30	50
	- Vertical l/h	24	30	30	50
	Response threshold l/h	3...4	4...5	4...5	6...7
	Pressure drop at q_p				
	Mounting length 80 mm Δp mbar	200			
	Mounting length 110 mm Δp mbar	200	200		
Mounting length 130 mm Δp mbar				180	
Flow rate at $\Delta p = 1$ bar, q_v m ³ /h	1.5	3.2	3.2	5.3	
Mounting position	Horizontal/vertical				

Communication

- M-bus add-on module WFZ51	M-bus slave interface	As per EN 1434-3 and EN 13757-2/-3	
	- Battery type	Lithium battery CR 2/3 AA	
	- Power supply	DC 3.0 V	
	- Standby current	≤1.5 mA	
	- Standard load	1.5 mA	
	- Addressing	Primary or secondary	
	- Baud rate	300, 2400 baud	
	- Polarity	Optional	
	- Galvanic separation	Per module interface	
	- Cable length	2.95 m	
	- Degree of protection	IP54	
	- Safety class	III	
	- AMR add-on module WFZ56.OK/WFZ56.OF	RF AMR	
- Battery type		Lithium battery CR 2/3 AA	
- Battery voltage		DC 3.0 V	
- Battery life		>11 years	
- Frequency		868.0...868.6 MHz	
- Norms		Data transmission as per EN 13757-4	
- Transmission power (typically)		5 dBm	
- Degree of protection		IP54	
- Safety class	III		
- Walk-by add-on module WFZ566.OK/WFZ566.OF	RF walk-by		
	- Battery type	Lithium battery CR 2/3 AA	
	- Battery voltage	DC 3.0 V	
	- Battery life	>11 years	
	- Frequency	868.0...868.6 MHz	
	- Norms	Data transmission as per EN 13757-4	
	- Transmission power (typically)	5 dBm	
	- Degree of protection	IP54	
- Safety class	III		
Protection of housing	Safety class	III	
	Degree of protection		
	- Processor	IP65	
	- Flow measuring section	IP65 as per EN 60529	

Environmental conditions

	Operation EN 60721-3-3	Transport EN 60721-3-2	Storage EN 60721-3-1
Climatic conditions	3K5	2K3	1K3
Temperature	5...55 °C	-25...70 °C	-5...45 °C
Humidity	<93% r.h. at 25 °C (non-condensing)	<93% r.h. at 25 °C (non-condensing)	<93% r.h. at 25 °C (non-condensing)
Mechanical conditions	3M2	2M2	1M2
Max. altitude	Min. 700 hPa (corresponding to max. 2000 m above sea level)		

Norms and standards	EU Conformity (CE)	
	- ALU	CE2T5323xx *)
	- RF module	CE2T5323xx01 *)
	- M-bus module	CE2T5323xx02 *)
	- Quality of heating medium	VDI guideline 2035
	- Type approval as per	- EN 1434-4 Ambient class A Measuring accuracy class 3
	Product standard	DIN EN 1434-1 (heat meters)
Environmental compatibility	The product environmental declaration CE1E5323en ^{*)} contains data on environmentally compatible product design and assessments (RoHS compliance, materials composition, packaging, environmental benefit, disposal).	
Dimensions	(W x H x D):	
	- Processor	101.5 x 78 mm
	- Flow measuring section	See "Dimensions"
Housing material	Processor	PC-ABS PC-LEXAN
	Processor	RAL 9016
Weight	Meter packed complete with accessories	0.6 m ³ /h: 928 g
		1.5 m ³ /h: 915 g
		2.5 m ³ /h: 1014 g

*) The documents can be downloaded from <http://siemens.com/bt/download>.

Dimensions

Screwed type meter

Mounting length 80 mm

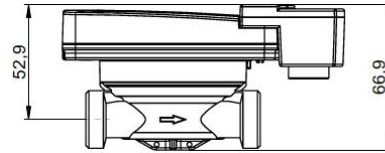

Dimensions in mm

Mounting length 110 mm

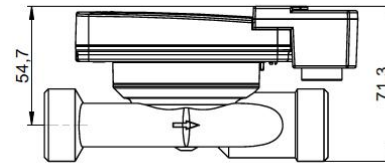
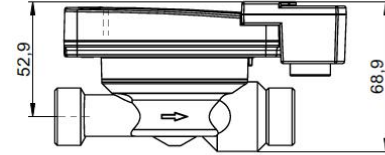

Mounting length 130 mm

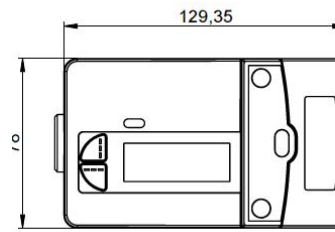

RF add-on module

Dimensions in mm

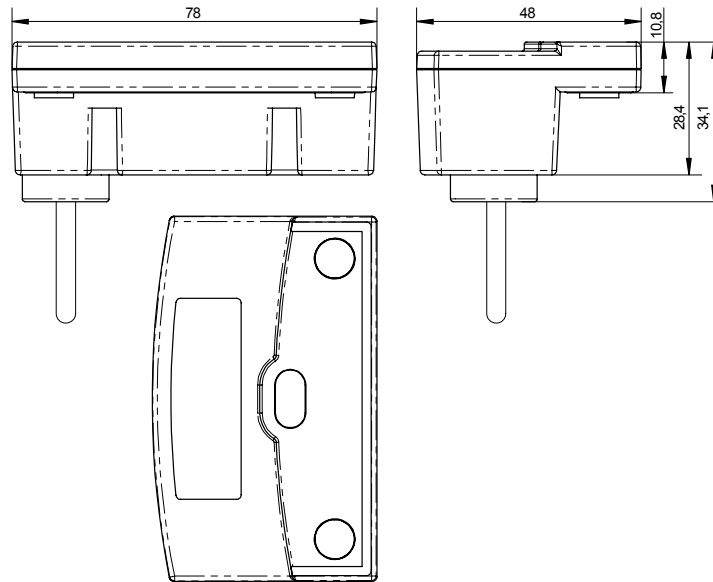

Published by:
Siemens Switzerland Ltd.
Building Technologies Division
International Headquarters
Gubelstrasse 22
6301 Zug
Switzerland
Tel. +41 41-724 24 24
www.siemens.com/buildingtechnologies

© Siemens Switzerland Ltd 2014
Delivery and technical specifications subject to change