

## RWD68



## Application

The universal controller is used for comfort control in HVAC systems. One digital output for 1 stage of on/off control and one analogue output with voltage from 0 to 10 V dc are provided. The main analogue input can be set as °C, °F, % or no specified unit.

The second analogue input can be used for the following applications:

- PI Limiter function ( absolute and relative limit)
- Remote setpoint function
- Setpoint compensation
- Winter / summer mode changeover ( analogue or digital input ) (reversal of heating / cooling output)
- Cascade control function
- Maximum priority for cooling/dehumidifying

The separate digital input is provided for day/night mode changeover.











The RWD68 controller is intended for either DIN rail mounting in a switchboard or screw mounting with protective enclosure.

Desired output configuration and auxiliary function must be entered for initial setup. Refer to Service (PS) mode sequence.

Application No. Summary									
(H = Heating, C = Cooling, R = Reverse Acting, D = Direct Acting) (The 1st digit = Main Control Loop, The 2nd digit = Auxiliary Control Loop)	Main Loop								
		#1x H or R sequence	#2x H+H or R+R depend.	#3x H+H or R+R independ.	#4x Dig H + ana C or Dig R + ana D	#5x Ana H + dig C or ana R + dig D	#6x C+C or D+D depend.	#7x C+C or D+D independ.	#8x C or D sequence
Auxiliary Loop									
#x0 No auxiliary	#10	#20	#30	#40	#50	#60	#70	#80	
#x1 Remote Setpt	#11	#21	#31	#41	#51	#61	#71	#81	
#x2 Absolute limiter	#12	#22	#32	#42	#52	#62	#72	#82	
#x3 Relative limiter	#13	#23	#33	#43	#53	#63	#73	#83	
#x4 Compensation shift	#14	#24	#34	#44	#54	#64	#74	#84	
#x5 Cascade	-	#25	#35	#45	#55	#65	#75	-	
#x6 Win/Sum digital	#16	-	#36	#46	#56	-	-	-	
#x7 Win/Sum analog	#17	-	#37	#47	#57	-	-	-	
#x8 Max. priority	-	-	-	#48	-	#68	#78	-	
#x9 Main loop (active input)	#19	#29	#39	#49	#59	#69	#79	#89	





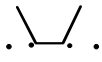

**Note:** Application sheets for the listed applications are available from your local supplier.  
e.g. RWD68 application 40, quote RWD68/40

## Display explanation

Name	Description	Display, Setting Range	Name	Description	Display, Setting Range
<b>General Screen</b>					
	Adjustable setpoint page				
#10	Application No	10...89 (Not consecutive numbers)	TOOL	PC communication port being used	
	Day time operation				
	Night time operation				
X1	Universal (Main) Input X1	<ul style="list-style-type: none"> <li>Ni 1000Ω: -50...150°C (unchangeable)</li> <li>Pt 1000Ω: -20...180°C (unchangeable)</li> <li>0-10 Vdc: -100...8000</li> </ul>	OUT RANGE	The setting is out of range	
X2	Universal (Auxiliary) Input X2	<ul style="list-style-type: none"> <li>Ni 1000Ω: -50...150°C (unchangeable)</li> <li>Pt 1000Ω: -20...180°C (unchangeable)</li> <li>0-10 Vdc: -100...8000</li> <li>Variable resistor: the resistance range should within 0...1000 Ω</li> </ul>	Err	Sensors error	
Q1	Digital output	■ is on; is off	#10 *	★ = Using not the defaulted sensor	
Y1	Analogue output	0.0...10.0 Vdc		Winter/Summer mode being chosen or activated	
On	On status				
Off	Off status				
°C	Celsius scale				
°F	Fahrenheit scale				
K	Kelvin				
%	Percentage scale (e.g. RH)				
----	No unit (e.g. pressure, air quality and air volume flow)				
Sec	Second				
				Limiter mode being chosen or activated	
				Remote setpoint mode being chosen or activated	
				Setpoint compensation mode being chosen or activated	
				Cascade mode being chosen or activated	
				Maximum priority mode being chosen or activated	
			SP-h	Setpoint on the heating side for temperature control	
			SP-c	Setpoint on the cooling side for temperature control	
			SP-r	Setpoint on the reverse acting side for active input (0...10 Vdc)	
			SP-d	Setpoint on the direct acting side for active input (0...10 Vdc)	
			XDZ	<ul style="list-style-type: none"> <li>For R or D independent loops. Day setpoint offset from the first output to the second output when in  mode.</li> <li>For R+D application. Dead zone between R and D day setpoints when in  mode.</li> </ul>	
				<ul style="list-style-type: none"> <li>Ni: 0.5...180 K</li> <li>Pt: 0.5...180 K</li> <li>Active input: 0.05...7300</li> </ul>	

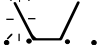
Name	Description	Display, Setting Range	Name	Description	Display, Setting Range
<b>Programming Screen</b>					
PS 1	Parameter Setting Mode: Application No. Setup		PS 4	Parameter Setting Mode: Main Control Loop Setting	
PS 2	Parameter Setting Mode: Defining Unit, X1 and X2		PS Next	To enter the next Parameter Setting	
PS 3	Parameter Setting Mode: Auxiliary Control		PS Exit	To exit the whole Parameter Setting Mode	
<b>PS 4 - Main Control Loop Setup</b>					
T1	Minimum switch off time for Q1	0...255 sec	SD	Switching Differential	0.05...7300
TN	Integral action time for Y1	0...4096 sec	MIN	Output end point for Y1	0...100%
XP	Proportion band for Y1	0.05...7300 (Depends on the X1 setting range)	MAX	Output end point for Y1	MIN...100% or 0%...MIN
<b>PS 3 - Auxiliary Control Loop Setup</b>					
XP-h	Proportion band for heating	Ni: 0.5...180 K Pt: 0.5...180 K Active input: 0.05...7300		Compensation shift (Start point, End point & Shift differential)	
XP-c	Proportion band for cooling	Ni: 0.5...180 K Pt: 0.5...180 K Active input: 0.05...7300	T	Time elapsed to allow next winter/summer changeover (Y1 only for no. 36, 37, 56 and 57; Q1 only for no. 16, 17, 46 and 47)	0...4096 sec
XP-r	Proportion band for reverse acting	Active input: 0.05...7300	MAX	Maximum Limiter	-80...8000
XP-d	Proportion band for direct acting	Active input: 0.05...7300	MIN	Minimum Limiter	-100...7980
TN-h	Integral action time for heating	0...4096 sec	WIN	Winter changeover point	-100...8000
TN-c	Integral action time for cooling	0...4096 sec	SUM	Summer changeover point	-100...8000
TN-r	Integral action time for reverse acting	0...4096 sec			
TN-d	Integral action time for direct acting	0...4096 sec			
<b>PS 2 - Unit, X1 &amp; X2 sensor type and sensing range definition</b>					
UNT	Unit define	°C, °F, % or ----(no unit display)	ΔX1	Calibration offset for X1 (Ni & Pt sensor only)	-5...5 K or -9°F...9°F
X1LS	X1 is Landis & Staefa Ni 1000Ω temperature sensor	Ni 1000Ω: -50...150°C (unchangeable)	ΔX2	Calibration offset for X2 (Ni & Pt sensor only)	-5...5 K or -9°F...9°F
X2LS	X2 is Landis & Staefa Ni 1000Ω temperature sensor	Ni 1000Ω: -50...150°C (unchangeable)	X1 L	Start point of the X1 (for 0-10 Vdc only)	-100...8000
X1Pt	X1 is Platinum Pt 1000Ω temperature sensor	Pt 1000Ω: -20...180°C (unchangeable)	X2 L	Start point of the X2 (for 0-10 Vdc only)	-100...8000
X2Pt	X2 is Platinum Pt 1000Ω temperature sensor	Pt 1000Ω: -20...180°C (unchangeable)	X1 H	Stop point of the X1 (for 0-10 Vdc only)	-100...8000
X1 0-10	X1 is 0-10 Vdc input sensor	0-10 Vdc: -100...8000	X2 H	Stop point of the X2 (for 0-10 Vdc only)	-100...8000
X2 0-10	X2 is 0-10 Vdc input sensor	0-10 Vdc: -100...8000	X2VR	Variable Resistor	0...1000 Ω
<b>PS 1 - Application No. Selection:</b>					
<b>LIM</b>	Absolute Limiter		<b>LIM</b>	Relative Limiter	
ABS			rEL		
<b>WIN/SUM</b>	Winter/Summer changeover by digital input		<b>WIN/SUM</b>	Winter/Summer changeover by analogue input	
diG			AnLG		
Act	Active sensor input				

## PS 3 Auxiliary function parameter setup





Parameter	Description	Auxiliary number:						
		#x1 REM	#x2 LIM	#x3 LIM	#x4 COMP	#x5 CAS	#x6 WIN/SUM	#x7 WIN/SUM
XDZ	Dead zone or offset (refer to the above explanation)	x						
MAX	the value to start Limiter heating/direct acting		x	x				
MIN	the value to start Limiter heating/reverse acting		x	x				
XP-h / -r	the P-band in Limiter heating/reverse acting		x	x				
XP-c / -d	the P-band in Limiter cooling/direct acting		x	x				
TN-h / -r	integrating time heating/reverse acting		x	x		x		
TN-c / -d	integrating time cooling/direct acting		x	x		x		
	COMP start point heating/reverse acting				x			
	COMP end point heating/reverse acting				x			
	adjustment in heating/reverse acting				x			
	COMP start point cooling/direct acting				x			
	COMP end point cooling/direct acting				x			
	adjustment in cooling/direct acting				x			
MAX	maximum of virtual setpoint					x		
MIN	minimum of virtual setpoint					x		
XPh1 / r1	1st heating/reverse acting P-band in Cascade					x		
XPc1 / d1	1st cooling/direct acting P-band in Cascade					x		
WIN	As $X2 < WIN$ , Y1(or Q1, depends on application no.) is reverse acting							x
SUM	As $X2 > SUM$ , Y1(or Q1 depends on application no.) is direct acting							x
T	Time elapsed to allow next winter/summer changeover						x	x

There are no PS3 auxiliary function parameters for applications #8 and #9.

## Operating Modes

The controller has three operating buttons for the following functions:

SELECT ● The SELECT ● button is used to enter or save the value adjustment.

  The   operating buttons are used for viewing and adjusting parameters.

## Time-out

For setpoint adjustment in Normal mode, the controller will exit the setting after 20 seconds automatically. However, for setpoint adjustment in Service (PS) mode, there is no time limit. The controller remains on the PS mode until the user completes the whole process.

## Note

Only those parameters that apply to a particular program appear on the display or in the sequence in programming.



For example, if the second analogue input is not used, X2 values and selections will not appear.

A software tool (S3341A031EN0) for controller application selection and parameter adjustment is available. It is a user-friendly Windows® 95 (or above) based software tool which provides you a printout of the controller settings.





Parameters can be hidden from display if desired by using the software tool.

## Main Display











The main display shows ,

- (a) Whether Q1 is On or Off (  = off,  = on )
- (b) Y1 output in Volts dc. (0 to 10V will be display as 0, 1, 2...10)
- (c) Whether day or night set point is selected. (☼ = day, ☾ = night)
- (d) X1 value in °C, °F, % or no unit.

Other displays are available by pressing the “+” button, and the various displays are listed below in sequence from the main display.

On entering any of the four set point displays, the setpoint on display can be adjusted by pushing the  enter/save button, increase value by pressing the  “+” button or decrease the value by pressing the  “-” button, and when the required value is reached, press the  enter/save button to save the new value.

The alternative displays return to the main display after 20 seconds duration.



Press buttons	Action	Typical Display	Selected display comments
---	---	Q1 Y1 X1 ☼	Default page includes: X1 reading, Q and/or Y output status Day/night setpoint selection status
	Push “+” button to enter next page	Q1 SP – h ☼ 19.0 °C	<b>Setpoint page, setting value displayed and is adjustable :</b> First stage heating or cooling , direct or reverse day acting setpoint, depending on application.
	Push “+” button to enter next page	Y1 SP – c ☼ 21.0 °C	<b>Setpoint page, setting value displayed and is adjustable :</b> Second stage heating or cooling , direct or reverse day acting setpoint, depending on application.
	Push “+” button to enter next page	Q1 SP – h ☾ 15.0 °C	<b>Setpoint page, setting value displayed and is adjustable :</b> First stage heating or cooling , direct or reverse night acting setpoint, depending on application
	Push “+” button to enter next page	Y1 SP – c ☾ 25.0 °C	<b>Setpoint page, setting value displayed and is adjustable :</b> Second stage heating or cooling , direct or reverse night acting setpoint, depending on application
	Push “+” button to enter next page	X1 20.0 °C	X1 – main sensor reading
	Push “+” button to enter next page	X2 10.0 °C	X2 – auxiliary sensor reading
	Push “+” button to enter next page	Q1 oFF	Output page: output status displayed First stage Q1 digital status - on or off [Depending on application]
	Push “+” button to enter next page	Y1 5.0	Output page: output value or status displayed Second stage Y1 value in Vdc [Depending on application]
	Push “+” button to enter next page	 #43	Application number and control sequence diagram.
	After 20 seconds any page will return to the main default page if left unattended.	Q1 Y1 X1 ☼	Back to main default page

## Service (PS) Mode screen sequence

Press  both buttons and hold them for 5 sec to enter the Service Mode.

Press  for viewing the next page OR to increase value.

Press  for viewing the previous page OR to decrease value.

Press  to enter the PS page OR edit and save the value when the page appears with the logo .

On entering service (PS) mode, PS4 appears first.

For initial setup, proceed directly to PS1 and enter your desired application number first.

PS1 will already be opened if power has never been connected to new controller. (Refer below \*)

PS2 to PS4 parameters may need to be adjusted for service/commissioning purposes.

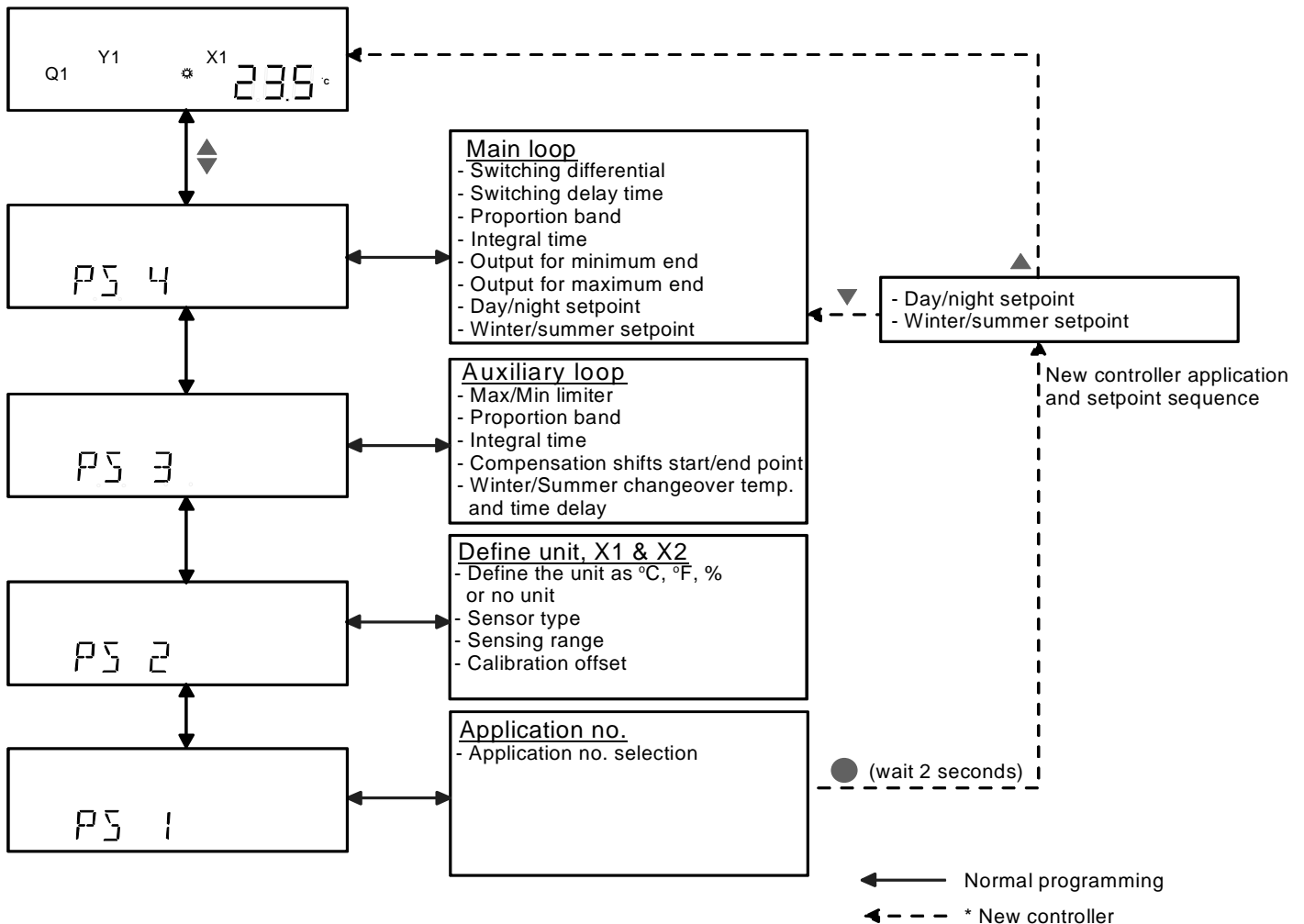

## Connection Diagram

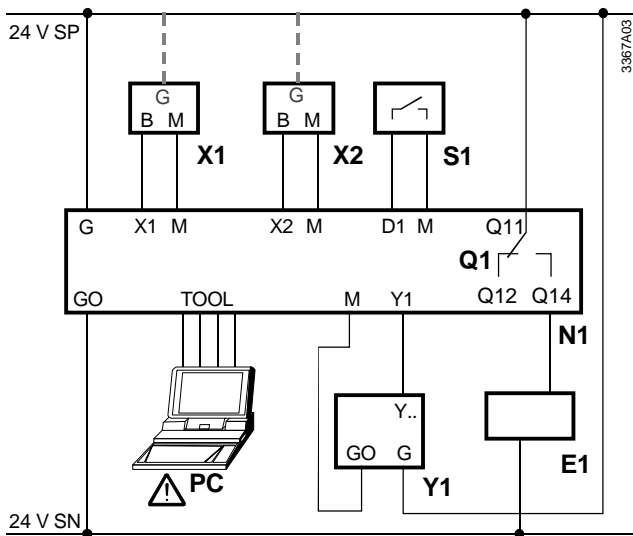

### RWD68

- N1 RWD68 controllers
- X1 Main temperature sensor (Termination G appears when X1 is an active sensor)
- X2 Auxiliary temperature sensor or remote setpoint (Termination G appears when X2 is an active sensor)
- S1 Time clock or switch
- Q1 Potential-free relay contacts for 2-position
- Y1 Valve actuator / damper actuator
- E1 Electrical load 2-position control
- PC Desktop or notebook computer

Note: Output relay contacts (potential free) can be supplied with AC 24 to 230 volts.

⚠ Please note that the TOOL signal ground is galvanically connected to G0 inside the controller. If the signal line of the computer is grounded to Earth, the G0 line after TOOL connection will be Earthed as well. This will change the SELV to a PELV.

## Internal Diagram / Terminals

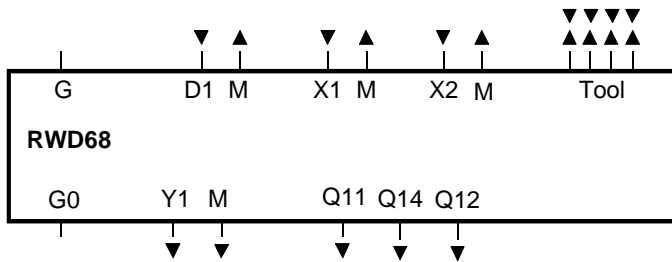

- G-G0 AC 24 V supply  
(⚠ SELV AC 24 V Power supply)
- M Ground (G0) for signal inputs and universal inputs
- X1 Signal input (main input: LS Ni 1000, Pt 1000 and 0 ...10 Vdc)
- X2 Signal input (aux. Input: LS Ni 1000, Pt 1000, 0 ...10 Vdc and remote setting unit)
- Y1 Analog outputs
- Q1.. Digital output, various voltages permissible
- D1 Digital input
- G0 Ground (G0) for signal outputs
- Tool communication port with PC (9-pin plug)

## Controller Dimensions

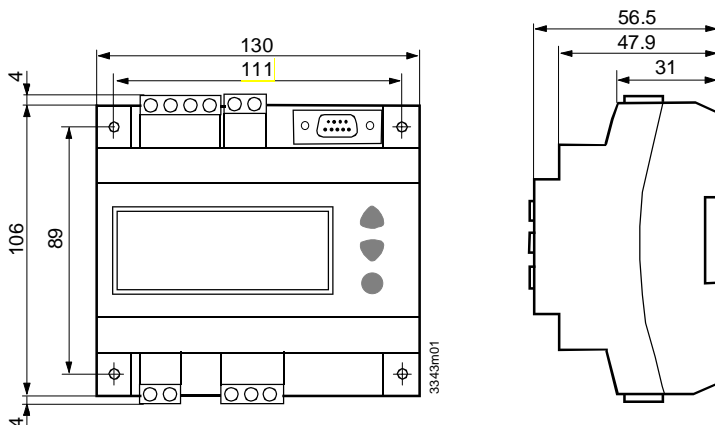



## Mounting Possibilities

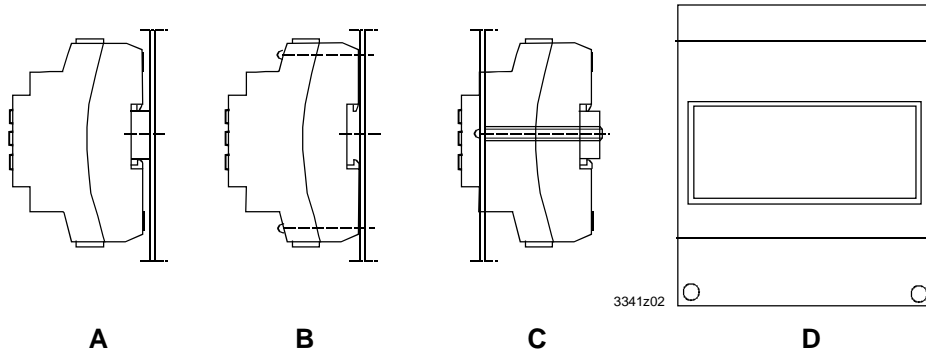

There are four possibilities for mounting the RWD68 controller

### Mounting Installation

The RWD68 controllers can be mounted as follows:  
Observe all local installation and mounting regulations.

- A On DIN rail (EN 50 022-35 x 7.5) at least 120 mm long
- B For wall mounting with 2 screws  
(Minimum length of the screw should be 40mm long( $\phi$ 3.2mm.)
- C Front mounted using standard elements  
e.g. 1x DIN rail 150 mm long,  
2 x hexagonal placeholders 50 mm, washers and screws  
(Ensure all terminations are tightened before final mounting to front panel)
- D Inside the ARG62.21/ARG62.22

**Note:** There must be a minimum of 8mm distance from terminations to panel/enclosures in order to avoid electric shock.

### Electrical installation

Standard cables can be used for the controller. However, when mounting in an environment greatly exposed to EMI, use only shielded cables.

- The RWD68 is designed for AC 24 V operating voltage.

The low voltage must comply with the requirements for safety extra-low voltage (SELV) as per EN 60730.

Use safety insulating transformers with double insulation as per EN 60742; they must be designed for 100 % on-time.

When using several transformers in one system, the connection terminals G0 must be galvanically connected.

Supplying voltages above AC 24 V to low voltage connections may damage or destroy the controller or any other connected devices. Additionally, connections to voltages exceeding AC 42 V endanger personal safety.

**Mounting Enclosure Dimensions**

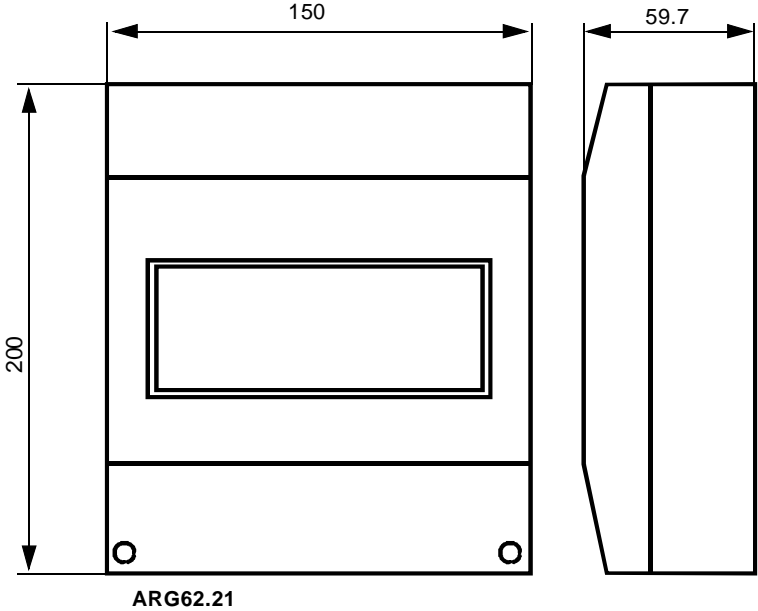

ARG62.21