



Presentation example PME7...

Presentation example LME7...

PME71.901...

Program module for burner control LME71.000

User Documentation

Application:

- Modulating, direct ignited forced draft burners
- Integrated PWM fan motor control via 3-position controller or analog signal for burners with pneumatic ratio control
- Integrated valve proving (can be parameterized)
- E.g. for burners to EN 676

The PME7... and this User Documentation are intended for use by OEMs which integrate the LME7... and PME7... in their products.



Note!

This documentation is only valid together with LME7... Basic Documentation (P7105)!

Contents

1	Supplementary documentation	3
2	Warning notes	4
3	Typographical conventions	4
4	Program sequence PME71.901.....	5
5	List of phase display	6
6	Fuel trains (examples)	7
6.1	Gas direct ignition (G), 1-stage	7
6.2	Gas direct ignition (G), 1-stage, with valve proving	7
7	Gas valve proving.....	8
8	Input gas pressure switch-min	10
9	Time table and settings	11
10	Inputs and outputs / internal connection diagram	13
11	Parameter list (AZL2...).....	14
12	PWM settings	19
12.1	Relevant parameters.....	19
12.2	PWM control parameters	21
12.3	PWM safety parameters	22
12.4	Initial PWM parameter settings.....	23
12.4.1	Initial settings of PWM basic parameters.....	23
12.4.2	Reading the value of parameter 920 in the prepurge phase (Ph30) and ignition load phase (Ph38, Ph40 and Ph44)	27
12.4.3	Final settings of PWM safety parameters	28
12.4.4	Setting safety parameters 675.00/675.01 and checking the safety settings under worst-case conditions	31
12.4.5	Matching the working points “Speeds for low-fire (P1), ignition load (P0) and high-fire (P2) for the heating engineer to the application	32
12.4.6	... via the onboard operating panel of the LME7... basic unit.....	33
12.4.7	... via the AZL2... operating unit.....	34
12.5	Overview of PWM fan parameters (value range refers to PME71.901).....	36
13	Error code list.....	38
14	Legend	40
15	List of figures	41

1 Supplementary documentation

Product type	Type of documentation	Documentation number
LME...	Environmental Product Declaration	E7105
PME...	Environmental Product Declaration	E7105.1
LME7...	Data Sheet	N7105
LME...	Product Range Overview	Q7010
LME7	Basic Documentation	P7105

2 Warning notes



Warning!

The safety, warning and technical notes given in the Basic Documentation on the LME7... (P7105) apply fully to the present document also!

To avoid injury to persons, damage to property or the environment, the following warning notes must be observed!

The LME7... are safety devices! Do not open, interfere with or modify the unit. Siemens does not assume responsibility for damage resulting from unauthorized interference!

When the fan operates on permanent phase, it must be ensured that there is a safe electrical separation between mains voltage and PWM/Hall input/output. If not observed, there is a risk that safety functions will be impaired and that a risk of electric shock will exist

3 Typographical conventions

Safety notes

This User Documentation contains notes which must be observed to ensure your personal safety and to protect the product and the connected equipment. The instructions and notes are highlighted by warning triangles-or a hand symbol and are presented as follows, depending on the hazard level:



Warning

means that death, severe personal injury or substantial damage to property **can** occur if adequate precautionary measures are not taken



Note

draws your attention to **important information** on the product, on product handling, or to a special part of the documentation

Qualified personnel

Only **qualified staff** are allowed to install and operate the equipment. Qualified staff in the context of the safety-related notes contained in this document are persons who are authorized to commission, ground and tag devices, systems and electrical circuits in compliance with established safety practices and standards.

Correct use

Note the following:

The device may only be used on the applications described in the technical documentation and only in connection with devices or components from other suppliers that have been approved or recommended by Siemens.

The product can only function correctly and safely if shipped, stored, set up and installed correctly, and operated and maintained as specified.

4 Program sequence PME71.901...

→ For fuel trains G without/with valve proving

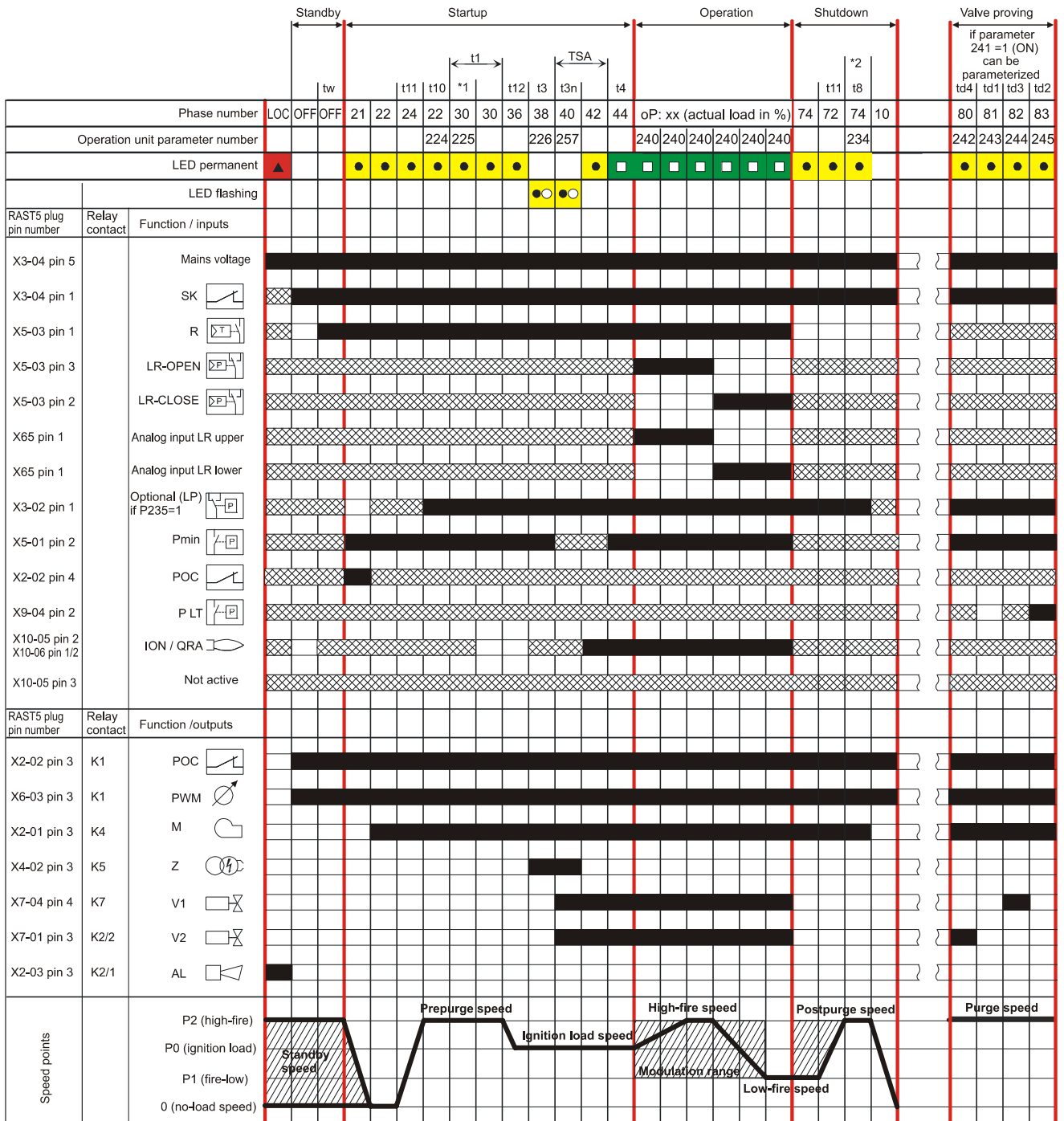

Figure 1: Program sequence

7105d71e/0312

5 List of phase display

Phase number of display 7-segment AZL2...		LED	Function
LOC	LOC	OFF	Lockout phase
Standby			
OFF	OFF	OFF	Standby, waiting for heat request
P08	Ph08	OFF	Power ON/test phase (e.g. detector test)
Startup			
P21	Ph21	Yellow	Safety valve ON, air pressure switch in no-load position Test if POC closed (timeout/lockout after 5 seconds) Fan motor speed reduced to 0
P22	Ph22	Yellow	Part 1: Fan motor ON Part 2: Specified time air pressure switch Message (timeout), stabilization air pressure switch
P24	Ph24	Yellow	Stabilization time, fan motor - prepurge speed
P30	Ph30	Yellow	Part 1: Prepurge time without extraneous light test *1 Part 2: Prepurging with extraneous light test (2.1 seconds)
P36	Ph36	Yellow	Speed stabilization time, fan motor ignition load speed
P38	Ph38	Yellow flashing	Preignition time
P40	Ph40	Yellow flashing	Postignition time
P42	Ph42	Green	Flame detection
P44	Ph44	Green	Interval: End of safety time and load controller release
Operation			
xx	oP:xx	Green	Operation (modulation), display of actual value in percent (%)
Shutdown			
P10	Ph10	OFF	Home run
P72	Ph72	Yellow	Speed stabilization time, fan motor postpurge speed
P74	Ph74	Yellow	Postpurge time *2
Valve proving			
P80	Ph80	Yellow	Test space evacuating
P81	Ph81	Yellow	Test atmospheric pressure
P82	Ph82	Yellow	Test space filling
P83	Ph83	Yellow	Test gas pressure
Safety shutdown phases			
P01	Ph01	Yellow / red	Under voltage / over voltage
P02	Ph02	Yellow	Safety shutdown (e.g. open safety loop) → lockout
P04	Ph04	Green / red	Extraneous light in standby
P90	Ph90	Yellow	Gas pressure switch-min open → safety shutdown and start prevention

*1 Valve proving during prepurging, if
 - parameter 241.00 = 1 and parameter 241.02 = 1 or
 - parameter 241.00 = 1 and parameter 241.01 = 0 or
 - parameter 234 (postpurge time) = 0 seconds

*2 Valve proving during postpurging, if
 - parameter 241.00 = 1 and parameter 241.02 = 1 or
 - parameter 241.00 = 1 and parameter 241.01 = 1 and
 - parameter 234 (postpurge time) >0 seconds

6 Fuel trains (examples)

6.1 Gas direct ignition (G), 1-stage

LME71.000...

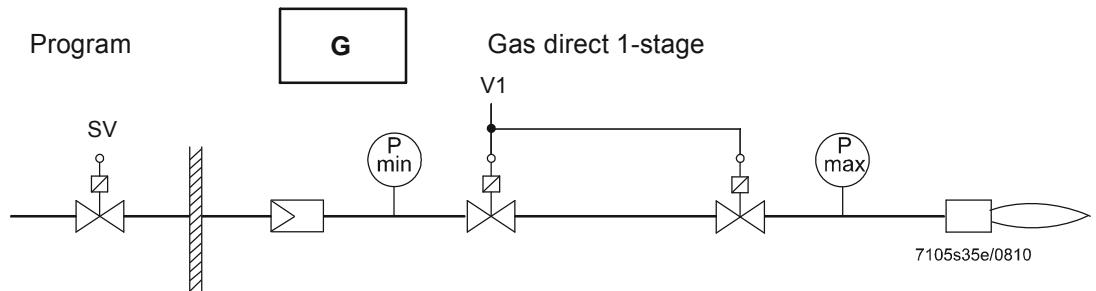
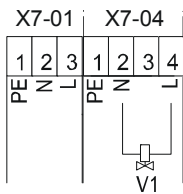

Figure 2: Fuel train gas direct ignition (G), 1-stage

6.2 Gas direct ignition (G), 1-stage, with valve proving

LME71.000...

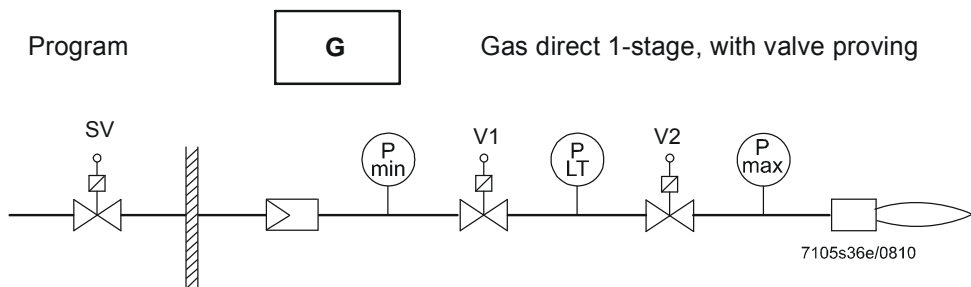
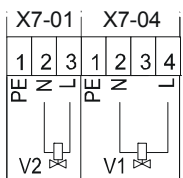

Figure 3: Fuel train gas direct ignition (G), 1-stage, with valve proving



Note:

When valve proving is activated (e.g. on shutdown), the load on the valve's terminals is restricted.

Fuel valve 1 terminal X7-04 pin 4/fuel valve 2 terminal X7-02 pin 3

- Rated voltage AC 120 V AC 230 V
 50/60 Hz 50/60 Hz
- Rated current 1 A 1 A
- Power factor $\cos\varphi > 0.4$ $\cos\varphi > 0.4$

If the terminal load is not reduced (max. rated current 2 A, $\cos\varphi > 0.4$), the design lifetime will be reached after about 100,000 burner startup cycles!

7 Gas valve proving

Valve proving is dependent on parameter 241. It is employed to detect leaking gas valves and, if necessary, to prevent the valves from opening or ignition from being switched on. Lockout is initiated.

Valve proving with separate pressure switch

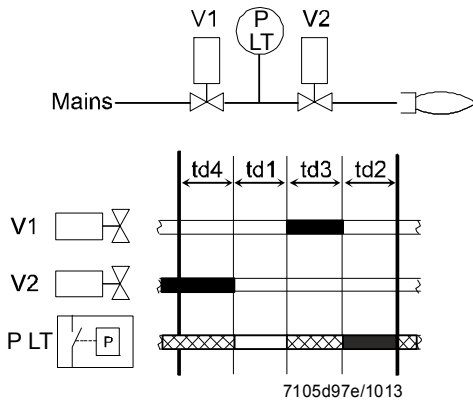

Fig. 4: Valve proving with separate pressure switch

Step 1: td4 – test space evacuating.

Gas valve on the burner side is opened to bring the test space to atmospheric pressure.

Step 2: td1 – test atmospheric pressure.

When the gas valve has closed, the gas pressure in the test space must not exceed a certain level.

Step 3: td3 – test space filling.

Gas valve on the mains side opens to fill the test space.

Step 4: td2 – test gas pressure.

When the gas valve has closed, the gas pressure in the test space must not drop below a certain level.

Legend

- td1 Test atmospheric pressure
- td2 Test gas pressure
- td3 Test space filling
- td4 Test space evacuating
- V... Fuel valve
- P LT Pressure switch valve proving
- Input/output signal 1 (ON)
- Input/output signal 0 (OFF)
- ▨ Permissible input signal 1 (ON) or 0 (OFF)

Query logic of gas pressure switch for valve proving:

- Gas pressure present → pressure switch closed
- Gas pressure not present → pressure switch open

Valve proving can be parameterized to take place on startup, shutdown, or both.

Recommendation:

Perform valve proving on shutdown.

No.	Parameter
241.00	Valve proving 0 = OFF 1 = ON ¹⁾
242	Valve proving test space evacuating
243	Valve proving time test atmospheric pressure
244	Valve proving test space filling
245	Valve proving time test gas pressure

¹⁾ Valve proving during postpurging, if parameter 234 >0 (postpurge time) and parameter 241.01 = 1

Program sequence with valve proving

During startup	<p>Valve proving during startup is performed only after a reset from the lockout position, after power ON, and when parameter 234 = 0 seconds.</p> <p>In that case, valve proving takes place at the same time as prepurging. This means that the prepurge time corresponds to at least the sum of all 4 valve proving parameters (242, 243, 244, 245).</p>
During shutdown	<p>Valve proving during shutdown is performed only if the postpurge time >0 (parameter 234 >0). If no postpurge time is parameterized, valve proving takes place during startup when prepurging.</p> <p>During shutdown (heat request OFF), it is checked if parameter 241 = 1 (valve proving ON) and parameter 234 ≠ 0 seconds before the valves close.</p> <p>This means that, first, fuel valve 1 is closed. Fuel valve 2 remains open, so that the remaining gas in the test space can be burned. The postpurge time runs at the same time as valve proving. This means that the postpurge time corresponds to at least the sum of all 4 valve proving parameters (242, 243, 244, 245).</p> <p>During valve proving, the prepurge speed / postpurge speed remains at the value set for parameter 503.01.</p>



Note!

If valve proving is parameterized to take place on startup and shutdown, the gas valves must run through additional switching cycles. As a result, strain (wear) on the gas valves and the relay increases.



Warning!

The OEM must set the evacuation, filling and test times for atmospheric or mains pressure on every plant in compliance with the requirements of EN 1643. If not observed, there is a risk of impairment of safety functions.

It must be ensured that the 2 test times are correctly set. It is to be checked whether the gas required for the test may be fed into the combustion chamber (on the relevant application). The test times are safety-related. After a reset and in the case of aborted or prevented valve proving, the unit will perform valve proving the next time it is started up (only when valve proving is activated). In the case of valve proving, prepurging is active during the startup phase, even if it has been deactivated.

Examples of aborted valve proving:

When the safety loop or the start release input for gas (containing pressure switch-min) opens during valve proving.

Valve proving – calculation of leakage rate

$$t_{\text{Test}} = \frac{(P_G - P_W) \cdot V \cdot 3600}{P_{\text{atm}} \cdot Q_{\text{Leak}}}$$

QLeak	in l/h	Leakage rate in liters per hour
PG	in mbar	Overpressure between the valves at the beginning of the test phase
PW	in mbar	Overpressure set on the pressure switch (normally 50% of the gas inlet pressure)
Patm	in mbar	Absolute air pressure (1013 mbar normal pressure)
V	in l	Volume between the valves (test volume) including valve volume and pilot pipe, if present
tTest	in s	Test time

8 Input gas pressure switch-min

Behavior in the event gas pressure switch-min fails (terminal X5-01 pin 2 and 3)

If gas pressure switch-min fails, safety shutdown is triggered and startup prevented until gas pressure switch-min closes again. During start prevention, the yellow LED is lit and the safety circuit is active. Burner control operates in phase 90.

9 Time table and settings

Type	Times in seconds														
	tw	TSA max.	t1 P225 4) min.	t3 P226 min.	t3n P257 approx.	t4 P230 min.	t8 P234 5) min.	t10 P224 approx.	t11 approx.	t12 approx.	1)	2)	3)	td1 P243 td2 P245 min.	td3 P244 td4 P242 max.
Requirements	2,5	3	20	3	2,5	15	4	15	60	60	---	---	---	10	3
Factory setting	---	t3n+0,45	19,404+2,1	3,087	2,205+0,3	15,582	4,851	13,818	58,212	58,212	---	---	---	10,29	2,646
Max.	2,5	14	1237+2,1	37,485	13,23+0,3	74,97	1237	13,818	---	---	1	0,45	0,45	37,485	2,646
Min.	---	---	0+2,1	1,029	0+0,3	3,234	0	0	---	---	0,3	0,3	---	1,029	0
Step size	---	---	4,851	0,147	0,147	0,294	4,851	0,294	---	---	---	---	---	0,147	0,147

Function parameter	Parameter number	Factory setting
Air pressure switch input 0 = inactive 1 = active	235	0
Repetition in the event of loss of flame during operation <2: None = 2: 1 x repetition	240.00	0
Repetition in the event of loss of flame on the end of safety time <2: None = 2: 1 x repetition = 3: 2 x repetition = 4: 3 x repetition	240.01	0
Valve proving 0: OFF 1: ON	241.00	0
Valve proving 0: During prepurge time 1: During postpurge time	241.01	1
Valve proving 0: According to parameter 241.01 1: During prepurge time and postpurge time	241.02	0

Legend

tw	Waiting time
TSA	Safety time
t1	Prepurge time
t3	Preignition time
t3n	Postignition time parameter 257 +0.3 seconds
t4	Interval: End of safety time - load controller release
t8	Postpurge time
t10	Specified time air pressure switch message (timeout)
t11	Opening time of actuator (timeout)
t12	Closing time of actuator (timeout)
td1	Test atmospheric pressure
td2	Test gas pressure
td3	Test space filling
td4	Test space evacuating
1)	Reaction time to a change of signal by the air pressure switch contact (opens) and flame-out response time in the event of loss of flame
2)	Reaction time to a change of signal by the inputs (e.g. pressure switch-min)
3)	Flame detection time
4)	Minimum time $td1 + td2 + td3 + td4$ if: Parameter 241.00 = 1 (ON, after mains ON, with lockout, parameter 234 (postpurge time) = 0 (postpurging) or parameter 241.01 = 0
5)	Minimum time $td1 + td2 + td3 + td4$ if: Parameter 241.00 = 1 (ON) and parameter 234 (postpurge time) >0 (postpurging) and parameter 241.01 = 1

10 Inputs and outputs / internal connection diagram

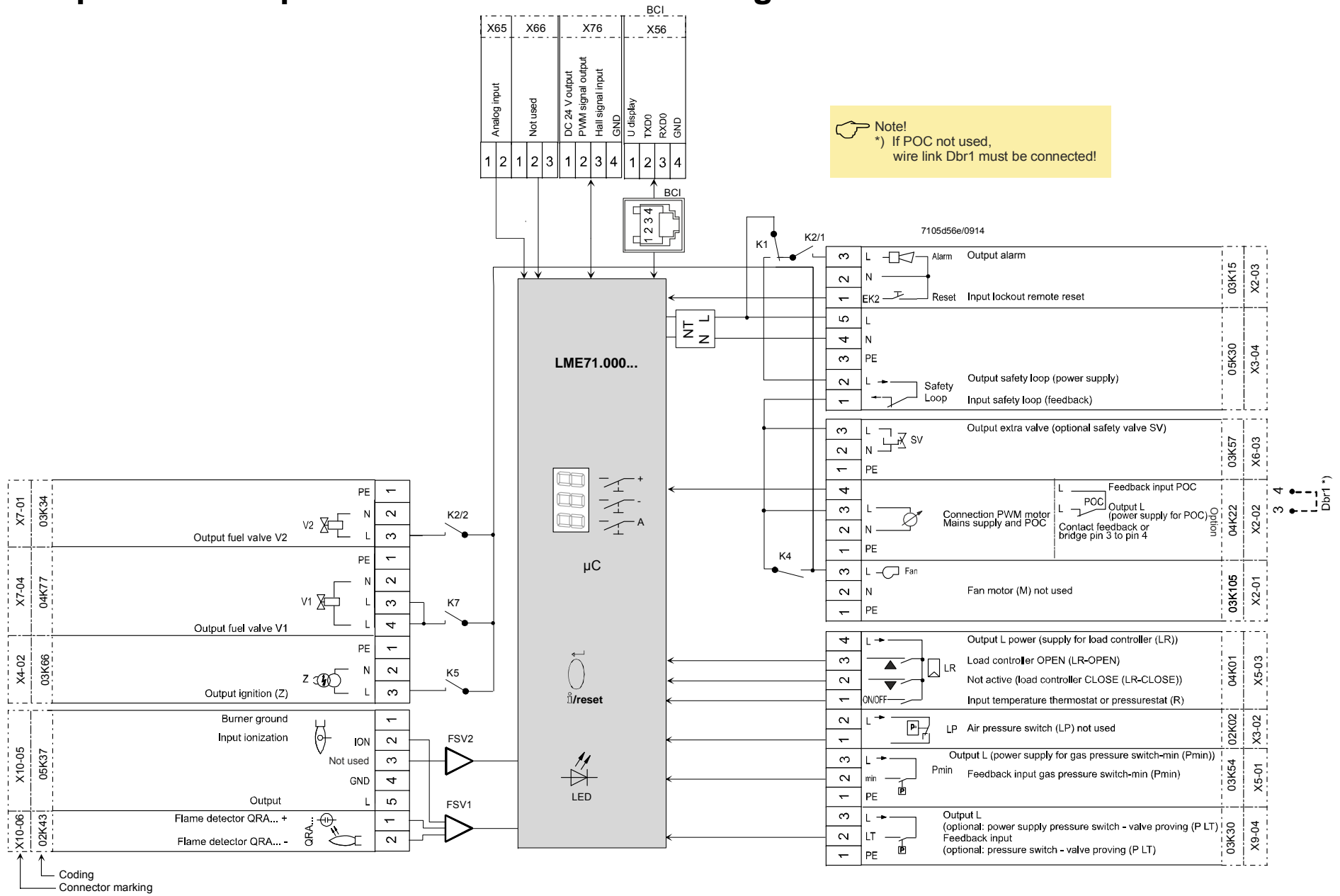

Figure 5: Inputs and outputs / internal connection diagram

11 Parameter list (AZL2...)

Parameter number	Parameter	Edit	Value range		Resolution	Factory setting	Password level reading from level	Password level writing from level
			Min.	Max.				
000	Internal parameter							
41	Heating engineer's password (4 characters)	Edit	xxxx	xxxx	---	---	---	OEM
42	OEM's password (5 characters)	Edit	xxxxx	xxxxx	---	---	---	OEM
60	Backup/restore	Edit	Restore	Backup	---	---	---	SO
100	General							
102	Identification date	Read only	---	---	---	---	Info	---
103	Identification number	Read only	0	9999	1	0	Info	---
113	Burner identification	Edit	x	xxxxxxxx	1	burnErlD	Info	SO
120	Type of PME program modules	Read only	xxxxx.xxxxx	xxxxx.xxxxx	---	PME7x.xxxxx	Only via ACS410	---
123	Minimum load positioning step	Edit	1%	10%	0.1	2	SO	SO
140	Mode display of display and operating unit AZL2... 1 = standard (program phase) 2 = flame 1 (QRA.../ION) 3 = flame 2 (QRB.../QRC...) ⇒ not used 4 = active power (power value)	Edit	1	4	1	4	SO	SO
164	Number of startups resettable	Resettable	0	999999	1	0	Info	Info
166	Total number of startups	Read only	0	999999	1	0	Info	---
170.00	Switching cycles relay contact K12 ⇒ not active	Read only	0	999999	1	0	Info	---
170.01	Switching cycles relay contact K11 ⇒ not active	Read only	0	999999	1	0	Info	---
170.02	Switching cycles relay contact K2	Read only	0	999999	1	0	Info	---
170.03	Switching cycles relay contact K1	Read only	0	999999	1	0	Info	---
171	Max. switching cycles relay	Read only	0	999999	1	0	Info	---

Parameter number	Parameter	Edit	Value range		Resolution	Factory setting	Password level reading from level	Password level writing from level
			Min.	Max.				
200	Burner control							
224	Special time air pressure switch	Edit	0 s	13.818 s	0.294 s	13.818 s	SO	OEM
225	Prepurge time +2.1 seconds	Edit	0 s	1237 s	4.851 s	29.106 s	SO	OEM
226	Preignition time	Edit	1.029 s	37.485 s	0.147 s	3.087 s	SO	OEM
230	Interval: End of safety time - load controller release	Edit	3.234 s	74.97 s	0.294 s	15.582 s	SO	OEM
234	Postpurge time	Edit	0 s	1237 s	4.851 s	4.851 s	SO	OEM
235	Air pressure switch input 0 = inactive 1 = active	Edit	0	1	1	0	SO	OEM
240.00	Repetition in the event of loss of flame during operation <2: None = 2: 1 x repetition	Edit	0	2	1	0	SO	OEM
240.01	Repetition in the event of loss of flame on the end of safety time <2: None = 2: 1 x repetition = 3: 2 x repetition = 4: 3 x repetition	Edit	0	4	1	0	SO	OEM
241.00	Valve proving 0: OFF 1: ON	Edit	0	1	1	0	SO	OEM
241.01	Valve proving 0: During prepurge time 1: During postpurge time	Edit	0	1	1	1	SO	OEM
241.02	Valve proving 0: According to parameter 241.01 1: During prepurge time and postpurge time	Edit	0	1	1	0	SO	OEM
242	Valve proving test space evacuating	Edit	0 s	2.648 s	0.147 s	2.648 s	SO	OEM
243	Valve proving time test atmospheric pressure	Edit	1.029 s	37.485 s	0.147 s	10.290 s	SO	OEM
244	Valve proving test space filling	Edit	0 s	2.648 s	0.147 s	2.648 s	SO	OEM
245	Valve proving time test gas pressure	Edit	1.029 s	37.485 s	0.147 s	10.290 s	SO	OEM
257	Postignition time +0.3 seconds	Edit	0 s	13.23 s	0.147 s	2.205 s	SO	OEM

Parameter number	Parameter	Edit	Value range		Resolution	Factory setting	Password level reading from level	Password level writing from level
			Min.	Max.				
400	Ratio control (operation)							
403.00	Fan speed: Ignition load speed (P0)	Edit	800 U/min	9000 U/min	10 U/min	3000 U/min	SO	SO
403.01	Fan speed: Low-fire speed (P1)	Edit	400 U/min	9000 U/min	10 U/min	1200 U/min	SO	SO
403.02	Fan speed high-fire speed (P2)	Edit	800 U/min	9000 U/min	10 U/min	5700 U/min	SO	SO
500	Ratio control							
503.00	No-flame speeds PWM fan: Standby speed	Edit	0 U/min	9000 U/min	10 U/min	0 U/min	SO	SO
503.01	No-flame speeds PWM fan: Prepurge speed / postpurge speed	Edit	800 U/min	9000 U/min	10 U/min	5700 U/min	SO	SO
516.00	Speed limit ignition load P0: Minimum limit	Edit	800 U/min	9000 U/min	10 U/min	800 U/min	SO	OEM
516.01	Speed limit ignition load P0: Maximum limit	Edit	800 U/min	9000 U/min	10 U/min	9000 U/min	SO	OEM
517.00	Speed limit low-fire P1: Minimum limit	Edit	400 U/min	9000 U/min	10 U/min	400 U/min	SO	OEM
517.01	Speed limit low-fire P1: Maximum limit	Edit	800 U/min	9000 U/min	10 U/min	9000 U/min	SO	OEM
518.00	Speed limit high-fire P2: Minimum limit	Edit	800 U/min	9000 U/min	10 U/min	800 U/min	SO	OEM
518.01	Speed limit high-fire P2: Maximum limit	Edit	800 U/min	9000 U/min	10 U/min	9000 U/min	SO	OEM
519	Maximum fan speed	Edit	3000 U/min	9000 U/min	10 U/min	5830 U/min	SO	OEM
522	Ramp-up low-fire → high-fire	Edit	2.058 s	74.970 s	0.294 s	14.994 s	SO	OEM
523	Ramp-down high-fire → low-fire	Edit	2.058 s	74.970 s	0.294 s	14.994 s	SO	OEM
558	Mode: UDS status information 0 = PC tool mode 1 = PWM mode 2 = actuator mode 3 = internally 4 = internally 5 = internally	Read only	0	5	1	0	SO	---
559	PWM mode 0 = Control 1 = PID control 2 = safety mode (PWM limits)	Edit	0	2	1	1	SO	OEM
560	Pneumatic ratio control 0 = OFF / 3-position modulation 1 = PWM fan / analog modulation 2 = air damper / analog modulation (feedback potentiometer ASZxx.3x required)	Read only	0	2	1	1	SO	---

Parameter number	Parameter	Edit	Value range		Resolution	Factory setting	Password level reading from level	Password level writing from level
			Min.	Max.				
600	Power setting							
644	Number of pulses per revolution	Edit	2	5	1	3	SO	OEM
646	Settling time for assessment of speed	Edit	1.029 s	2.058 s	0.147 s	2.058 s	SO	OEM
650.00	Speed tolerance band: Speed shutdown	Edit	1%	5%	1%	1%	SO	OEM
650.01	Speed tolerance band: Quick speed shutdown	Edit	1%	10%	1%	3%	SO	OEM
654	Analog input (feedback potentiometer ASZxx.3x required) 0 = 3-position step input 1 = 0...10 V 2 = 0...135 Ω 3 = 0...20 mA 4 = 4...20 mA with lockout at I <4 mA 5 = 4...20 mA	Edit	0	5	1	1	SO	SO
658.00	PWM values fan: Start PWM	Edit	1%	100%	1%	25%	SO	OEM
658.01	PWM values fan: Min. PWM operating range	Edit	0%	20%	1%	0%	SO	OEM
658.02	PWM values fan: Max. PWM operating range	Edit	80%	100%	1%	100%	SO	OEM
659.00	Ramp time of fan: Min. low-fire to high-fire	Read only	0 s	74.970 s	0.294 s	2.058 s	SO	---
659.01	Ramp time of fan: Max. low-fire to high-fire	Read only	0 s	74.970 s	0.294 s	74.970 s	SO	---
659.02	Ramp time of fan: Min. high-fire to low-fire	Read only	0 s	74.970 s	0.294 s	2.058 s	SO	---
659.03	Ramp time of fan: Max. high-fire to low-fire	Read only	0 s	74.970 s	0.294 s	74.970 s	SO	---
660	Tolerance time speed deviation	Read only	0 s	37.485 s	0.147 s	4.998 s	SO	---
674	Neutral band (permitted control offset)	Edit	0 U/min	255 U/min	1 U/min	40 U/min	SO	OEM
675.00	PWM: Min. PWM with prepurging, SEC	Edit	0%	100%	1%	86%	SO	OEM
675.01	PWM: Max. PWM with ignition load, SEC	Edit	0%	100%	1%	34%	SO	OEM
676	Gain factor speed control	Read only	0	255	1	112	SO	---
677	Integral action time speed control	Read only	0 s	37.485 s	0.147 s	0.441 s	SO	---
678	Derivative action time speed control	Read only	0 s	37.485 s	0.147 s	0 s	SO	---
679.00	Time constant Pt1 speed control: Lower speed range high-fire to low-fire	Edit	0 s	37.485 s	0.147 s	6.027 s	SO	OEM
679.01	Time constant Pt1 speed control: Medium speed range high-fire to low-fire	Edit	0 s	37.485 s	0.147 s	6.027 s	SO	OEM
679.02	Time constant Pt1 speed control: Upper speed range high-fire to low-fire	Edit	0 s	37.485 s	0.147 s	6.027 s	SO	OEM
679.03	Time constant Pt1 speed control: Total speed range low-fire to high-fire	Edit	0 s	37.485 s	0.147 s	6.027 s	SO	OEM
680.00	Speed range for Pt1 time constant: Threshold upper speed range	Edit	800 U/min	9000 U/min	10 U/min	4000 U/min	SO	OEM
680.01	Speed range for Pt1 time constant: Threshold lower speed range	Edit	800 U/min	9000 U/min	10 U/min	2000 U/min	SO	OEM

Parameter-number	Parameter	Edit	Value range		Resolution	Factory setting	Password level reading from level	Password level writing from level
			Min.	Max.				
700	Error history							
701	Current error: 00: Error code 01: Startup meter reading 02: HMI phase 03: Power value	Read only	2 0 --- 0%	255 999999 --- 100%	1 1 --- 1	---	Service	---
702	Error history former 1: 00: Error code 01: Startup meter reading 02: HMI phase 03: Power value	Read only	2 0 --- 0%	255 999999 --- 100%	1 1 --- 1	---	Service	---
•								
•								
•								
711	Error history former 10: 00: Error code 01: Startup meter reading 02: HMI phase 03: Power value	Read only	2 0 --- 0%	255 999999 --- 100%	1 1 --- 1	---	Service	---
900	Process data							
920	Current PWM signal fan	Read only	0%	100%	1%	---	Service	---
936	Normalized speed	Read only	0%	100%	1%	---	Service	---
951	Mains voltage	Read only	0 V	LME71.000A1: 175 V LME71.000A2: 350 V	1 V	---	Service	---
954	Flame intensity	Read only	0%	100%	1%	---	Service	---

12 PWM settings

12.1 Relevant parameters



Note:
Initial parameter settings (also see chapter *Initial PWM parameter settings*)!
Display depends on program.

Parameter	Meaning
P0	<p>Ignition load speed (parameter 403:[0] in ACS410 software): Corresponds to the ignition load speed in revolutions per minute (rpm). Prerequisite: $P0 \geq P0_{min}$ (parameter 516.00), $P0 \leq P0_{max}$ (parameter 516.01)</p> <p>Note: Step size of speed when making the setting with AZL2... operating unit: 10 rpm Step size of speed when making the setting with PC software ACS410: 1 rpm</p>
P1	<p>Low-fire speed (parameter 403:[1] in ACS410 software): Corresponds to the low-fire speed in revolutions per minute (rpm). Prerequisite: $P1 \geq P1_{min}$ (parameter 517.00), $P1 \leq P1_{max}$ (parameter 517.01)</p> <p>Note: Step size of speed when making the setting with operating unit AZL2...: 10 rpm Step size of speed when making the setting with PC software ACS410: 1 rpm</p>
P2	<p>High-fire speed (parameter 403:[3] in ACS410 software): Corresponds to the high-fire speed in revolutions per minute (rpm). Prerequisite: $P2 \geq P2_{min}$ (parameter 518.00), $P2 \leq P2_{max}$ (parameter 518.01)</p> <p>Note: Step size of speed when making the setting with operating unit AZL2...: 10 rpm Step size of speed when making the setting with PC software ACS410: 1 rpm</p>
503.00	<p>Standby speed: Corresponds to the standby speed in revolutions per minute (rpm), delivered as a PWM value in standby (OFF) or lockout position 1! This means that a connected PWM fan ensures purging at this speed in standby (OFF) or, when using a mains-powered fan, in lockout position 1 as well. In that case, compliance with the connection diagram of the PWM fan must be ensured!</p> <p>When using mains-powered fans, following must be observed:</p> <ul style="list-style-type: none"> In terms of mains supply, the fan is no longer connected to the LME7... and, in the event of fault/lockout, will not be disconnected from mains supply The PWM interface integrated in the fan must ensure safe electrical separation from mains (e.g. via optocoupler) No PWM signal is delivered in lockout position 0 (LOC10). The PWM fan does not provide purging in this lockout position <p>Note: Step size of speed when making the setting with operating unit AZL2...: 10 rpm Step size of speed when making the setting with PC software ACS410: 1 rpm</p>
503.01	<p>Prepurge speed / postpurge speed: Corresponds to the speed in revolutions per minute (rpm) used by the fan for pre- and/or postpurging and/or valve proving.</p> <p>Note: Step size of speed when making the setting with operating unit AZL2...: 10 rpm Step size of speed when making the setting with PC software ACS410: 1 rpm</p>
516.00	<p>Minimum limit speed ignition load P0: Corresponds to the minimum speed for ignition load P0 in revolutions per minute (rpm) at which the burner can still be securely ignited. Prerequisite: Parameter $516.00 \leq P0$</p> <p>Note: Step size of speed when making the setting with operating unit AZL2...: 10 rpm Step size of speed when making the setting with PC software ACS410: 1 rpm</p>

Parameter	Meaning
516.01	<p>Maximum limit speed ignition load P0: Corresponds to the maximum speed for ignition load P0 in revolutions per minute (rpm) at which the burner may still be securely ignited. Prerequisite: Parameter 516.01 \geq P0</p> <p>Note: Step size of speed when making the setting with operating unit AZL2...: 10 rpm Step size of speed when making the setting with PC software ACS410: 1 rpm</p>
517.00	<p>Minimum limit speed low-fire P1: Corresponds to the minimum speed for low-fire P1 in revolutions per minute (rpm) at which the burner still operates safely in the low-fire range. Prerequisite: Parameter 517.00 \leq P1 fan speed</p> <p>Note: Step size of speed when making the setting with operating unit AZL2...: 10 rpm Step size of speed when making the setting with PC software ACS410: 1 rpm</p>
517.01	<p>Maximum limit speed low-fire P1: Corresponds to the maximum speed for low-fire P1 in revolutions per minute (rpm) at which the burner still operates safely in the low-fire range. Prerequisite: Parameter 517.01 \geq P1</p> <p>Note: Step size of speed when making the setting with operating unit AZL2...: 10 rpm Step size of speed when making the setting with PC software ACS410: 1 rpm</p>
518.00	<p>Minimum limit speed high-fire P2: Corresponds to the minimum speed for high-fire P2 in revolutions per minute (rpm) for the burner operating in the high-fire range. Prerequisite: Parameter 518.00 \leq P2</p> <p>Note: Step size of speed when making the setting with operating unit AZL2...: 10 rpm Step size of speed when making the setting with PC software ACS410: 1 rpm</p>
518.01	<p>Maximum limit speed high-fire P2: Corresponds to the maximum speed for high-fire P2 in revolutions per minute (rpm) at which the burner may operate. Prerequisite: Parameter 518.01 \geq P2</p> <p>Note: Step size of speed when making the setting with operating unit AZL2...: 10 rpm Step size of speed when making the setting with PC software ACS410: 1 rpm</p>
519	<p>Maximum fan speed Corresponds to the maximum fan speed (see supplier's Data Sheet).</p>
644	<p>Number of pulses per revolution Corresponds to the number of (Hall signal) pulses per revolution the fan feeds back to the control (see supplier's Data Sheet).</p>
658.00	<p>Startup PWM PWM value the PWM fan needs as a minimum to start from standstill (see supplier's Data Sheet).</p>
658.01	<p>Minimum operating limit of PWM Represents the minimum limit value of PWM, which fan speed control does not cross.</p>
658.02	<p>Maximum operating limit of PWM Represents the maximum limit value of PWM, which fan speed control does not cross.</p>

12.2 PWM control parameters

Parameter	Meaning
522	Ramp-up Control parameter "Ramp time" is the preset time in seconds (s) within which the PWM signal reaches the setpoint with a positive setpoint step (0 rpm to high-fire rpm). Factory setting: Approx. 15 seconds
523	Ramp-down Control parameter "Ramp time" is the preset time in seconds (s) within which the PWM signal reaches the setpoint with a negative setpoint step (high-fire rpm to 0 rpm). Factory setting: Approx. 15 seconds
646	Settling time for assessment of speed The current speed must lie within tolerance band 1 (parameter 650.00) of the required speed for this period of time before the target speed is considered reached (speed release).
650.00	Tolerance band 1 (speed shutdown) Factory setting: 1% If the current speed leaves value range <i>Required speed ± set tolerance band 1</i> for a period of time exceeding the time set with parameter 646, lockout Loc 83 will be initiated.
650.01	Tolerance band 2 (quick speed shutdown) Factory setting: 3% If the current speed leaves value range <i>Required speed ± set tolerance band 2</i> , lockout Loc 83 will immediately be initiated.
660	Tolerance time speed deviation A speed deviation outside tolerance band 1 (parameter 650.00) will be tolerated for the period of time set. If it lasts longer, lockout Loc 83 will be initiated.
674	Neutral band Minimum speed change in revolutions per minute. Factory setting: 40 rpm Protection from speed oscillations. Only control offsets with speed changes above the setting value will be corrected (dead band).
679.00	Time constant Pt1 controller for speed control in the upper speed range high-fire to low-fire.
679.01	Time constant Pt1 controller for speed control in the medium speed range high-fire to low-fire.
679.02	Time constant Pt1 controller for speed control in the lower speed range high-fire to low-fire.
679.03	Time constant Pt1 controller for speed control in the entire speed range low-fire to high-fire.
680.00	Threshold between upper and medium speed range for control parameters 679.02 and 679.01.
680.01	Threshold between medium and lower speed range for control parameters 679.01 and 679.00.

12.3 PWM safety parameters



Note:
Also see chapter *Initial PWM parameter settings*.

Parameter	Meaning
559	PWM mode control Determines the behavior of PWM control, delivering a PWM signal proportional to the preset output (analog/3-position step input). Control: Controls the PWM speed proportional to the output preset via the analog or 3-position step input. Safety mode: Control for defining the PWM safety parameters.
675.00	Minimum PWM with prepurging, SEC Minimum PWM signal in percent for prepurging
675.01	Maximum PWM with ignition load, SEC Maximum PWM signal in percent for ignition load
920	(Current) PWM signal fan PWM signal in percent. Readable on the service level with AZL2... (press Info button for >3 seconds).

12.4 Initial PWM parameter settings

12.4.1 Initial settings of PWM basic parameters



Note:





The initial settings of the PWM basic parameter are made exclusively on the OEM level.

Prerequisites

- Operating unit AZL2... for setting the parameters is connected
- Unit is wired up in accordance with the proposed application
- Mains voltage is available
- Safety loop is closed
- There is no heat request, unit is in standby (OFF)
- Fan parameters, such as maximum speed and Hall signal (number of pulses per revolution) are known
- With unprogrammed program module (initial settings), AZL2... displays **OFF UPr**
- With unprogrammed program module (initial settings), the onboard operating panel of the LME7... displays **UPr**

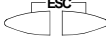
Operating steps























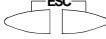



- Select programming mode for OEM
- Press **A** and **F** simultaneously for <5 seconds. Display shows **CodeE**
- Enter the OEM's password via **+**, **-** and **↻/reset**. Also see chapter *Entering the password* in LME7 Basic Documentation (P7105).
- Display shows **PArA** and then **400: SEt**. Confirm by pressing **↻/reset**
- Unit jumps to setting parameter **P0** (ignition load position) **516.00** (**516** blinking).
Keep **↻/reset** depressed for >1 second. Subindex **00** is blinking
- Keep **↻/reset** depressed for >1 second. Display changes to **-**. Also see chapter *Setting parameters with index, with or without direct display* in LME7 Basic Documentation (P7105).
- By pressing **+** or **-** the speed can be changed in step sizes of 10 rpm. Set the required minimum limit speed for the ignition load position at which the burner can still be safely ignited
- Press **↻/reset** to transfer the setting value to the onboard memory
- By pressing **-** **+** (press **+** and **-** simultaneously) you leave the entry level and return to the selection level for the subindex
- Subindex **00** blinks. Press **+** to select the next subindex. Subindex **01** blinks
- Press **↻/reset** for >1 second. Display changes to **-**
- By pressing **+** or **-** the speed can be changed in step sizes of 10 rpm. Set the required maximum limit speed for the ignition load position at which the burner may still be safely ignited





































- Press  to transfer the setting value to the onboard memory
- By pressing  twice (press  and  simultaneously) you leave the entry level and return to the selection level for the parameter number
- Parameter number **516** blinks. Press  to select the next parameter. Parameter **517** blinks



Now, for the following parameters, proceed as described above:

- **P1** low-fire position **517**

- **P2** high-fire position **518**

- For parameter number **519**, press  for >1 second
- By pressing  or  the speed can be changed in step sizes of 10 rpm. Also see chapter *Setting parameters without index, without direct display*. Set the required maximum speed for the connected fan (also see the supplier's Data Sheet)
- Press  to transfer the setting value to onboard memory
- By pressing  (press  and  simultaneously) you leave the entry level and return to the selection level for the parameters
- Parameter number **519** blinks. Press  to select the next parameter. Parameter **644** blinks
- Press  for >1 second
- By pressing  or  the number of pulses per revolution (Hall signals) the unit feeds back to the control can be set (see supplier's Data Sheet)
- Press  to transfer the setting value to the onboard memory
- By pressing  (press  and  simultaneously) you leave the entry level and return to the selection level for the parameters
- Parameter number **644** blinks. Press  to select the next parameter. Parameter **P0** blinks
- By pressing  (display changes to **0A** and speed appears blinking) and pressing  or  the speed can be changed within the predefined limits (**P0max**, **P0min**) in step sizes of 10 rpm
- Press  to transfer the setting value to the onboard memory and the next parameter **P1**
- By pressing  (display changes to **1A** and speed appears blinking) and pressing  or  the speed can be changed within the predefined limits (**P1max**, **P1min**) in step sizes of 10 rpm
- Press  to transfer the setting value to the onboard memory and the next parameter **P2**
- By pressing  (display changes to **2A** and speed appears blinking) and pressing  or  the speed can be changed within the predefined limits (**P2max**, **P2min**) in step sizes of 10 rpm

- Press  to transfer the setting value to the onboard memory and to complete the initial settings
- Display shows **-END-**
- By pressing  (press  and  simultaneously) you leave the entry level and return to the selection level for the parameters
- Display changes from **PArA** to **400: SEt**
- Press  to select the next parameter group (500...600). Display: **500: PArA**
- Press  to go to the respective group
- Press  or  to select parameter **503.00** (**503** blinking)
- Press  for >1 second. Subindex **00** blinks
- Press  or  to select subindex **01**
- Press  for >1 second. Display shows the prepurge speed. Also see chapter *Setting parameters with index, with or without direct display* in LME7 Basic Documentation (P7105).
- By pressing  or  the speed can be changed in step sizes of 10 rpm. Set the required minimum prepurge speed
- Press  to transfer the setting value to the onboard memory
- By pressing  3 times (press  and  simultaneously) you leave the entry level and return to the selection levels for the subindex. Parameter for returning to the parameter group (display shows **500: PArA**)
- Press  to select the next parameter group (600...700). Display shows **600: PArA**
- Press  to go to the respective group
- Press  or  to select parameter **675.00** (**675** blinking)
- Press  for >1 second. Subindex **00** blinks
- Press  to go to the respective group
- Press  or  to set the value to 40%
- Press  to transfer the setting value to the onboard memory
- By pressing  3 times (press  and  simultaneously) you leave the parameter level and return to the subindex
- Press  or  to select subindex **01**
- Press  to go to the respective group
- Press  or  to set the value to 55%
- Press  to transfer the setting value to the onboard memory

- By pressing  twice (press  and  simultaneously) you leave the parameter setting level and return to the initial mode











Warning!

In the case of burner components (PWM fan) with voltage-related behavior, it is recommended to read out the value (current PWM signal, parameter 920) for the prepurge phase (phase 30) with the minimum permissible prepurge speed close to the **undervoltage limit**, and for the ignition phases (phase 38, 40 and 44) with the maximum permissible ignition speed close to the **overvoltage limit**. If this is not observed, there is a risk of loss of safety functions.

12.4.2 Reading the value of parameter 920 in the prepurge phase (Ph30) and ignition load phase (Ph38, Ph40 and Ph44)

Procedure

- Set the ignition load speed (**P0**) for the burner to the maximum permissible value, and the prepurge speed (**503.01**) to the minimum value
- Let the AZL2... display service mode. Press  for >3 seconds. The display first shows **InFo**, then **SEr**
- Release  so that parameter number **701.00** starts blinking
- Press  or  to select parameter **920** (blinking)
- Start the burner
- Read the value of parameter **920** in the prepurge phase (P30) and ignition phase (P38, 40 and 44). Write down the values. They will be required as a basis for setting safety parameter **675.00**
- By pressing   (press  and  simultaneously) you leave the parameter setting level and return to the initial mode

Note:

If the onboard operating panel of the LME7... basic unit changes from phase display (e.g. P30) to **SEC** at 1-second intervals, or if the LME7... goes to lockout (**Loc: 225**), the difference between the actually required PWM value (parameter **936**) and safety parameter **675.00** or **675.01** is too small. Decrease value **675.00** (parameter **920 - 1%**) or increase value **675.01** (parameter **920 +1%**). Reduce the value until **SEC** disappears from the display.



12.4.3 Final settings of PWM safety parameters



Note:

PWM control by the LME7... makes use of the Hall signal for feedback. This Hall signal is used to calculate the manipulated variable of the PWM control process. To prevent the calculation of wrong manipulated variables in the event of incorrect Hall signals, the working range of PWM control must be restricted via parameter **675.00/675.01**. For that purpose, the burner is operated in special test mode (parameter **559**).



Warning!

In the case of burner components (PWM fan) with voltage-related behavior, it is recommended to read out the value (current PWM signal, parameter 920) for the prepurge phase (Ph30) with the minimum permissible prepurge speed close to the **undervoltage limit**, and for the ignition phases (Ph38, 40 and 44) with the maximum permissible ignition speed close to the **overvoltage limit**. If this is not observed, there is a risk of loss of safety functions.

Procedure

Select test mode (parameter **559**) and check the prepurge speed under worst-case conditions close to the undervoltage limit, or check the ignition load speeds under worst-case conditions close to the overvoltage limit:











































Reference:

In test mode (parameter **559**, setting value = 2), the normalized PWM signal (parameter **675.00**) for the prepurge phase or the PWM signal (parameter **675.01**) for the ignition phase is output as a fixed value. Start the burner and check the speed, the volumetric air flow or air pressures under these worst-case conditions by taking appropriate measures while ensuring compliance with the relevant standards (e.g. EN 676).

- Set safety parameter **675.00** to the value previously determined by parameter **920** in the prepurge phase (Ph30) **-1%** and safety parameter **675.01** to the value of parameter **920** in the ignition phase (Ph38, 40 and 48) **+1%**

Follow these steps

- Select programming mode for the OEM
- Press  and  simultaneously for <5 seconds. Display shows **Code**
- Enter the OEM's password via ,  and . Also see chapter *Entering the password* in LME7 Basic Documentation (P7105).
- Display changes from **PArA** to **400: SEt**
- Press  to select the next parameter group (500...600). Display shows **500: PArA**
- Press  to go to the respective group
- Press  or  to select parameter **559**
- Press 
- Press  or  to set the value (2 test modes)
- Press  to transfer the setting value to the onboard memory
- By pressing   twice (press  and  simultaneously) you leave the parameter setting level and return to the parameter group
- Press  to select the parameter group (600...700). Display shows **600: PArA**
- Press  to go to the respective group
- Press  or  to select parameter **675.00** (**675** blinking)
- Press  for >1 second. Subindex **00** blinks
- Press 
- Press  or  to set the previously determined value **-1%** of parameter **920** (prepurge phase (Ph30))
- Press  to transfer the setting value to the onboard memory
- By pressing   (press  and  simultaneously) you return to the subindex. Display shows **00** blinking
- Press  or  to select subindex **01**
- Press 
- Press  or  to set the previously determined value **-1%** of parameter **920** (ignition phase (Ph38, 40 and 44))
- Press  to transfer the setting value to the onboard memory
- By pressing   4 times (press  and  simultaneously) you leave the parameter setting level and return to the initial mode



Note:

Test mode is indicated by the unit's 7-segment display changing from **SEC** to the relevant program phase at 1-second intervals.

Checking prepurging

- To check the prepurge speed, set the required worst-case conditions close to the **undervoltage limit**
- Start the burner and check the speed, the volumetric air flow or air pressure by taking appropriate measures while ensuring compliance with the relevant standards (e.g. EN 676) in the prepurge phase (P30)
- If the worst-case requirements are not satisfied, change safety parameter **675.00** accordingly

Checking the ignition load

- To check the ignition load speed, set the required worst-case conditions close to the **overvoltage limit**
- Start the burner and check the speed, the volumetric air flow or air pressure by taking appropriate measures while ensuring compliance with the relevant standards (e.g. EN 676) in the ignition phase (P38, P40 or P44)
- If the worst-case requirements are not satisfied, change safety parameter **675.01** accordingly

On successful completion of the test, reset parameter **559** to control as described above (setting value = 1).



Note:

To store the settings in the PME... program module, a manual backup is required. Also see chapter *Manual backup* in LME7 Basic Documentation (P7105).

12.4.4 Setting safety parameters 675.00/675.01 and checking the safety settings under worst-case conditions

Procedure

Select test mode (parameter **559**) and check the prepurge speed under worst-case conditions close to the undervoltage limit, or check the ignition load speeds under worst-case conditions close to the overvoltage limit:

Note:



In test mode (parameter **559**, setting value = 2), the normalized PWM signal (parameter **675.00**) for the prepurge phase or the PWM signal (parameter **675.01**) for the ignition phase is output as a fixed value. Start the burner and check the speed, the volumetric air flow or air pressure under these worst-case conditions by taking appropriate measures while ensuring compliance with the relevant standards (e.g. EN 676).

Follow these steps

- Select programming mode for the OEM
- Press and simultaneously for <5 seconds. Display shows **CodeE**
- Enter the OEM's password via , and . Also see chapter *Entering the password* in LME7 Basic Documentation (P7105).
- Display changes from **PArA** to **400: SEt**
- Press to select the next parameter group (500...600). Display shows **500: PArA**
- Press to go to the respective group
- Press or to select parameter **559**
- Press
- Press or to set the value (2 test modes)
- Press to transfer the setting value to the onboard memory
- By pressing twice (press and simultaneously) you leave the parameter setting level and return to the parameter group

Checking prepurging

- To check the prepurge speed, set the required worst-case conditions close to the **undervoltage limit**
- Start the burner and check the speed, the volumetric air flow or air pressure by taking appropriate measures while ensuring compliance with the relevant standards (e.g. EN 676) in the prepurge phase (P30)
- If the worst-case requirements are not satisfied, change safety parameter **675.00** accordingly

Checking the ignition load

- To check the ignition load speed, set the required worst-case conditions close to the **overvoltage limit**
- Start the burner and check the speed, the volumetric air flow or air pressure by taking appropriate measures while ensuring compliance with the relevant standards (e.g. EN 676) in the ignition phase (P38, P40 or P44)
- If the worst-case requirements are not satisfied, change safety parameter **675.01** accordingly

On successful completion of the test, reset parameter **559** to control as described above (setting value = 1).



Note:



To store the settings in the PME... program module, a manual backup is required. Also see chapter *Manual backup* in LME7 Basic Documentation (P7105).

12.4.5 Matching the working points “Speeds for low-fire (P1), ignition load (P0) and high-fire (P2) for the heating engineer to the application

Prerequisites

- Initial settings of the basic PWM parameters on the OEM level are made
- Unit is wired up in accordance with the proposed application
- Mains voltage is available
- Safety loop is closed
- There is no heat request, unit is in standby (OFF)

12.4.6 ... via the onboard operating panel of the LME7... basic unit

- Keep  and  or  simultaneously depressed for >5 seconds.
- Display shows **OFF** blinking

Note:

If there is no operating action for >30 seconds, the LME7... changes automatically to standard mode. This means that adaptation of the working points must be started again.





- Heat request (temperature controller) ON
- Basic unit is started and runs through the startup phase. Then, the unit runs through the respective program phases in accordance with the program sequence; the numbers appear blinking
- The unit proceeds to the end of the prepurge phase (P30), goes to the start load position and then displays **P0** (ignition load speed). In the process, the display shows alternately **P0** and a 3-digit number

Note:

The 3-digit number shows the setting value for parameter **P0/P1** or **P2** as the speed and must be multiplied by 10.













- By pressing  and  or  the speed can be changed in step sizes of 10 rpm within the limits predefined by the OEM (**P0max**, **P0min**)

Note!

The setting value of P0 must be greater than the setting value of P1. The basic unit checks the setting values. If setting rules are violated, the unit goes to lockout and displays error message Loc: 225.



- Press  to transfer the setting value to the onboard memory
- The startup phase proceeds. The burner is ignited. The program proceeds to low-fire position **P1**. In the process, the display shows alternately **P1** and the speed
- By pressing  and  or  the speed can be changed in step sizes of 10 rpm within the limits predefined by the OEM (P1max, P1min)
- Press  to transfer the setting value to the onboard memory
- The burner proceeds to high-fire position **P2**. In the process, the display shows alternately **P2** and the speed
- By pressing  and  or  the speed can be changed in step sizes of 10 rpm within the limits predefined by the OEM (P2max, P2min)
- Press  to transfer the setting value to the onboard memory
- By pressing ESC (press  and  simultaneously) the setting process is ended and the burner changes to the operating position
- In the operating position, the output predefined by the external load controller applies

Note:

To store the settings in the PME... program module, a manual backup is required. Also see chapter *Manual backup* in LME7 Basic Documentation (P7105).



12.4.7 ... via the AZL2... operating unit



- Start the programming mode for the heating engineer
- Keep **A** and **F** depressed for <5 seconds. Display shows **Code**
- Enter the heating engineer's password via **+**, **-** and **i/reset**. Also see chapter *Entering the password* in LME7 Basic Documentation (P7105).
- Display shows **PARA** and then **400: SEt**. Confirm by pressing **i/reset**
- Display changes to **run**. Confirm by pressing **i/reset** to start the setting mode for low-fire (**P1**), ignition load (**P0**) and high-fire (**P2**)
- Heat request (temperature controller) ON
- Basic unit is started and runs through the startup phase. Then, the unit runs through the respective program phases in accordance with the program sequence and the numbers appear blinking
- The unit proceeds to the end of the prepurge phase (P30), goes to the start load position and then displays **P0** (ignition load speed). In the process, the display shows alternately **P0** (blinking) and the speed
- By pressing **A** (display changes to **0A** and the speed appears blinking) and pressing **+** or **-** the speed can be changed in step sizes of 10 rpm within the limits predefined by the OEM (**P0max**, **P0min**)

Note!

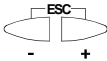

The setting value of P0 must be greater than the setting value of P1. The basic unit checks the setting values. If setting rules are violated, the unit goes to lockout and displays error message Loc: 225.

- Press **i/reset**
- The startup phase proceeds. The burner is ignited. The program proceeds to low-fire position **P1**. In the process, the display shows alternately **P1** (blinking) and the speed
- By pressing **A** (display changes to **1A** and the speed appears blinking) and pressing **+** or **-** the speed can be changed in step sizes of 10 rpm within the limits predefined by the OEM (P1max, P1min)
- Press **i/reset**
- Display changes briefly to **oP: P1**. The fan speed changes to the value for high-fire **P2** and the display changes to **P2** (blinking) to show the speed
- By pressing **A** (display changes to **2A** and the speed appears blinking) and pressing **+** or **-** the speed can be changed in step sizes of 10 rpm within the limits predefined by the OEM (P2max, P2min)
- Press **i/reset**
- Then, the display changes briefly to **oP: P1**. The fan speed changes to the value for low-fire **P1** and the display changes to **P1** (blinking) to show the speed

- From here, the low-fire speeds **P1** or high-fire speeds **P2** can be changed again as described above, or the setting process can be ended and the burner be brought into its operating position by pressing  several times (press  and  simultaneously)
- In the operating position, the output predefined by the external load controller applies



Note:

To store the settings in the PME... program module, a manual backup is required. Also see chapter *Manual backup* in LME7 Basic Documentation (P7105).

12.5 Overview of PWM fan parameters (value range refers to PME71.901)

Parameter-number	Designation	Value range		Step size *)	Conditions
		Min.	Max.		
403.00	Fan speed: Ignition load speed (P0)	800	9000	10 rpm	Factory setting 3000 rpm
403.01	Fan speed: Low-fire speed (P1)	400	9000	10 rpm	Factory setting 1200 rpm
403.02	Fan speed: High-fire speed (P2)	800	9000	10 rpm	Factory setting 5700 rpm
503.00	No-flame speeds PWM fan: Standby speed	0	9000	10 rpm	0 up to max. speed
503.01	No-flame speeds PWM fan: Prepurge speed / postpurge speed	800	9000	10 rpm	< max. speed
516.00	Limit speed ignition load P0: Min. limit	800	9000	10 rpm	P1min < P0min < P1max
516.01	Limit speed ignition load P0: Max. limit	800	9000	10 rpm	P0max < P1max
517.00	Limit speed low-fire P1: Min. limit	400	9000	10 rpm	---
517.01	Limit speed low-fire P1: Max. limit	800	9000	10 rpm	P1max < P2min
518.00	Limit speed high-fire P2: Min. limit	800	9000	10 rpm	P2min > P1max
518.01	Limit speed high-fire P2: Max. limit	800	9000	10 rpm	P2max > P2 min
519	Max. speed fan	3000	9000	10 rpm	Factory setting 5830 rpm
522	Ramp-up low-fire → high-fire	2.058	74.970	0.294 s	Factory setting approx. 15 s
523	Ramp-down high-fire → low-fire	2.058	74.970	0.294 s	Factory setting approx. 15 s
559	PWM mode 0 = open loop control 1 = PID control 2 = safety mode (PWM limits)	0	2	1	Factory setting 1 (control)
560	Mode: Pneumatic ratio control 0 = OFF 1 = PWM fan 2 = air damper actuator	0	2	1	Factory setting 1 (PWM fan)
644	Number of pulses per revolution	2	5	1	Factory setting 3 (Hall pulses/rev)
646	Settling time for speed assessment	1.029	2.058	0.147 s	Factory setting 2.1 seconds
650.00	Speed tolerance band: Speed shutdown	1	5	1%	Factory setting 1%
650.01	Speed tolerance band quick speed shutdown	1	10	1%	Factory setting 3%
658.00	PWM values fan: Start PWM	1	100	1%	Factory setting 25%
658.01	PWM values fan: Min. PWM	0	20	1%	Factory setting 0%
658.02	PWM values fan: Max. PWM	80	100	1%	Factory setting 100%
659.00	Ramp time of fan: Min. low-fire to high-fire	0	74.970	0.294 s	Factory setting 2.058 seconds
659.01	Ramp time of fan: Max. low-fire to high-fire	0	74.970	0.294 s	Factory setting 74.970 seconds
659.02	Ramp time of fan: Min. high-fire to low-fire	0	74.970	0.294 s	Factory setting 2.058 seconds
659.03	Ramp time of fan: Max. high-fire to low-fire	0	74.970	0.294 s	Factory setting 74.970 seconds
660	Tolerance time speed deviation	0	37.485	0.147 s	Factory setting 4.998 seconds
674	Neutral band (permitted control offset)	0	255	1 rpm	Factory setting 40 rpm
675.00	PWM: Min. PWM with prepurging, SEC	0	100	1%	Factory setting 86%
675.01	PWM: Max. PWM with ignition load, SEC	0	100	1%	Factory setting 34%
676	Gain factor speed control	0	255	1	Factory setting 112

Parameter-number	Designation	Value range		Step size *)	Conditions
		Min.	Max.		
677	Integral action time speed control	0	37.485	0.147 s	Factory setting 0.441 s
678	Derivative action time speed control	0	37.485	0.147 s	Factory setting 0 seconds
679.00	Time constant Pt1 speed control: Lower speed range high-fire to low-fire	0	37.485	0.147 s	Factory setting 6.027 seconds
679.01	Time constant Pt1 speed control: Medium speed range high-fire to low-fire	0	37.485	0.147 s	Factory setting 6.027 seconds
679.02	Time constant Pt1 speed control: Upper speed range high-fire to low-fire	0	37.485	0.147 s	Factory setting 6.027 seconds
679.03	Time constant Pt1 speed control: Entire speed range low-fire to high-fire	0	37.485	0.147 s	Factory setting 6.027 seconds
680.00	Speed range for Pt1 time constant: Threshold upper speed range	800	9000	10 rpm	Factory setting 4000 rpm
680.01	Speed range for Pt1 time constant: Threshold lower speed range	800	9000	10 rpm	Factory setting 2000 rpm
920	Current PWM signal fan	0	100	1%	Service parameter







*) Step size of speeds when making the settings via PC software ACS410: 1 rpm

13 Error code list

Error code		Clear text	Possible cause
AZL2...	7-segment		
Loc: 2	Loc 2	No establishment of flame at the end of safety time	<ul style="list-style-type: none"> - Faulty or soiled fuel valves - Faulty or soiled flame detector - Poor adjustment of burner, no fuel - Faulty ignition equipment
Loc: 3	Loc 3	Air pressure faulty (air pressure switch welded in no-load position, decrease to specified time (air pressure switch flame-on response time)	Air pressure switch faulty <ul style="list-style-type: none"> - Loss of air pressure signal after specified time - Air pressure switch has welded in no-load position
Loc: 4	Loc 4	Extraneous light	Extraneous light during burner startup
Loc: 5	Loc 5	Air pressure faulty, air pressure switch welded in working position	Time supervision air pressure switch <ul style="list-style-type: none"> - Air pressure switch has welded in working position
Loc: 7	Loc 7	Loss of flame	Too many losses of flame during operation (limitation of repetitions) <ul style="list-style-type: none"> - Faulty or soiled fuel valves - Faulty or soiled flame detector - Poor adjustment of burner
Loc: 10	Loc 10	Error not relatable (application), internal error	Wiring error or internal error, output contacts, other faults
Loc: 12	Loc 12	Valve proving	Fuel valve 1 leak
Loc: 13	Loc 13	Valve proving	Fuel valve 2 leak
Loc: 14	Loc 14	POC error	Error valve closure control POC
Loc: 22	Loc 22	Safety loop open	<ul style="list-style-type: none"> - Gas pressure switch-max open - Safety limit thermostat cut out
Loc: 60	Loc 60	Analog power source 4...20 mA, I <4 mA	Wire breakage
Loc: 83	Loc 83	Faulty PWM fan	<ul style="list-style-type: none"> - PWM fan does not reach the target speed within the preset period of time, or - After reaching the target speed, the PWM fan leaves the tolerance band again (parameter 650) for a time exceeding the tolerance time speed deviation (parameter 660)
Loc: 138	Loc 138	Restore process successful	Restore process successful
Loc: 139	Loc 139	No program module detected	No program module plugged in
Loc: 167	Loc 167	Manual locking	Manual locking
Loc: 206	Loc 206	AZL2... incompatible	Use the latest version
Loc: 225	Loc 225	Faulty PWM fan	<ul style="list-style-type: none"> - Fan speed dropped below the minimum prepurge PWM (parameter 675.00) after reaching the prepurge speed, or - After reaching the ignition load speed, the maximum ignition load PWM (parameter 675.01) was exceeded
Loc: 226	Loc 226	Faulty PWM fan	Parameterization error: <ul style="list-style-type: none"> - Speed low-fire > speed high-fire, or - Low-fire = 0 rpm, or - Maximum speed = 0 rpm
Loc: 227	Loc 227	Faulty PWM fan	One or several parameters violate the minimum/maximum limit

Error code		Clear text	Possible cause
AZL2...	7-segment		
rSt Er1	rSt Er1	Error in compatibility program module to basic unit during restore process	- Program sequence of program module does not match the basic unit
rSt Er2	rSt Er2	Error in compatibility program module to basic unit during restore process	- Hardware of basic unit does not match the program module
rSt Er3	rSt Er3	Error during restore process	- Program module faulty - Program module removed during restore process
bAC Er3	bAC Er3	Fault of compatibility program module to basic unit during backup process	Program sequence of program module does not match the basic unit
Err PrC	Err PrC	Fault of program module	- Error in data content of program module - No program module fitted

14 Legend

AL	Alarm device
Dbr...	Wire link
	Lockout reset button (info button)
 /reset (EK1)	
EK2	Remote lockout reset button
FSV	Flame signal amplifier
ION	Ionization probe
K...	Relay contact
LED	3-color signal lamp
LP	Air pressure switch
LR	Load controller
LR-OPEN	Load controller OPEN position
LR-CLOSED	Load controller CLOSED position
M	Fan motor
NT	Power supply unit
P LT	Pressure switch - valve proving
Pmax	Pressure switch-max
Pmin	Pressure switch-min
POC	Valve closure control (proof of closure)
	PWM motor power supply
PWM	
QRA...	Flame sensor
R	Control thermostat or pressurestat
SK	Safety Loop
SV	Safety valve
V1	Fuel valve
V2	Fuel valve
Z	Ignition transformer
	Input/output signal 1 (ON)
	Input/output signal 2 (OFF)
	Permissible input signal 1 (ON) or 0 (OFF)
*1	Valve proving during prepurging, if - parameter 241.00 = 1 and parameter 241.02 = 1 or - parameter 241.00 = 1 and parameter 241.01 = 0 or - parameter 234 (postpurge time) = 0 seconds
*2	Valve proving during postpurging, if - parameter 241.00 = 1 and parameter 241.02 = 1 or - parameter 241.00 = 1 and parameter 241.01 = 1 and - parameter 234 (postpurge time) >0 seconds

15 List of figures

Figure 1: Program sequence	5
Figure 2: Fuel train gas direct ignition (G), 1-stage	7
Figure 3: Fuel train gas direct ignition (G), 1-stage, with valve proving	7
Fig. 4: Valve proving with separate pressure switch	8
Figure 5: Inputs and outputs / internal connection diagram.....	13