



ACVATIX™

## Electromotoric rotary actuators for butterfly or slipper valves

**SAL..**

with 90° rotary angle

- 
- SAL31.. Operating voltage AC 230 V, 3-position control signal
  - SAL61.. Operating voltage AC/DC 24 V, control signal 0...10 V,  
4...20 mA, 0...1000 Ω
  - SAL81.. Operating voltage AC/DC 24 V, 3-position control signal
  - SAL61.. Position feedback, override control
  - For direct mounting on butterfly or slipper valves; no adjustments required
  - Manual adjuster, position indicator and status indication with LED
  - Optional functions with auxiliary switches, potentiometer

### Use

---

For the operation of Siemens butterfly and slipper valves, types VKF41.., VKF46.., and VBF21.. as control or shutoff valves in heating, ventilation and air conditioning systems.

## Type summary

Product no.	Stock no.	Angular rotation	Torque	Operating voltage	Positioning signal	Positioning time	LED	Manual adjuster	Extra functions		
SAL31.00T10	S55162-A108	90°	10 Nm	AC 230 V	3-position	120 s	-	Push and fix	-		
SAL31.00T20	S55162-A110		20 Nm								
SAL31.00T40	S55162-A111		40 Nm								
SAL31.03T10	S55162-A109		10 Nm	AC/DC 24 V	DC 0...10 V DC 4...20 mA 0...1000 Ω	30 s				✓	Position feedback, forced control
SAL61.00T10	S55162-A100		20 Nm								
SAL61.00T20	S55162-A102		40 Nm								
SAL61.00T40	S55162-A103		40 Nm	10 Nm	3-position	120 s			-	-	
SAL61.03T10	S55162-A101		20 Nm								
SAL81.00T10	S55162-A104		40 Nm								
SAL81.00T20	S55162-A106		20 Nm	10 Nm	3-position	120 s			-	-	
SAL81.00T40	S55162-A107		40 Nm								
SAL81.03T10	S55162-A105		10 Nm			30 s					

## Electrical accessories

Product no.	Auxiliary switch ASC10.51	Potentiometer ASZ7.5	Function module AZX61.1
Stock no.	S55845-Z103	S55845-Z106	S55845-Z107
	Max. 2 in total		
SAL31..	Max. 2	Max. 1	-
SAL61..	Max. 2	-	Max. 1 AZX61.1
SAL81..		Max. 1	-

Note: ASZ7.5

For the combination SIMATIC S5/S7 and position feedback message, we recommend actuators with DC 0...9.8 V feedback signals.

The signal peaks that occur in the potentiometer ASZ7.5 may result in error messages on Siemens SIMATIC.

This is not the case when combined with Siemens HVAC controllers.

The reason is that SIMATIC has a higher resolution and faster response time.

## Mechanical accessories

Product no.	Weather shield ASK39.1	Mounting set		
		ASK31N for VBF21..	ASK33N for VKF41..	ASK35N for VKF45.. <sup>1)</sup>
Stock no.	S55845-Z109	S55845-Z100	S55845-Z101	S55845-Z102
SAL..T10	Max. 1	✓	✓	-
SAL..T20		-	-	DN40...DN65
SAL..T40		-	DN150...DN200	DN80...DN200

<sup>1)</sup> Type VKF45.. was replaced by type VKF46.. in the year 2000

## Ordering



### Example

Product no.	Stock no.	Description	Quantity
SAL31.00T10	S55162-A108	Rotary actuator	1
ASZ7.5	S55845-Z106	Potentiometer	1

### Delivery

Actuators, valves and accessories are supplied in individual packs.

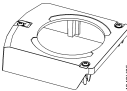
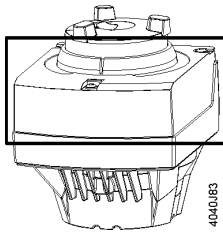
## Spare parts

<b>Stock number</b> 8000060844	<b>Housing cover</b> 		
	<b>2 adapters</b> 		1 pc. 14 mm 1 pc. 11 mm
	<b>4 screws</b> 		2 pcs. M5 x 20 mm 2 pcs. M6 x 20 mm

## Combinations

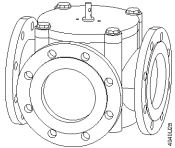
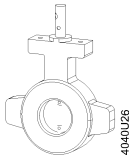
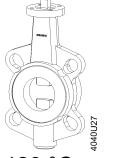
SAL..				Angular rotation	Torque	SAL..T10	SAL..T20	SAL..T40			
						10 Nm	20 Nm	40 Nm			
<b>Slipper valves</b>	<b>Data Sheet</b>	<b>Valve type <sup>1)</sup></b>	<b>DN</b>	<b>k<sub>vs</sub></b> [m <sup>3</sup> /h]	<b>Mounting set</b>	<b>Δp<sub>max</sub></b> [kPa]					
<b>PN6</b>  1 °C... 120 °C	N4241	VBF21.40	40	25	-	- <sup>1)</sup>	-	-			
		VBF21.50	50	40	-	- <sup>1)</sup>					
		VBF21.65	65	63	ASK31N	30					
		VBF21.80	80	100	ASK31N						
		VBF21.100	100	160	ASK31N						
		VBF21.125	125	550	ASK31N						
		VBF21.150	150	820	ASK31N						
<b>Butterfly valves</b>						<b>Δp<sub>s</sub></b> [kPa]					
<b>PN16</b>  -10 °C... 120 °C	N4131	VKF41.40	40	50	ASK33N	500	-	-			
		VKF41.50	50	80	ASK33N						
		VKF41.65	65	200	ASK33N						
		VKF41.80	80	400	ASK33N						
		VKF41.100	100	760	ASK33N				300		
		VKF41.125	125	1'000	ASK33N						
		VKF41.150	150	2'100	ASK33N					250	-
		VKF41.200	200	4'000	ASK33N				125	-	300
<b>PN16</b>  -10 °C.... 120 °C	N4136	VKF46.40	40	50	-	-	1'600	-			
		VKF46.50	50	85	-						
		VKF46.65	65	215	-						
		VKF46.80	80	420	-						
		VKF46.100	100	800	-				-	1600	
		VKF46.125	125	1'010	-					1200	
										800	

1) SAL..T10 rotary actuators only fit on VBF21.., DN65...150. For VBF21.., DN40/50 use SQK34.., SQK84.. (data sheet N4508) or SQK33.00 (data sheet N4506) rotary actuators.

## Product documentation

Detailed information about the New Generation actuators can be found in the basic documentation "Electromotoric actuators SAX.., SAL.." (CE1P4040en).

## Notes

### Engineering

SAL 31.. / SAL81..

3-position actuators must have their own specific controller, refer to "Connection Diagrams" (page 9).

SAL61..

Up to 10 actuators can drive in parallel on a controller output with a rating of 1 mA. Modulating actuators have an input impedance of 100 kΩ.

**Mounting**

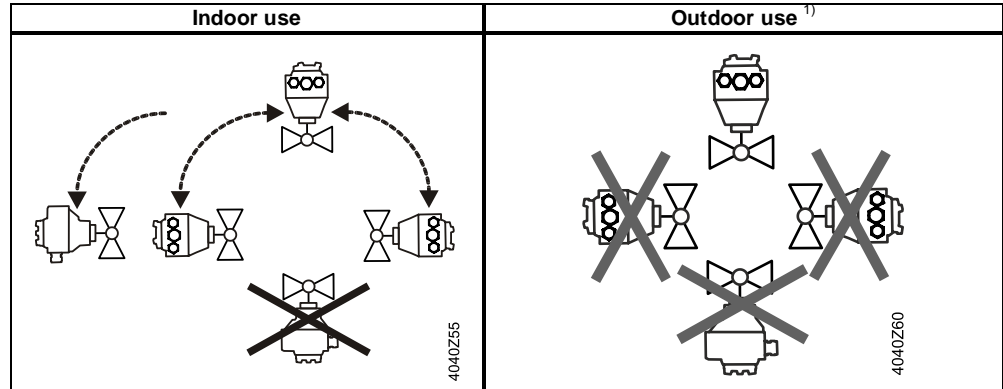

<sup>1)</sup> Only in connection with weather shield ASK39.1

**Maintenance**

The rotary actuators are maintenance-free.

**Disposal**

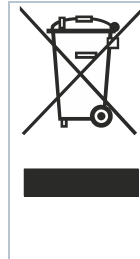

The device is considered electrical and electronic equipment for disposal in terms of the applicable European Directive and may not be disposed of as domestic garbage.

- Dispose of the device through channels provided for this purpose.
- Comply with all local and currently applicable laws and regulations.

**Warranty**

The engineering data specified in chapter "Combinations" (page 3) are only guaranteed in connection with the Siemens valves listed.

**Note**

**When using the actuators in connection with slipper valves of other manufacture, correct functioning must be ensured by the user, and Siemens will assume no responsibility. The use of the rotary actuators SAL..T10 with butterfly valves is only permitted for the Siemens Series VKF41..**

## Technical Data

		SAL..
<b>Power supply</b>	Operating voltage SAL31.. SAL61.. SAL81..	AC 230 V ±15% AC 24 V ± 20% / DC 24 V + 20% / -15% (SELV) AC 24 V ±20% / DC 24 V + 20 % / -15% (SELV)
	Frequency	45...65 Hz
	External supply line protection (EU)	<ul style="list-style-type: none"> <li>Fuse slow 6...10 A</li> <li>Circuit breaker max. 13 A, Characteristic B, C, D according to EN 60898</li> <li>Power source with current limitation of max. 10 A</li> </ul>
	Power consumption at 50 Hz SAL31.00T10 Rotary actuator turns SAL31.00T20 Rotary actuator turns SAL31.00T40 Rotary actuator turns SAL31.03T10 Rotary actuator turns SAL61.00T10 Rotary actuator turns SAL61.00T20 Rotary actuator turns SAL61.00T40 Rotary actuator turns SAL61.03T10 Rotary actuator turns SAL81.00T10 Rotary actuator turns SAL81.00T20 Rotary actuator turns SAL81.00T40 Rotary actuator turns SAL81.03T10 Rotary actuator turns	3.5 VA / 2 W 4.5 VA / 2.75 W 7 VA / 4 W 5,5 VA / 3.25 W 5 VA / 2.5 W 6 VA / 2.75 W 9 VA / 4 W 7.5 VA / 3.5 W 3 VA / 2 W 4 VA / 2.75 W 6 VA / 3.75 W 5 VA / 3.5 W
<b>Function data</b>	Positioning times (with spec. nominal angular rotation) SAL31.00.., SAL61.00.., SAL81.00 SAL31.03T10, SAL61.03T10 SAL81.03T10	120 s 30 s
	Torque SAL..T10 SAL..T20 SAL..T40	10 Nm running / min. 4 Nm holding 20 Nm running / min. 14 Nm holding 40 Nm running / min. 14 Nm holding
	Rotary angle Permissible medium temperature (valve fitted)	90° -10...120 °C
<b>Signal inputs</b>	Positioning signal "Y" SAL31.., SAL81.. SAL31.. Voltage SAL81.. Voltage SAL61.. (DC 0...10 V) Current draw Input impedance SAL61.. (DC 4...20 mA) Current draw Input impedance	3-position AC 230 V ±15% AC 24 V ± 20 % / DC 24 V + 20 % / -15% ≤ 0.1 mA ≥100 kΩ DC 4...20 mA ± 1% ≤500 Ω
<b>Parallel operation</b>	SAL61..	≤ 10 (depending on controller output)
<b>Forced control</b>	Positioning signal "Z" SAL61.. R = 0...1000 Z connected to G Z connected to G0 Voltage Current draw	R = 0...1000 Ω, G, G0 Stroke / rotation proportional to R 90° <sup>1)</sup> 0° <sup>1)</sup> Max. AC 24 V ± 20% Max. DC 24 V + 20% / -15% ≤ 0.1 mA
<b>Position feedback</b>	Position feedback U SAL61.. Load impedance Load	DC 0...10 V >10 kΩ res. Max. 1 mA
<b>Connecting cable</b>	Wire cross-sectional areas	0.75...1.5 mm <sup>2</sup> , AWG 20...16 <sup>2)</sup>
Connecting cable	Cable entries	2 entries ∅ 20.5 mm (for M20) 1 entry ∅ 25.5 mm (for M25)
<b>Degree of protection</b>	Housing from vertical to horizontal	IP54 as per EN 60529 <sup>3)</sup>
	Insulation class SAL31.. AC 230 V SAL61.. AC / DC 24 V SAL81.. AC / DC 24 V	As per EN 60730 II III III
<b>Environmental conditions</b>	Operation Climatic conditions Mounting location Temperature Humidity (noncondensing)	IEC 60721-3-3 Class 3K5 Indoors (weather-protected) -15...55 °C 5...95 % r.h.
	Transport	IEC 60721-3-2

	Climatic conditions Temperature Humidity	Class 2K3 -25...70 °C <95 % r.h.
	Storage Climatic conditions Temperature Humidity	IEC 60721-3-1 Class 1K3 -15...55 °C 5...95 % r.h.
	Max. media temperature when mounted on valve	120 °C
<b>Norms and Directives</b>	Product standard	EN 60730-x
	Electromagnetic compatibility (Application)	For residential, commercial and industrial environments
	EU Conformity (CE)	CE1T4502X1 <sup>4)</sup>
	RCM Conformity	A5W00002575 <sup>4)</sup>
	EAC Conformity	Eurasia Conformity for all SAL..
	UL, cUL AC 230 V AC / DC 24 V	- UL 873 <a href="http://ul.com/database">http://ul.com/database</a>
<b>Environmental compatibility</b>		The product environmental declaration CE1E4502en <sup>4)</sup> contains data on environmentally compatible product design and assessments (RoHS compliance, materials composition, packaging, environmental benefit, disposal).
<b>Dimensions</b>	-	See "Dimensions" (page 10)
<b>Weight</b>	Excl. packaging	See "Dimensions" (page 10)

<sup>1)</sup> Observe acting direction of DIL switches

<sup>2)</sup> AWG = American wire gauge

<sup>3)</sup> Also with weather shield ASK39.1

<sup>4)</sup> The documents can be downloaded from <http://siemens.com/bt/download>.

<b>Accessories<sup>1)</sup></b>	Potentiometer ASZ7.5	Voltage DC 10 V
	Auxiliary switch ASC10.51 External supply line protection US installation, UL & cUL	Current rating <4 mA Switching capacity AC 24...230 V, 6 (2) A, floating See section power supply AC 24 V class 2, 5 A general purpose

<sup>1)</sup> UL recognized component



## Connection Diagrams

### Internal Diagrams

SAL31..

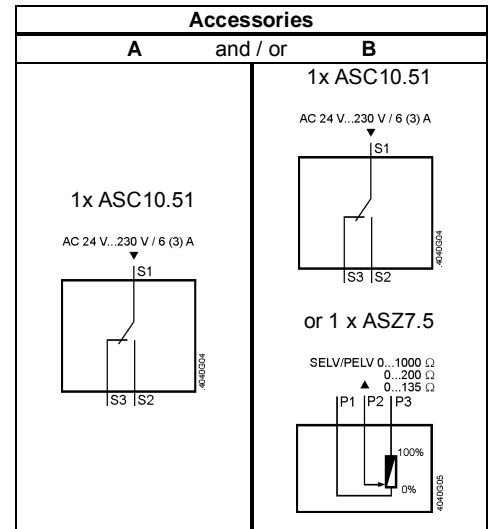
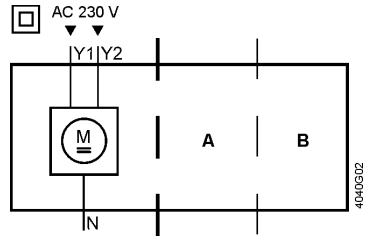

SAL61..

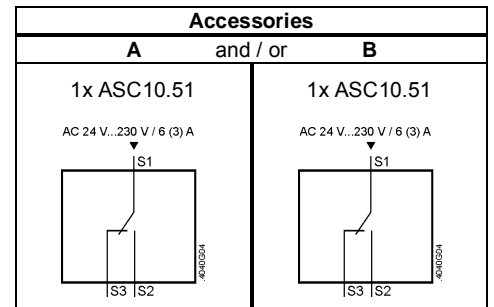
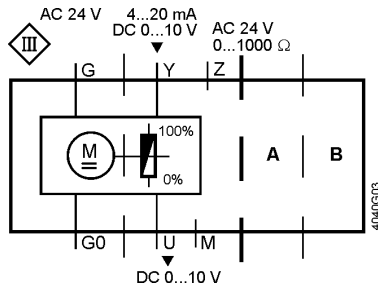

SAL81..

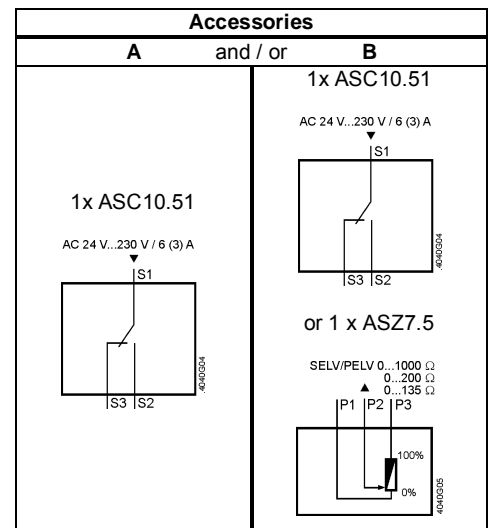
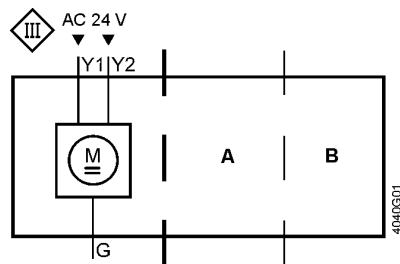

## Connection terminals

SAL31..

AC 230 V, 3-position

- N** — Sytem neutral (SN)
- Y1** — Positioning signal (actuator's spindle turns clockwise)
- Y2** — Positioning signal (actuator's spindle turns counter-clockwise)

SAL61..

AC/DC 24 V, DC 0...10 V / 4...20 mA / 0...1000 Ω

- G0** — Sytem neutral (SN)
- G** — Sytem potential (SP)
- Y** — Positioning signal for DC 0...10 V / 4...20 mA
- M** — Measuring neutral
- U** — Position feedback DC 0...10 V – (reference potential is M measuring neutral)
- Z** — Positioning signal forced control AC/DC ≤ 24 V, 0...1000 Ω

SAL81..

AC/DC 24 V, 3-position

- G** — Sytem potential (SP)
- Y1** — Positioning signal (actuator's spindle turns clockwise)
- Y2** — Positioning signal (actuator's spindle turns counter-clockwise)

## Connection terminals accessories

Auxiliary switch  
ASC10.51

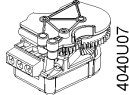

Adjustable switching points, AC 24...230 V

- 1** — System potential (SP)
- 2** — Closing (actuator's spindle turns clockwise)
- 3** — Opening (actuator's spindle turns clockwise)

AC 24 V...230 V / 6 (3) A

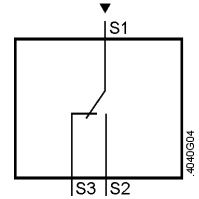

Potentiometer  
ASZ7.5/..

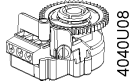

Adjustment of zero point, DC 10 V

- 1** — Measuring neutral
  - 2** — 0...x Ω
  - 3** — x...0 Ω
- x = 135 Ω, 200 Ω, 1000 Ω

SELV/PELV 0...1000 Ω  
0...200 Ω  
0...135 Ω

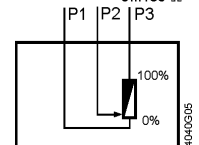



## Connection Diagrams

SAL31..

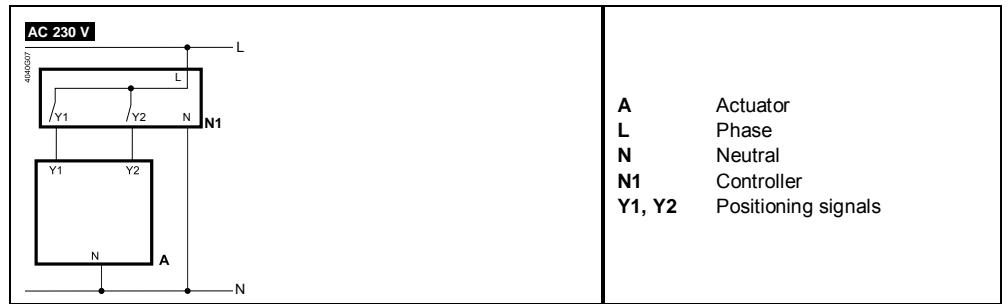

SAL61..

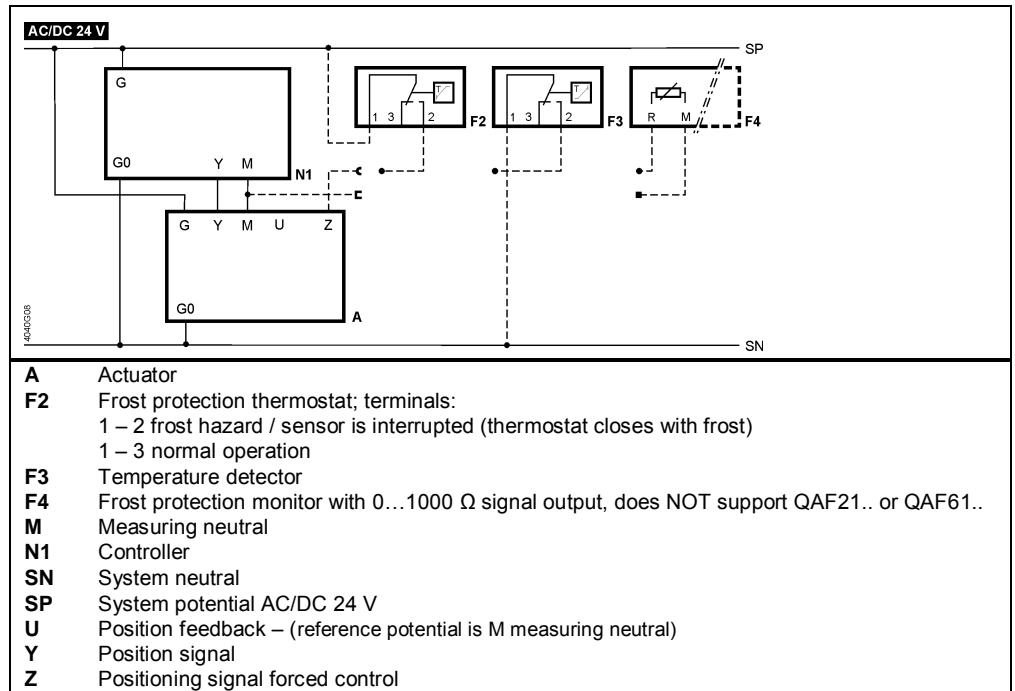

SAL81..

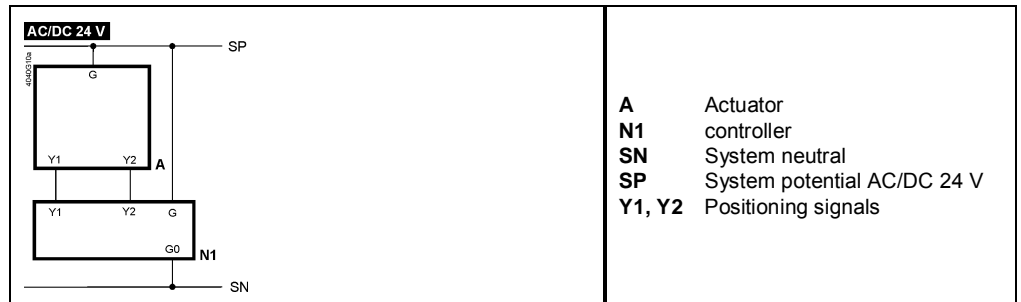

# Dimensions

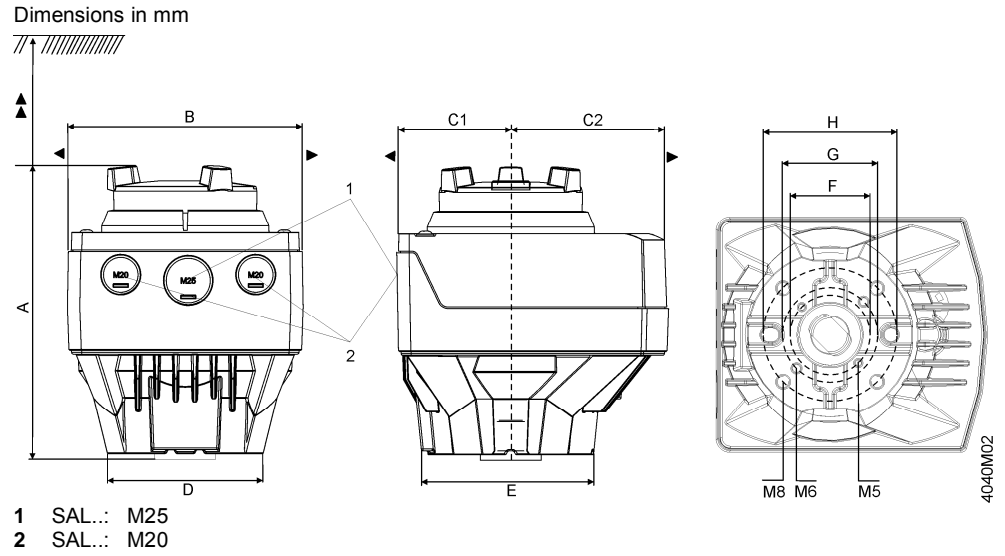

Type	A	B	C	C1	C2	D	E	F	G	H	▶	▶▶	kg		
													SAL..T10	SAL..T20	SAL..T40
SAL..	160	124	150	68	82	82	88	42	50	70	100	200	1.475	1.600	1.625
With ASK39.1	+25	154	300	200	100	-	-	-	-	-	-	-	1.710	1.835	1.860

## With mounting set ASK3..N

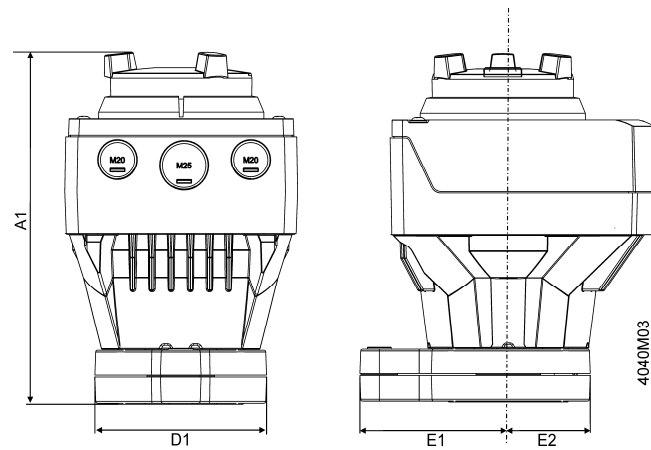

Type	A1	D1	E1	E2
SAL.. with ASK3..N	188	88	80	44
With ASK39.1	+25	-	-	-

## Revision numbers

---

Product no.	Valid from rev. no.
SAL31.00T10	..E
SAL31.00T20	..D
SAL31.00T40	..B
SAL31.03T10	..E
SAL61.00T10	..E
SAL61.00T20	..D
SAL61.00T40	..B
SAL61.03T10	..E
SAL81.00T10	..E
SAL81.00T20	..D
SAL81.00T40	..B
SAL81.03T10	..E

Issued by  
Siemens Switzerland Ltd  
Building Technologies Division  
International Headquarters  
Theilerstrasse 1a  
6300 Zug  
Switzerland  
Tel. +41 58-724 24 24  
[www.siemens.com/buildingtechnologies](http://www.siemens.com/buildingtechnologies)

© Siemens Switzerland Ltd, 2011  
Technical specifications and availability subject to change without notice.