

**RWD68 Universal Controller  
Application 70**

Room temperature control  
Chilled water control valve  
Two speed fan

- Control (P or PI)**
- Room temperature control**
- Proportional control ( 0..10Vdc ) of the chilled water valve.**
- Digital output to energise second stage of supply fan**
- Optional day / night set point adjustment .**

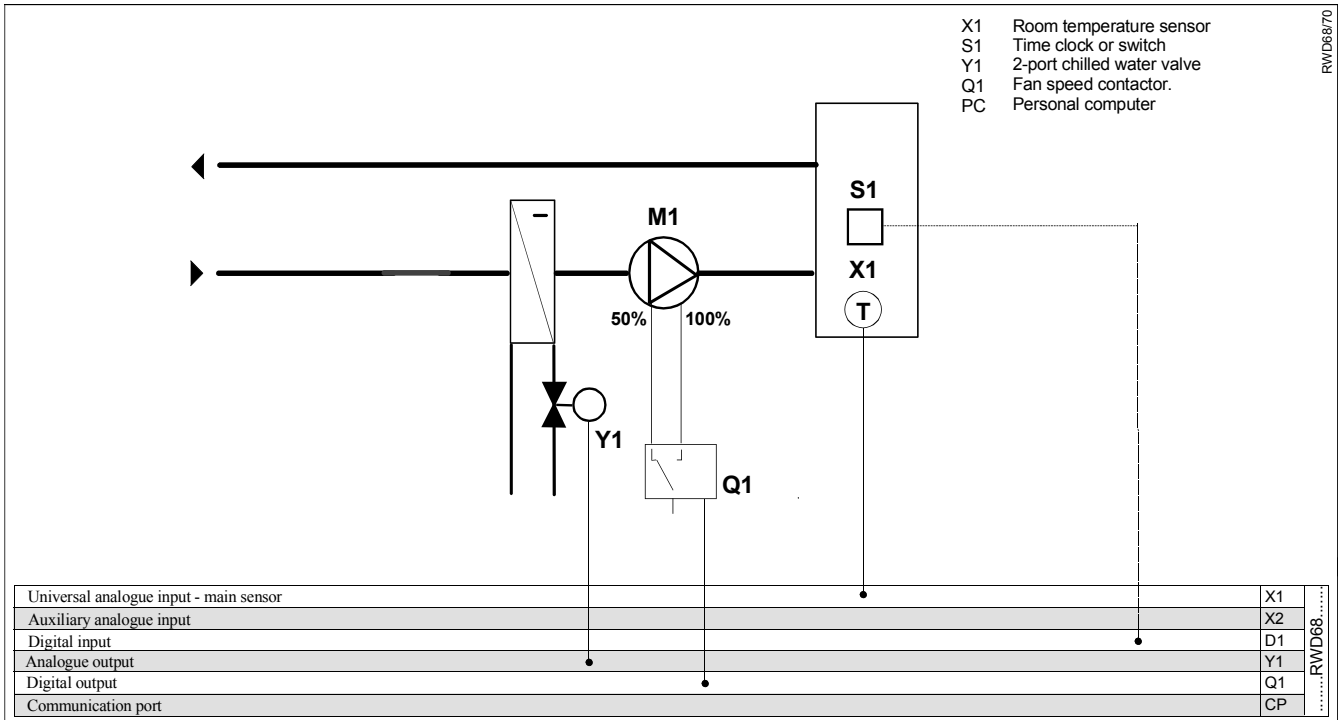

**Supplemental features**

**Control**

- Room temperature sensor can be selected as Ni1000, Pt1000, or active sensor.
- Adjustable differential of digital output Q1.
- Adjustable proportional band of analogue output Y1.
- Integral action function selection and adjustment for output Y1.
- 24Vac controller supply voltage
- 0..10Vdc modulating control valve

**Operating modes**

- Day / night set points can be selected via time clock or switch.
- Independent mode for the two cooling outputs, meaning that the digital output on and off settings are set outside the analogue output proportional band.

**Description of operation**

The temperature sensor senses the room conditions and on a rise in temperature the RWD68 via Y1 analogue output modulates the chilled water control valve as determined by the cooling set point and proportional band settings.

When the chilled water valve is fully open, on a further increase in temperature the Q1 digital output energises the fan speed contactor to switch the fan from 50% to 100% fan speed, as determined by the Q1 ON setting.

**Function diagram**

Cooling sequences

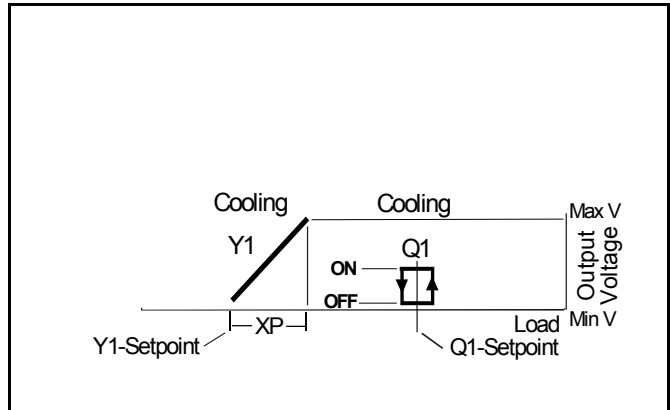

**Connection diagram**

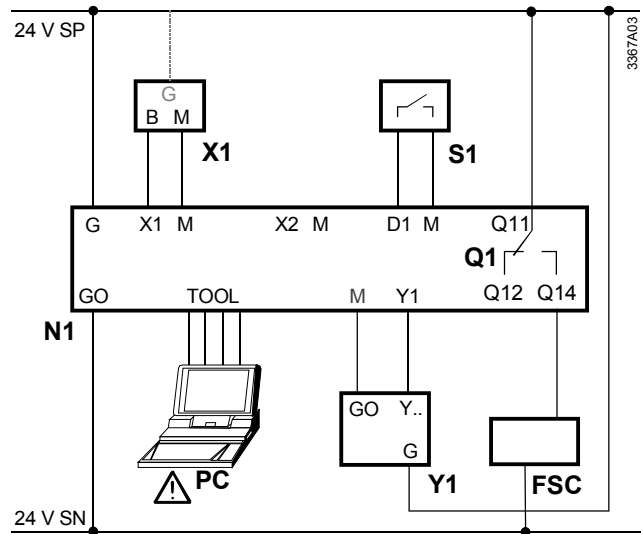



**RWD68**





- N1 RWD68 controller
- X1 Main temperature sensor
- S1 Time clock or switch
- Q1 Potential-free relay contacts for on / off control
- Y1 Valve actuator with 0..10Vdc input
- FSC Fan speed contactor
- PC Personal computer

**Main Display**











The main display shows ,

- a) Whether Q1 is On or Off (  = off,  = on )
- b) Y1 output in Volts dc. (0..10V = 0..100% range)
- c) Whether day or night set point is selected. (☐ = day, ◐ = night)
- d) X1 value ( room temperature) in ° C.

Other displays are available by pressing the + button, and the various displays are listed below in sequence from the main display.

On entering any of the four set point displays, the setpoint on display can be adjusted by pushing the  enter/save button, increase value by pressing the  + button or decrease the value by pressing the  - button, and when the required value is reached, press the  enter/save button to save the new value.

The alternative displays return to the main display after 20 seconds duration.

Press buttons	Action	Current display	Selected display	Selected display comments
	Push + button	Q1 Y1 ☐ X1	Y1 SP – c ☐ 28.0c	Y1 cooling day set point.
	Push + button	Y1 SP – c ☐ 28.0c	Q1 SP – c ☐ 32.0c	Q1 cooling day set point.
	Push + button	Q1 SP – c ◐ 32.0c	Y1 SP – c ◐ 32.0c	Y1 cooling night set point.
	Push + button	Y1 SP – c ◐ 32.0c	Q1 SP – c ◐ 36.0c	Q1 cooling night set point.
	Push + button	Q1 SP – c ◐ 36.0c	X1 18.0c	X1 - main temperature sensor reading
	Push + button	X1 18.0c	Y1 5.0	Y1 – heating analogue output value in Vdc to one decimal point
	Push + button	Y1 5.0	Q1 OFF	Q1 – cooling digital output, display on or off.
	Push + button	Q1 OFF	 70	Control sequence diagram and application number display.
	Push + button	 70	Q1 Y1 ☐ X1	Back to main display

Values shown are either default values or nominated for information only