

**RWD68 Universal Controller**

Room temperature control  
Hot water control valve  
DX cooling

**Application 55  
Cascade control**

- Control (P or PI)
- Room temperature control
- Proportional control ( 0..10Vdc ) of the hot water valve.
- On/off control of DX cooling (refrigeration package unit)
- Cascade control.
- Optional day / night set point adjustment .

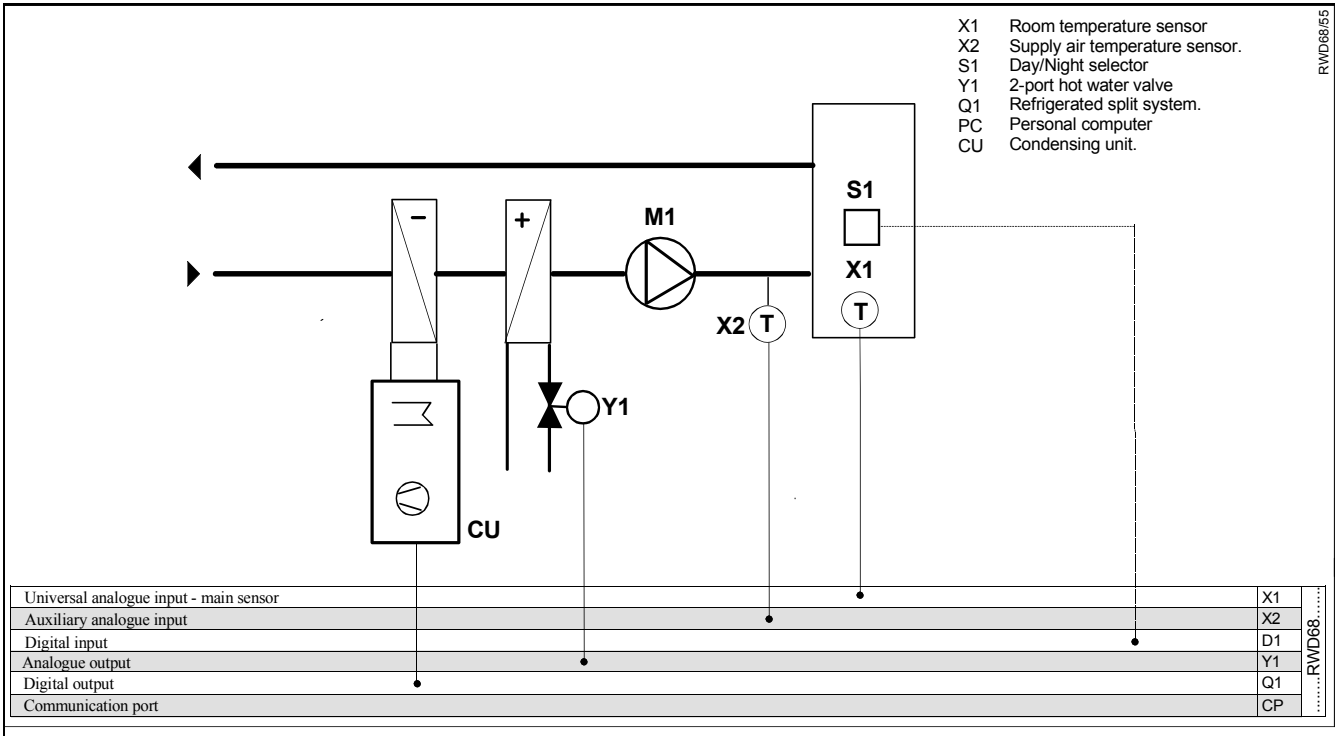

**Supplemental features**

**Control**

- Room temperature sensor can be selected as Ni1000, Pt1000, or active sensor.
- Adjustable dead zone with separate heating and cooling set points.
- Adjustable differential of digital output Q1.
- Adjustable proportional band of analogue output Y1.
- Integral action function selection and adjustment.
- Duct temperature sensor can be selected as Ni1000, Pt1000, or active sensor.
- Cascade control of the supply air by the room temperature sensor.

**Operating modes**

- Day / night set points can be selected via time clock or switch.

**Safety functions**

- Safety functions are built into the condensing unit of the refrigerated split system.

**Description of operation**

Cascade control is where deviation of room temperature from setpoint adjusts the control point of the leaving air temperature controlling heating and cooling in sequence.

On a fall in room temperature, the leaving air temperature control point is increased and heating is provided via Y1 analogue output modulating the hot water valve, as determined by the heating set point and proportional band settings.

On a rise in room temperature, the leaving air temperature control point is decreased and cooling is provided via the Q1 digital output switching on and off the condensing unit as determined by the cooling set point and differential settings.

Heating and cooling sequences

**Function diagram**

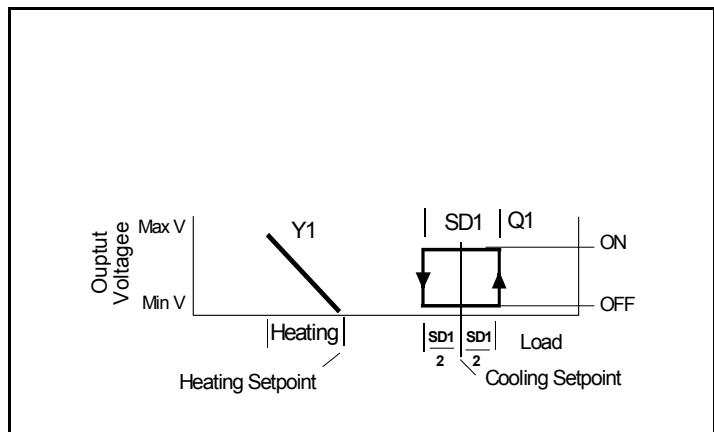

**Connection diagram**

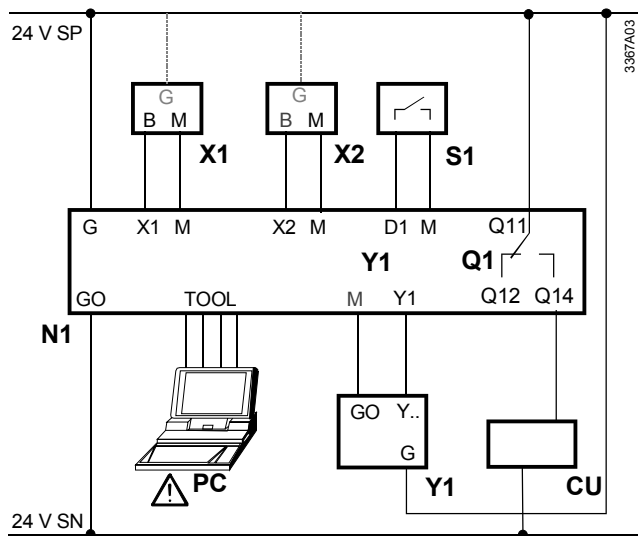



**RWD68**



- N1 RWD68 controllers
- X1 Main temperature sensor
- X2 Supply air temperature sensor.
- S1 Time clock or switch for day/night setpoint select
- Q1 Potential-free relay contacts for 2-position
- Y1 Heating control valve
- CU Condensing unit.
- PC Personal computer

## Main Display



The main display shows ,

- Whether Q1 is On or Off (  = off,  = on )
- Y1 output in Volts dc. (0..10V = 0..100% range)
- Whether day or night set point is selected. (  $\boxtimes$  = day,  $\text{C}$  = night)
- X1 value ( room temperature) in ° C.

Other displays are available by pressing the + button, and the various displays are listed below in sequence from the main display.

On entering any of the four set point displays, the setpoint on display can be adjusted by pushing the  enter/save button, increase value by pressing the  $\blacktriangle$ + button or decrease the value by pressing the  $\blacktriangledown$ - button, and when the required value is reached, press the  enter/save button to save the new value.

The alternative displays return to the main display after 20 seconds.

Press buttons	Action	Current display	Selected display	Selected display comments.
$\blacktriangle$	Push + button	Q1 Y1 $\boxtimes$ X1	Y1 SP – h $\boxtimes$ 25.0c	Y1 heating day set point.
$\blacktriangle$	Push + button	Y1 SP – h $\boxtimes$ 25.0c	Q1 SP – c $\boxtimes$ 28.0c	Q1 cooling day set point.
$\blacktriangle$	Push + button	Q1 SP – c $\boxtimes$ 28.0c	Y1 SP – h $\text{C}$ 16.0c	Y1 heating night set point.
$\blacktriangle$	Push + button	Y1 SP – h $\text{C}$ 16.0c	Q1 SP – c $\text{C}$ 32.0c	Q1 cooling night set point.
$\blacktriangle$	Push + button	Q1 SP – c $\text{C}$ 32.0c	X1 18.0c	X1 - main temperature sensor reading
$\blacktriangle$	Push + button	X1 18.0c	X2 19.0 C	X2 – auxiliary temperature sensor reading
$\blacktriangle$	Push + button	<b>X2 19.0 C</b>	Y1 5.0	Y1 – heating analogue output value in Vdc to one decimal point
$\blacktriangle$	Push + button	<b>Y1 5.0</b>	Q1 OFF	Q1 – cooling digital output, display shows if relay is on or off.
$\blacktriangle$	Push + button	<b>Q1 OFF</b>	<b>CASC</b>  <b>55</b>	Control sequence diagram and application number display.
$\blacktriangle$	Push + button	<b>CASC</b>  <b>55</b>	Q1 Y1 $\boxtimes$ X1	Back to main display.

Values shown are either default values or nominated for information only

## Alternatives

- 1) Modulating hot water valve and two position chilled water valve.