

RWD32 Universal Controller
Application 50

Room temperature control
 Chilled water control valve
 Chilled water pump output

- Control two stage(2 position)
- Room temperature control
- 2 position control of the chilled water control valve
- Digital output to energise chilled water pump (dependent)
- Optional day / night set point adjustment .

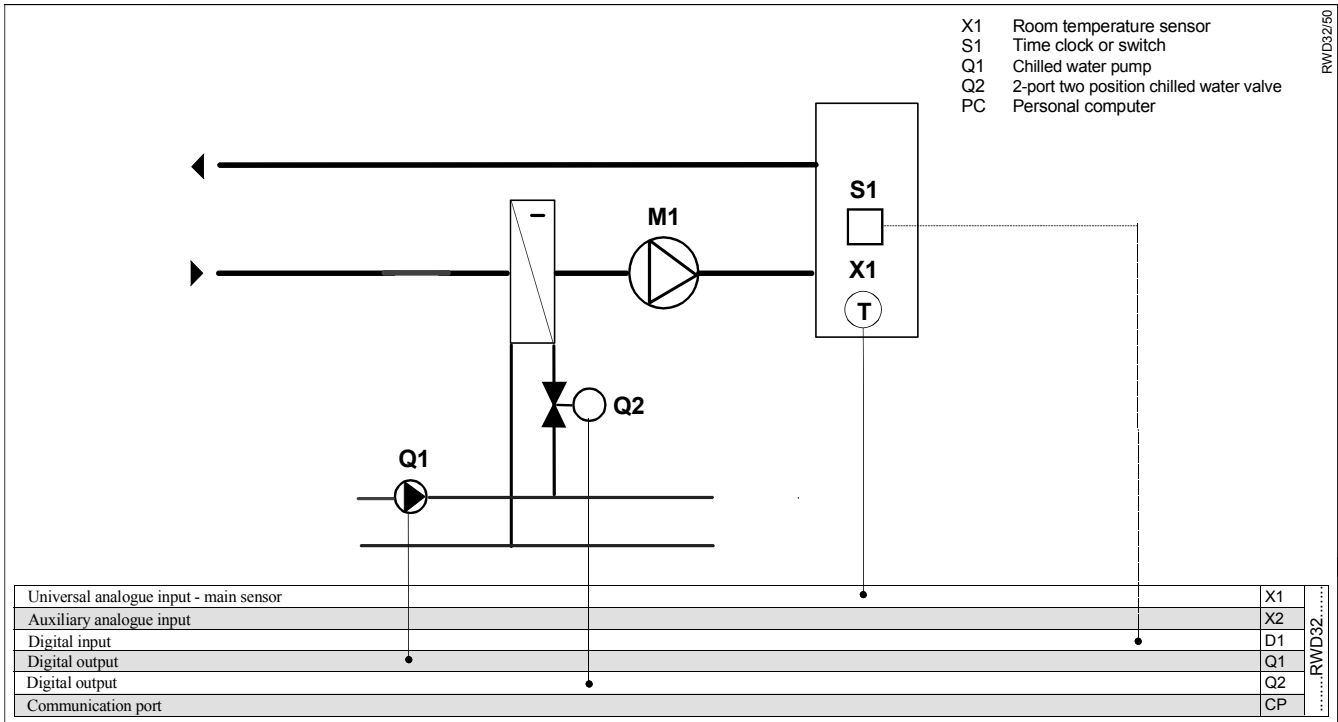

Supplemental features

Control

- Room temperature sensor can be selected as Ni1000, Pt1000, or active sensor.
- Combined adjustable differential of digital outputs Q1 and Q2.
- Adjustable ON position of Q1.
- 230Vac controller supply voltage
- 230Vac two position control valve

Operating modes

- Day / night set points can be selected via time clock or switch.
- Dependent mode for the two cooling outputs, meaning that there is one set point only, one differential adjustment across combined Q1 and Q2, with the ON position of Q1 adjustable.

Description of operation

The temperature sensor senses the room conditions and on a rise in temperature the RWD32 via Q1 digital output energises the chilled water pump. A further rise in temperature Q2 opens the two position chilled water valve. In this application the Q1 – ON position should be set to 5 – 10% of the SD differential setting.

Function diagram

Cooling sequences

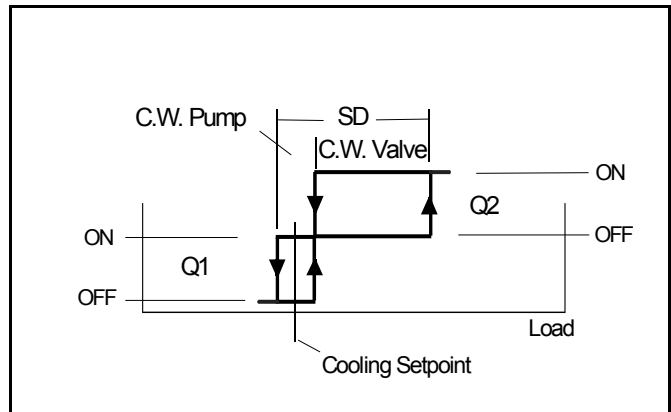

Connection diagram

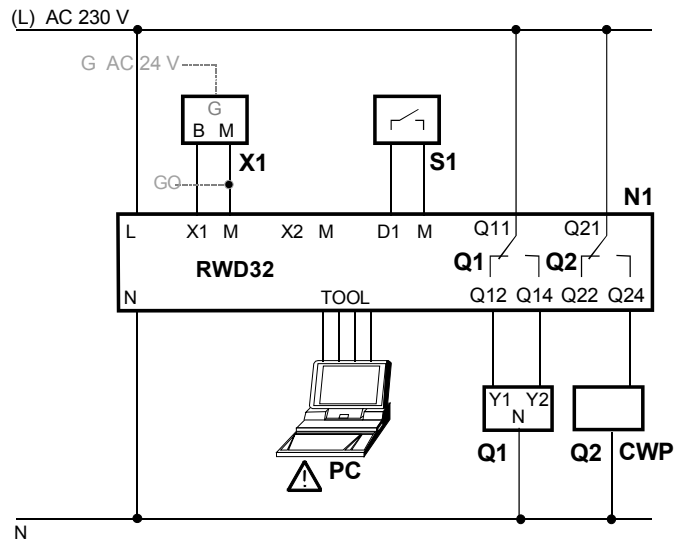





RWD32



- N1 RWD32 controllers
- X1 Main temperature sensor
- S1 Time clock or switch
- Q1 Chilled water pump output
- Q2 230Vac two position valve actuator
- CWP Chilled water pump contactor
- PC Personal computer

Main Display



The main display shows ,

- Whether Q1 is On or Off ( = off,  = on)
- Whether Q2 is On or Off ( = off,  = on)
- Whether day or night set point is selected. (\boxtimes = day, C = night)
- X1 value (room temperature) in ° C.

Other displays are available by pressing the + button, and the various displays are listed below in sequence from the main display.

On entering any of the four set point displays, the setpoint on display can be adjusted by pushing the  enter/save button, increase value by pressing the \blacktriangle + button or decrease the value by pressing the \blacktriangledown - button, and when the required value is reached, press the  enter/save button to save the new value.

The alternative displays return to the main display after 20 seconds duration.

Press buttons	Action	Current display	Selected display	Selected display comments
\blacktriangle	Push + button	Q1 Q2 \boxtimes X1	SP – c \boxtimes 25.0c	cooling day set point.
\blacktriangle	Push + button	SP – c \boxtimes 25.0c	SP – c C 16.0c	cooling night set point.
\blacktriangle	Push + button	SP – c C 16.0c	X1 18.0c	X1 - main temperature sensor reading
\blacktriangle	Push + button	X1 18.0c	Q1 ON	Q1 – chilled water pump digital output, display on or off.
\blacktriangle	Push + button	Q1 ON	Q2 ON	Q2 – chilled water valve digital output, display on or off.
\blacktriangle	Push + button	Q2 ON	 50	Control sequence diagram and application number display.
\blacktriangle	Push + button	 50	Q1 Q2 \boxtimes X1	Back to main display

Values shown are either default values or nominated for information only