

SIEMENS



Flush-mounted room temperature controllers for VAV / CAV applications, with LCD

RDU340

Basic Documentation

Edition: 3.0

CE1P3078en
2014-11-03

Building Technologies

Table of contents

1	About this document	4
1.1	Revision history	4
1.2	Reference documents.....	4
1.3	Before you start	4
1.3.1	Copyright.....	4
1.3.2	Quality assurance	4
2	Summary	5
2.1	Brief description.....	5
2.2	Features	5
2.3	Type summary	5
2.4	Equipment combinations.....	6
2.5	Accessories	7
2.6	Ordering	7
3	Use	7
4	Functions	8
4.1	Temperature control.....	8
4.2	Operating modes	9
4.3	Setpoints	10
4.4	Applications	11
4.5	Additional features.....	12
4.6	Control sequences.....	14
4.6.1	Single duct.....	14
4.6.2	Single duct with electrical heater	16
4.7	Control output.....	17
4.8	Multifunctional input.....	18
4.9	Error handling.....	19
4.10	DIP switches.....	19
4.11	Control parameters	20
5	Handling	23
5.1	Mounting and installation	23
5.2	Operating Instructions.....	24
5.3	Disposal	24
6	Engineering	25
6.1	Connection terminals	25
6.2	Connection diagrams.....	25
7	Mechanical design	26
7.1	Dimensions.....	27
8	Technical data	28

1 About this document

1.1 Revision history

Edition	Date	Changes	Section	Pages
3.0	2014-10-21	Update for RoHS 2.0 and overcurrent protection and other minor changes	5.1 5.3 6.2 8	23 24 25 28
2.0	2014-09-04	Update P51 Mounting and wiring information Date format changed in line with ISO 8601 specifications (yyyy-mm-dd format).		
1.0	2008-07-11	First edition		

1.2 Reference documents

Ref.	Document title	Type of document	Document No.
N3078	Flush-mounted room temperature controllers with LCD	Datasheet	CE1N3078en
B3076	Operating Instructions		CE1B3076en
M3078	Mounting Instructions		CE1M3078xx

1.3 Before you start

1.3.1 Copyright

This document may be duplicated and distributed only with the express permission of Siemens, and may be passed only to authorized persons or companies with the required technical knowledge.

1.3.2 Quality assurance

These documents have been prepared with great care.

- The contents of all documents are checked at regular intervals.
- Any corrections necessary are included in subsequent versions.
- Documents are automatically amended as a consequence of modifications and corrections to the products described.

Please ensure that you are aware of the latest revision date of the documentation. If you find any lack of clarity while using this document, or if you have any criticisms or suggestions, please contact the product manager in your nearest branch office, or write directly to the support team at Headquarters in Zug (see below).

Support address:

Siemens Switzerland Ltd.
Building Technologies Group
International Headquarters
Field Support 5500
Gubelstrasse 22
6301 Zug, Switzerland
Tel. +41 41 724 5500
Fax. +41 41 724 5501
E-mail: fieldsupport-zug.ch.sbt@siemens.com

2 Summary

2.1 Brief description

The devices support VAV heating and cooling systems:

- **Modulating PI / P control**
- **Control depending on the room or the return air temperature**
- **Output for a DC 0..10 V actuator and AC 230V electrical heater (ON-OFF)**
- **Automatic or manual heating/cooling changeover**
- **Operating modes: Comfort, Energy Saving and Protection**
- **Two multifunctional inputs for keycard contact, external sensor, etc.**
- **Adjustable commissioning and control parameters**
- **Minimum and maximum setpoint limitation**
- **Adjustable minimum and maximum limitation of output signal DC 0..10V**
- **Output signal inversion as an option**
- **Mounting on recessed rectangular conduit box, 60.3 mm fixing centers**
- **AC 24 V operating voltage**

2.2 Features















- Maintain room temperature via built-in temperature sensor external room temperature / return air temperature sensor
- Automatic or manual changeover between heating and cooling mode
- Select applications via DIP switches
- Select operating mode via the operating mode button on the controller
- Display current room temperature or setpoint in °C and/or °F
- Minimum and maximum setpoint limitation
- Key lock (automatic and manual)
- Two multifunctional inputs, freely selectable for:
 - Operating mode switchover contact (key card)
 - Automatic heating/cooling changeover sensor
 - External room temperature or return air temperature
 - Dewpoint sensor
 - Electric heater enable
 - Alarm input
- Minimum and maximum limitation of air flow signal DC 0..10V
- Floor heating temperature limit
- Reload factory settings for commissioning and control parameters

2.3 Type summary

Product number	Operating Voltage	Control output			LCD Backlight	Infrared receiver	Housing Colour
		3 pt	on/off	DC 0..10 V			
RDU340	AC 24 V	--	✓	✓			white

2.4 Equipment combinations

DC 0..10 V actuators

Type of unit		Product number	Data sheet
Cable temperature sensor or changeover sensor, cable length 2.5 m NTC (3 k Ω at 25 °C)		QAH11.1	1840
Room temperature sensor NTC (3 k Ω at 25 °C)		QAA32	1747
Electrical actuator, DC 0..10V (for radiator valve)		SSA61...	4893
Electrical actuator, DC 0..10 V (for 2- and 3-port valves / V...P45)		SSC61...	4895
Electrical actuator, DC 0..10V (for small valve 2,5 mm)		SSP61...	4864
Electrical actuator, DC 0..10V (for small valves 5.5 mm)		SSB61...	4891
Electrical actuator, DC 0..10 V (for CombiValves VPI45)		SSD61...	4861
Electromotoric actuator, DC 0..10V (for valves 5.5 mm)		SQS65...	4573
Electrothermal actuator, AC 24 V, NC, DC 0...10 V, 2 m (for radiator valves and small valve 2.5 mm)		STA63	4884
Electrothermal actuator, AC 24 V, NO, DC 0...10 V, 2 m (for radiator valves and small valve 2.5 mm)		STP63	4884
DC 0...10 V damper actuator		GQD161...	4605
		GDB161...	4634
		GLB161...	
		GMA161...	4614
		GEB161...	4621
		GCA161...	4613
		GBB161...	4626
		GIB161...	
VAV compact controller		GDB181.1E/3	3544
		GLB181.1E/3	

*) The documents can be downloaded from <http://siemens.com/bt/download>.

2.5 Accessories

Designation	Product no.	Data Sheet ^{*)}
Changeover mounting kit (50 pcs/package)	ARG86.3	N3009
Plastic mounting spacer for flush mounted thermostats for increasing the headroom in the conduit box by 10 mm	ARG70.3	N3009
Conduit box for flush mounted thermostat	ARG71 / S55770-T137	N3009

*) The documents can be downloaded from <http://siemens.com/bt/download>.

2.6 Ordering

When ordering, indicate both product number and name:

E.g. **RDU340** room temperature controller

Order valve actuators separately.

3 Use

Control of the room temperature in individual rooms of ventilation or air conditioning plants that are:

- Heated or cooled by single duct.
- Heated and cooled by single duct with auxiliary electrical heater.

The RDU340 is suitable for use with VAV systems in connection with the VAV compact controllers types G...B181.1E/3.

The RDU340 controls

- One DC 0...10 V actuator
- One DC 0...10 V actuator and AC 230V 1-stage electrical heater

Use in systems with:

- Heating or cooling mode
- Automatic heating/cooling changeover
- Manual heating/cooling changeover
- Heating and cooling (single duct with electrical heater)

4 Functions

4.1 Temperature control

General note

The setting of the control parameters (P01 etc., mentioned throughout the document) is described in section 4.11.

The controller acquires the room temperature via built-in sensor, external room temperature sensor (QAA32), or external return air temperature sensor (QAH11.1), and maintains the setpoint by issuing actuator control commands to heating and/or cooling equipment. The following control outputs are available:

- Modulating PI / P control with DC 0..10 V control output for actuators and ON-OFF for electrical heater.

The switching differential or proportional band is 2 K for heating mode and 1 K for cooling mode (adjustable via parameters P30 and P31).





The integral action time for continuous PI control is 5 minutes (adjustable via parameter P35).

Display

The display shows the acquired room temperature or the setpoint for the current operating mode, selectable via parameter P06. The factory setting displays the current room temperature.

Use parameter P04 to display the room temperature or setpoint in °F rather than °C as needed.



If the controller is used in a system with manual heating/cooling changeover (P01=2), the heating  and cooling  symbols on the display show the terminal unit status. Thus, the symbols are displayed even when the controller operates in the neutral zone. For all other cases, the heating  and cooling  symbols are displayed when the heating or cooling output is energized.

Concurrent display of °C and °F

Concurrent display of the current temperature or setpoint in °C and in °F (parameter P07) is possible on the controller without weekly time program.

4.2 Operating modes

Select the controller's operating mode via operating mode button  on the controller or operating mode input (e.g. keycard occupancy sensor, when X1 or X2 set to 3 (P38, P40)). A corresponding setpoint is used to maintain the room temperature at the desired level depending on the active operating mode. The following operating modes are available:

Comfort mode

In Comfort mode, the controller maintains the setpoint which can be adjusted via the +/- buttons.

Energy Saving

Energy Saving mode helps save energy. Select it by pressing the operating mode button  if parameter P02 is set accordingly, or if the external operating mode switchover contact is active (e.g. window contact).

Note

If the external operating mode switchover contact is active, user operations are ineffective and "OFF" is displayed. Control will then be according to energy saving setpoints (P11 and P12).

Standby /Protection mode

In Standby mode, the system is

- protected against frost (factory setting **8 °C**, can be disabled or changed via P65).
- protected against overheating (factory setting **OFF**, can be enabled or changed via P66)

4.3 Setpoints

Comfort mode ☼

Setpoint limitation

The setpoint in Comfort mode can be adjusted via the +/- buttons.

For energy saving purposes, the setpoint adjusting range can be limited to minimum (P09) and maximum (P10).

P09 < P10

- If the minimum limit **P09 is set lower** than the maximum limit P10, both heating and cooling are adjustable between these two limits.

P09 ≥ P10

- For heating **or** cooling applications (e.g. single duct)
 - The setting range in cooling mode is from **P09...40°** instead of 5...40°
 - The setting range in heating mode is from **5...P10°** instead of 5...40°
- For cooling and heating with el. heater applications (e.g. single duct)
 - The setting range is from P09...40° instead of 5...40°
 - The setpoint for the el. heater is maximal limited by P10

Examples	Single duct heating or cooling	Single duct cooling with el heater
P09 < P10	<p>5°C 18°C 25°C 40°C P09 P10</p> <p>Cooling setpoint adjustable 18...25°C Heating setpoint adjustable 18...25°C</p>	<p>5°C 18°C 25°C 40°C P09 P10</p> <p>Setpoint adjustable 18...25°C Heating setpoint := Cooling setpoint – dead zone</p>
P09 ≥ P10	<p>5°C 21°C 25°C 40°C P10 P09</p> <p>Cooling settable 25...40°C Heating settable 5...21°C</p>	<p>5°C 21°C 25°C 40°C P10 P09</p> <p>Setpoint adjustable 25...40°C Heating setpoint := Cooling setpoint – dead zone, but max (limited by) P10</p>

Temporary setpoint

If the “Temporary setpoint function” is enabled via parameter P69, the setpoint adjusted via the +/- buttons is set back to the Comfort basic setpoint when the operating mode changes.

The factory setting for the Comfort basic setpoint is **21 °C** and can be changed via parameter P08.

Energy Saving mode ☾

Use control parameters P11 and P12 to adjust the Economy mode setpoints. The heating setpoint is factory-set to **15 °C** and to **30 °C** for cooling.

Standby mode ☹

Use control parameters P65 and P66 to adjust the Standby mode setpoints. The heating setpoint is factory-set to **8 °C** (frost protection) and to **OFF** for cooling.





Caution ⚠

If a setpoint is set to OFF (P65, P66), the controller does not maintain the setpoint in the corresponding mode (heating or cooling).

This means no protective heating or cooling function and thus risk of frost in the heating mode or risk of overheat in cooling mode!

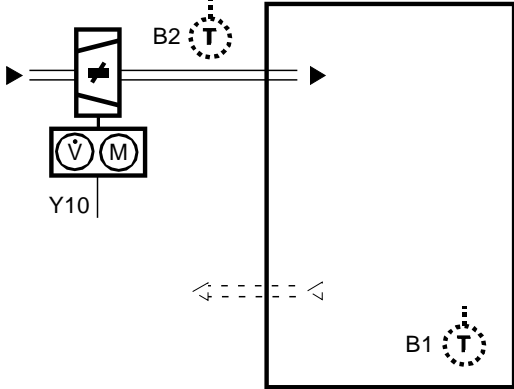
4.4 Applications

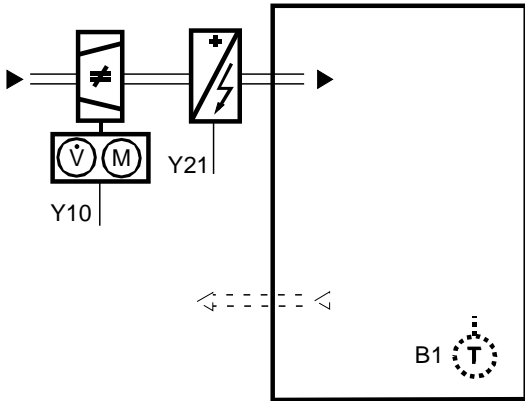
The controller supports following applications, which can be configured by DIP switches on the inner side of the controller front panel.

Application and output signal, DIP switches, diagram	
<p>Single duct, heating or cooling Modulating, DC 0...10 V output signal normal</p>  	<p>Single duct, heating or cooling Modulating, DC 0...10 V output signal inverted</p> 
<p>Single duct with electrical heater, cooling and heating, with auxiliary heater Modulating, DC 0...10 V output signal normal Note: on-off electrical heater</p>  	<p>Single duct with electrical heater, cooling and heating, with auxiliary heater DC 0...10 V output signal inverted Note: on-off electrical heater</p> 

V1 Heating or heating / cooling valve actuator

B1 Return air temperature sensor or external room temperature sensor (optional)

E1 Electric heater

B2 Changeover sensor (optional)

4.5 Additional features

Automatic H/C changeover

The air or water temperature acquired by the changeover sensor (QAH11.1) is used to change over from heating to cooling mode and vice-versa. When the water temperature is above 28 °C (parameter P37), the controller changes over to heating mode, and to cooling mode when below 16 °C (parameter P36). If the water temperature is between the 2 changeover points immediately after power up, the controller starts in heating mode. The water temperature is acquired at 30-second intervals and the operating state is updated accordingly.

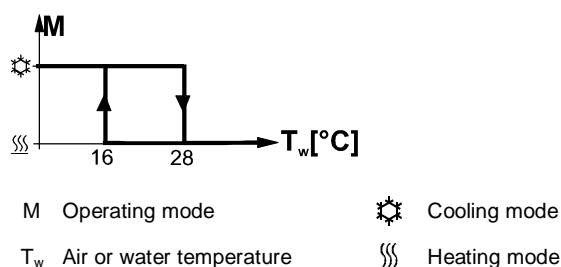

Remote heating/cooling changeover

The QAH11.1 cable temperature sensor for automatic heating/cooling changeover can be replaced by an external switch for manual, remote changeover:

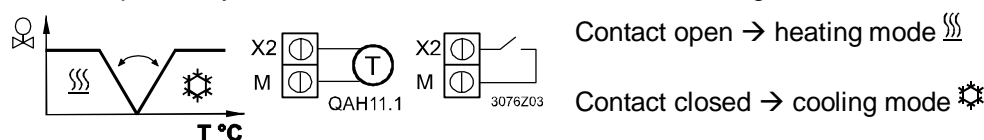

The sensor or switch can be connected to the input terminal of X2 (factory setting) or X1 depending on the commissioning of inputs X1 and X2. See also section “Multifunctional input”.

External/return temperature sensor

The controller acquires the room temperature via built-in sensor, external room temperature sensor (QAA32), or external return air temperature sensor (QAH11.1) connected to multifunctional input X1 or X2.

Inputs X1 or X2 need to be commissioned accordingly. See section 4.8 “Multifunctional input”.

Dewpoint monitoring

Dewpoint monitoring is essential to prevent condensation on the chilled ceiling and help avoid associated damage to the building. This is an optional function and is provided in case the controller is used for a chilled ceiling application.

A dewpoint sensor with a voltage-free contact is connected to multifunctional input X1 or X2. If there is condensation, the cooling valve is fully closed until no more condensation is detected and the cooling output is disabled temporarily. The condensation symbol D is displayed during temporary override.

Input X1 or X2 must be commissioned accordingly. See section “4.8 Multifunctional input”.

Key lock

If the key lock function is enabled by parameter P14, then pressing 7 seconds on the operating mode button M , the keypad will be locked or unlocked respectively. If “Auto lock” is configured, then the controller will automatically lock the keypad after 30 seconds of the last adjustment.

Min / Max air flow

The output signal of the air flow (DC 0..10V) can be limited to a minimum value by using parameter P63 and to a maximum value using parameter P64. These air flow limitation values can be set between 0% and 100%. This is used to ensure a minimum or maximum supply air volume.

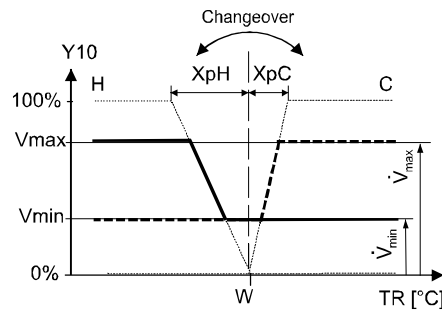

- T Room temperature
- Y10 Control output
- W Room temperature setpoint
- XpH Proportional band Heating
- XpC Proportional band Cooling
- Vmin Minimum limitation air flow
- Vmax Maximum limitation air flow

Output signal inversion

The output signals DC 0...10V can be inverted by means of DIP switch #2.

- If DIP switch #2 is set to “OFF”, 0V corresponds to 0% travel and 10V to 100% (factory setting).
- In position ON, 0V corresponds to 100% travel and 10V to 0% travel.

This function is useful in conjunction with normally open valves.

Floor temperature limitation function

The floor temperature should be limited for 2 reasons: Comfort and protection of the floor.

The floor temperature sensor, connected to multifunctional input X1, acquires the floor temperature. If the floor temperature exceeds the parameterized limit (parameter P51), the heating valve is fully closed until the floor temperature drops to a level 2 K below the parameterized limit.

This function is factory-set to OFF (disabled).

Input X1 or X2 must be commissioned accordingly (P38 = 1).

See section 4.8“Multifunctional input”.

Recommended values for P51:

Living rooms:

Up to 26 °C for long-time presence, up to 28 °C for short-time presence.

Bath rooms:

Up to 28 °C for long-time presence, up to 30 °C for short-time presence.

The table below shows the relation between parameter, temperature source and temperature display:

Parameter P51	External temp. sensor available	Source for display of room temperature	Output control according to	Floor temp. limit. function
OFF	No	Built-in sensor	Built-in sensor	Not active
OFF	Yes	External temp. sensor	External temp. sensor	Not active
10...50 °C	No	Built-in sensor	Built-in sensor	Not active
10...50 °C	Yes	Built-in sensor	Built-in sensor + limit by external sensor	Active

4.6 Control sequences

4.6.1 Single duct

If the selected application is "single duct", then the controller can be used in systems featuring:

- Heating or cooling mode (P01=0 or P01=1).
- Manual heating/cooling changeover (P01=2).
- Automatic heating/cooling changeover (P01=3).

The relevant modes can be adjusted via commissioning parameter "Control sequence" P01, depending on the selected application.

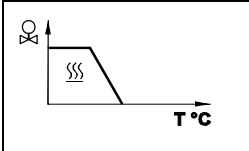
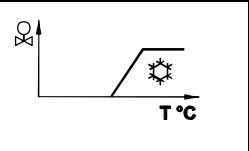
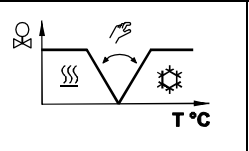
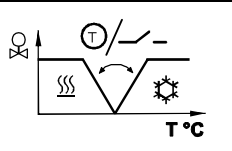
Sequence				
Parameter	P01 = 0	P01 = 1	P01 = 2	P01 = 3
Mode	Heating mode	Cooling mode	Manually select heating or cooling mode	Automatic heating/cooling changeover via external water temperature sensor or remote switch
Available for:				
Single duct	✓	✓	✓	✓

In application "Single duct with el. heater", the controller operates in heating AND cooling mode.

Single duct, heating or cooling

In single duct applications, the controller controls an actuator (valve, damper, VAV system, etc)

- in heating/cooling mode with changeover (automatic or manual),
- heating only mode,
- or cooling only mode.

Cooling only is factory set (P01=1).

The output can be limited to a minimum and maximum value if required. See section 4.5 "additional features".

Control sequence modulating output

The diagram below shows the control sequence for continuous PI control.

Heating only mode

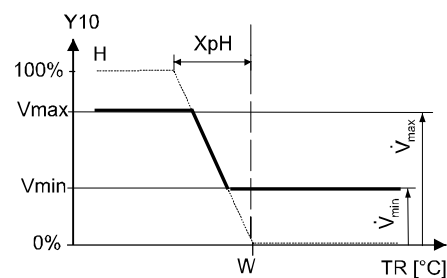

Cooling only mode

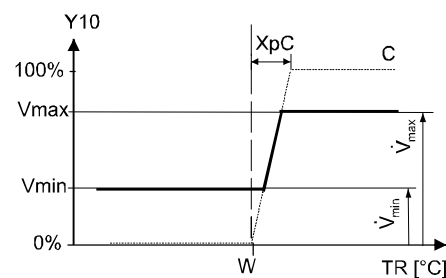

Changeover

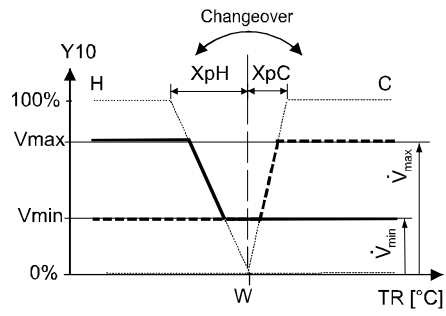

- T[°C] Room temperature
- w Room temperature setpoint
- Y10 Control command "Valve"
- XpH Proportional band "Heating"
- XpC Proportional band "Cooling"
- Vmin Min. limitation for output
- Vmax Max. limitation for output

Note

The diagrams show the PI controller's proportional part only

4.6.2 Single duct with electrical heater

If the selected application is "single duct & el. heater", then the controller works in heating and cooling mode.

The output can be limited to a minimum and maximum value if required.
See section 4.5 "additional features".

Single duct with el. heater

In single duct applications with electrical heater, the controller controls an actuator (valve, damper, VAV system, etc.) plus an auxiliary electrical heater.

Note: The setpoint for the electrical heater is limited by parameter "Maximum heating setpoint" (P10).

Digital input "Enable electrical heater"

Remote enabling/disabling of the electrical heater is possible via digital input X1/X2 for tariff regulations, energy saving etc.
Input X1 or X2 must be commissioned accordingly. See section "4.9 Multifunctional input".

Control sequence

The diagram below shows the control sequence for continuous PI control.

Cooling and heating with electric heater

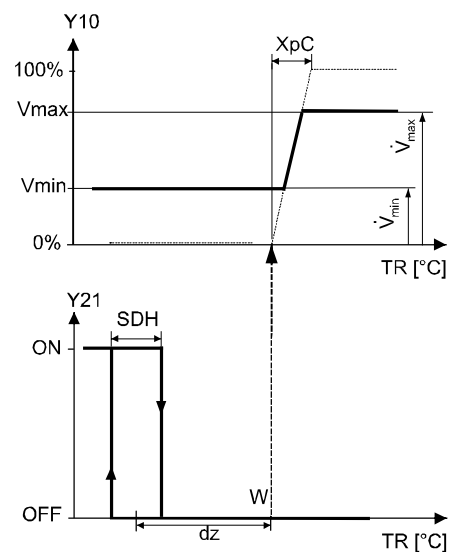

TR[°C] Room temperature

W Room temperature setpoint

Y10 Control command "actuator"

Y21 Control command "electrical heater"

Vmin Min. limitation for output

Vmax Max. limitation for output

XpC Proportional band "Cooling"

Xdz Dead zone

SDH Switching differential

Note: The diagrams show the PI controller's proportional part only.

4.7 Control output

Overview of control output

Different control output signals are available depending on the controller type.

Control output	on/off	3-position	DC 0...10 V
Type reference			
RDU340	Y21 (1)	--	Y10 (1)

() Number of outputs

DC 0...10 V control signal

The demand calculated by the PI control from the current room temperature and setpoint is provided to the valve actuator as a continuous DC 0...10 V signal via output Y10.

Electrical heater control signal (2-position)

The electrical heater receives an **ON** command via the auxiliary heating control output Y21:

1. When the acquired room temperature is below "setpoint for electric heater".
2. When the electrical heater has been switched off for more than 1 minute.

The **OFF** command for the electrical heater is output:

1. When the acquired room temperature is above the setpoint (electric heater).
2. When the electrical heater has been switched on for more than 1 minute.

 Caution

A safety thermostat (to prevent overheating) must be provided externally.

4.8 Multifunctional input

The controller offers two multifunctional inputs X1 and X2. A sensor of type NTC like QAH11.1 (AI) or a switch (DI) can be connected to the input terminals. The functionality of both inputs can be configured via parameters P38 for input X1 and P40 for input X2.

#	Function of input X1/X2	Description	Type
0	Not used	No function.	-
1	External/Return air temp.	Sensor input external room temperature sensor or return air temperature sensor to measure the current room temperature.	AI
2	Heat/cool changeover	Sensor input for automatic heating/cooling changeover function. A switch can also be connected rather than a sensor.	AI/(DI)
3	Operating mode switchover	Digital input to switch over the operating mode to Energy Saving. If the operating mode switchover contact is active, user operations are ineffective and "OFF" is displayed.	DI
4	Dewpoint monitor	Digital input for a dewpoint sensor to detect condensation. Cooling is stopped if condensation occurs.	DI
5	Enable electrical heater	Digital input to enable/disable the electrical heater via remote control.	DI
6	Alarm	Digital input to signal an alarm. If the input is active, "ALx" (x=1 or 2) is displayed. Note: Alarm displays do not influence controller operations. They merely represent a visual signal. <i>Example:</i> No air flow or el. heater overheated.	DI

Operational action can be changed between normally open (N.O.) and normally closed (N.C.) via parameter P39 or P41 if it is a digital input (DI).

Each function can only be assigned to input X1 or X2; only "Alarm" can be assigned to both inputs.

X1 is factory-set to "Operating mode switchover" (3) and X2 to "Heating/cooling changeover" (2).

For more information see section 4.4 "Applications".

4.9 Error handling

Temperature out of range

When the room temperature is outside the measuring range, i.e. above 49 °C or below 0 °C, the limiting temperatures flash, e.g. "0 °C" or "49 °C".

If the temperature is below 0 °C and the controller is in heating mode and the current setpoint is not set to "OFF", then the control output Y10 or Y21 respectively will issue actuator control commands to heating equipment.

For all other cases, the control output is de-energized. The controller resumes Comfort mode after the temperature returns to within the measuring range.

4.10 DIP switches



Use the DIP switches on the inner side of the front panel to commission the basic controller applications prior to snapping it to the base.

DIP switch number	1	2
Application		
Single duct (factory setting)	OFF	n.a.
Single duct & electrical heater	ON	n.a.
DC 0...10 V output signal normal (factory setting)	n.a.	OFF
DC 0...10 V output signal inverted (see section 4.5)	n.a.	ON

Note: During startup, the controller reloads the control parameter factory settings after each DIP switch settings change.

4.11 Control parameters

A number of control parameters can be readjusted to optimize control performance. These parameters can also be set during operation without opening the unit. In the event of a power failure, all control parameter settings are retained.

The control parameters are divided in two levels:

- “Service” level, and
- “Expert” level.

The “Service” level contains a small set of parameters to set up the controller for the HVAC system and to adjust the user interface. These parameters can usually be adjusted any time.

Change parameters in the “Expert” level only carefully, as they impact control performance and functionality of the controller.

Parameter setting

Enter only “Service” level

Change the parameters as follows:

1. Set the controller to Standby (⏻ *)
2. Press buttons + and - simultaneously for 3 seconds. Release and press button + again for 3 seconds within 2 seconds. The display shows “P01”. Continue at Step 3.

Enter “Service” and “Expert” level.

1. Set the controller to Standby (⏻ *)
2. Press buttons + and - simultaneously for 3 seconds. Release and press button - again for 6 seconds within 2 seconds. The display shows “P01” and service.

Adjust parameters

3. Select the required parameter by repeatedly pressing buttons + and -.
4. When you press buttons + and - simultaneously, the current value of the selected parameter starts to flash, which can be changed by repeatedly pressing buttons + or -.
5. When you again press buttons + and - simultaneously, the next parameter is displayed.
6. Repeat Steps 3 to 5 to display and change additional parameters.
7. All changes are saved and the controller returns to Standby 10 seconds after the last display or setting.

Reset parameters

The factory setting for the control parameters can be reloaded via parameter P71, by changing the value to “ON”, and confirming by pressing buttons + and - simultaneously. The display shows “8888” during reload.

Note

*) If one of the digital inputs is commissioned as window contact, and the contact is closed, the controller will switch to ECO mode and parameter setting will not be possible. Solution: open the window contact.

Control parameters

#	Parameter	Factory setting	Setting range	RDU340
Service Level				
P01	Control sequence (for application "single duct" only)	1 (Cooling only)	0:= Heating only 1:= Cooling only 2:= Manual H/C 3:= Auto changeover	✓
P02	Mode selection via user operating mode button	1 (Stb, Comf)	1 = Stb, Comf 2 = Stb, Comf, Eco	✓
P04	Selection of °C or °F	°C	(0) °C (1) °F	✓
P05	Sensor calibration	0.0 K	- 3 ... +3 K	✓
P06	Standard temperature display	0 (Room temp)	0:= Room temperature 1:= Setpoint	✓
P07	Additional user info	0 (no display)	0:= no display 1:= Temp in °C and °F	✓
P08	Comfort basic setpoint	21 °C	5 ... 40 °C	✓
P09	Minimum setpoint limitation for Comfort (WminComf)	5 °C	5 ... 40 °C	✓
P10	Maximum setpoint limitation for Comfort (WmaxComf)	35 °C	5 ... 40 °C	✓
P11	Heating setpoint for Energy Saving (WheatEco)	15 °C	OFF, 5 °C...WcoolEco	✓
P12	Cooling setpoint for Energy Saving (WcoolEco)	30 °C	OFF, WheatEco...40 °C	✓
P14	Key lock (Press the operating mode button  for 7 seconds to enable or disable the key lock)	0 (Unlocked)	0:= Unlocked 1:= Auto lock 2:= Manual lock	✓

Note

- P01 is not available when the controller is commissioned as single duct with el. heater (DIP switch #1 = ON)
- P02 is not available when the controller is commissioned for manual heating/cooling changeover (P01=2)
- Parameter display depends on selected application and function

(x) Not available

#	Parameter	Factory setting	Setting range	RDU340
Expert Level				
P30	P-band/switching differential for heating mode	2K	0.5 ... 6 K	✓
P31	P-band/switching differential for cooling mode	1 K	0.5 ... 6 K	✓
P33	Dead zone in Comfort mode	2 K	0.5 ... 5 K	✓
P35	Integral time	5 min	0...10 min	✓
P36	Heating/cooling changeover switching point for cooling	16 °C	10...25 °C	✓
P37	Heating/cooling changeover switching point for heating	28 °C	27...40 °C	✓
P38	X1 functionality	3 (Op mode switchover)	0:= NA 1:= Ext/Return air temp 2:= Heat/cool changeover 3:= Operating mode switch 4:= Dewpoint monitor 5:= Enable electrical heater 6:= Alarm input	✓
P39	Operating action for X1 if digital input	0 (N.O.)	0:= Normally open 1:= Normally closed	✓
P40	X2 functionality	2 (H/C c/o)	Same as P38	✓
P41	Operating action for X2 if digital input	0 (N.O.)	0:= Normally open 1:= Normally closed	✓
P51	Flow temp limit floor heating	OFF	OFF, 10...50 °C	✓
P58	"no function"	ON		✓
P63	Minimum output limitation air flow signal (0..10V)	0%	0...100%	✓
P64	Maximum output limitation air flow signal (0..10V)	100%	0...100%	✓
P65	Heating setpoint for Standby \odot (Wheat _{Stb})	8 °C	OFF, 5 °C...Wcool _{Stb}	✓
P66	Cooling setpoint for Standby \odot (Wcool _{Stb})	OFF	OFF, Wheat _{Stb} ...40 °C	✓
P69	Temporary setpoint for Comfort mode	OFF	OFF:= Disabled ON := Enable	✓
P71	Parameter reset Set value to ON and confirm by pressing the + and – buttons	OFF	OFF:= Idle ON: = Reset	✓
Diagnostic & Test				
d01	Application	Diagnose	2P:= single duct 2PEL:= single duct & el. heater	✓
d02	Status input X1	Diagnose	0:= Digital input not activated 1:= Digital input activated 0...49 °C = measured temp. value 00 := H/C input short 100:= H/C input open	✓
d03	Status input X2	Diagnose	Same as d02	✓

5 Handling

5.1 Mounting and installation

Mount the room controller on a recessed rectangular conduit box with 60.3mm fixing centers. Do not mount on a wall in niches or bookshelves, behind curtains, above or near heat sources, or exposed to direct solar radiation. Mount about 1.5 m above the floor.

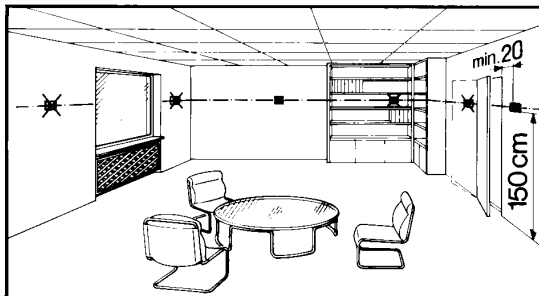

Mounting



- Devices must be mounted on clean, dry indoor place and not be exposed to dripping or splashing

Wiring



- See the mounting instructions M3078 enclosed with the controller.
- Comply with local regulations to wire, protection and earth the thermostat.
 - The power supply line must have a circuit breaker with a rated current of no more than 10 A. For US installations use Class 2 rated power supplies.



Warning!

No internal line protection for supply lines to external consumers (Y10, Y21)

Risk of fire and injury due to short-circuits!

- Adapt the line diameters as per local regulations to the rated value of the installed overcurrent protection device.
- Isolate the cables of SELV inputs X1-M/X2-M if the conduit box carries AC 230 V mains voltage.
- Inputs X1-M or X2-M of different units (e.g. summer/winter switch) may be connected in parallel with an external switch. Consider overall maximum contact sensing current for switch rating.
- No metal conduits
- No cables provided with a metal shield
- Disconnect from supply before opening the cover.



Commissioning

Set the controller application via the DIP switches before snapping the front panel on the mounting base.

After power is applied, the controller carries out a reset during which all LCD segments flash indicating that the reset was correct. After the reset, which takes about 3 seconds, the controller is ready for commissioning by qualified HVAC staff. The control parameters of the controller can be set to ensure optimum performance of the entire system (see “Set control parameters”).

Control sequence

- The control sequence may need to be set via parameter P01 depending on the application. The factory setting for the single duct application is “Cooling only”.

Calibrate sensor

- Recalibrate the temperature sensor if the room temperature displayed on the controller does not match the room temperature measured. To do this, change parameter P05.

Setpoint and range limitation

- We recommend to review the setpoints and setpoint ranges (parameters P08...P12) and change them as needed to achieve maximum comfort and save energy.

5.2 Operating Instructions

See the operating instructions B3076 enclosed with the controller.

5.3 Disposal



The devices are considered electronics devices for disposal in term of European Directive 2012/19/EU and may not be disposed of as domestic waste.

- Dispose of the device via the channels provided for this purpose
- Comply with all local and currently applicable laws and regulations.

6 Engineering

6.1 Connection terminals

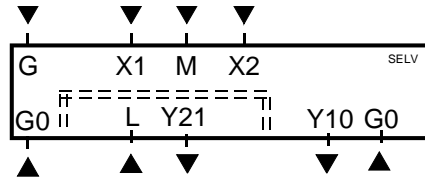

- G, G0 Operating voltage controller AC 24 V
- L Operating voltage for electrical heater AC 230 V
- Y21 Control output for electrical heater
- Y10 Control output for DC 0...10 V actuator
- X1, X2 Multifunctional input for temperature sensor (e.g. QAH11.1) or switch
- M Measuring neutral for sensor and switch

6.2 Connection diagrams

Application:

Single duct in VAV/CAV

Heating or cooling for universal or AHU

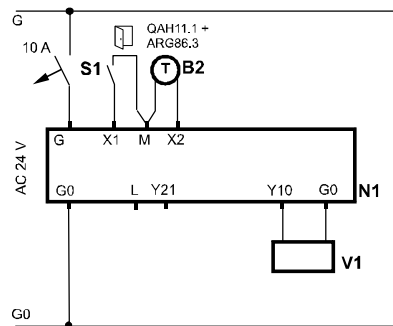

G - G0 AC 24 V



For US installations, use Class 2 rated power supplies.
For other installations, use circuit breakers with rated current of no more than 10 A.

- N1 Room temperature controller RDU340...
- V1 DC 0...10V actuator for heating or cooling
- S1 Operating mode switch-over contact (e.g. key card)
- B2 Heat/cool changeover sensor

Application:

Single duct with electrical heater in VAV/CAV

Heating and cooling with electric heater for universal or AHU

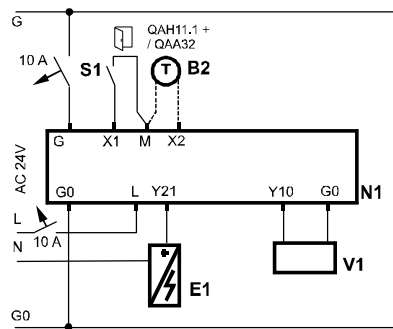

G - G0, Y10 AC 24 V
L - N, Y21 AC 230 V



For US installations, use Class 2 rated power supplies.
For other installations, use circuit breakers with rated current of no more than 10 A.

- N1 Room temperature controller RDU340...
- V1 DC 0...10V actuator for heating or cooling
- E1 Electrical heater
- S1 Operating mode switch-over contact (e.g. key card)
- B2 Heat/cool changeover sensor

7 Mechanical design

The controller consists of 2 parts:

- Front panel accommodating the electronics, operating elements and built-in room temperature sensor.
- Mounting base with the power electronics.

The rear of the mounting base contains the screw terminals. The base fits on a rectangular conduit box with 60.3 mm fixing centers. Slide the front panel in the mounting base and snap on.

Operation and settings

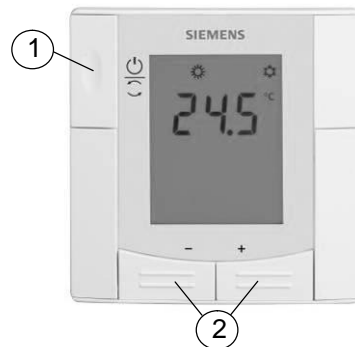

1. Operating mode selector/Standby
2. Adjust setpoint and control parameters

Display

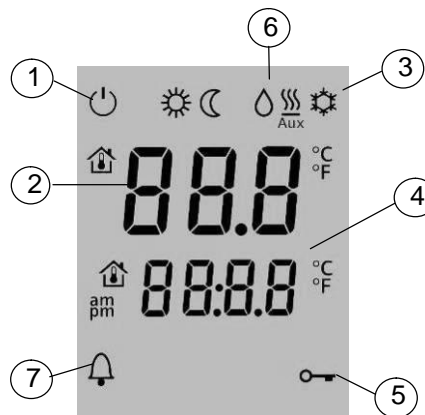

1. Operating mode
 - ⏻ Standby / protected mode
 - ☀ Comfort mode
 - 🌙 Energy Saving mode
2. Display room temperature, setpoints and control parameters.
 - 🏠 Symbol used to display the current room temperature
3. Heating/cooling mode
 - ⚙ Cooling mode
 - ☀ Heating mode,
 - ☀ Aux Electrical heater active
4. Additional user information
5. Key lock active
6. Condensation in room (dewpoint sensor active)
7. Indicate alarm or reminder

7.1 Dimensions

Dimensions in mm

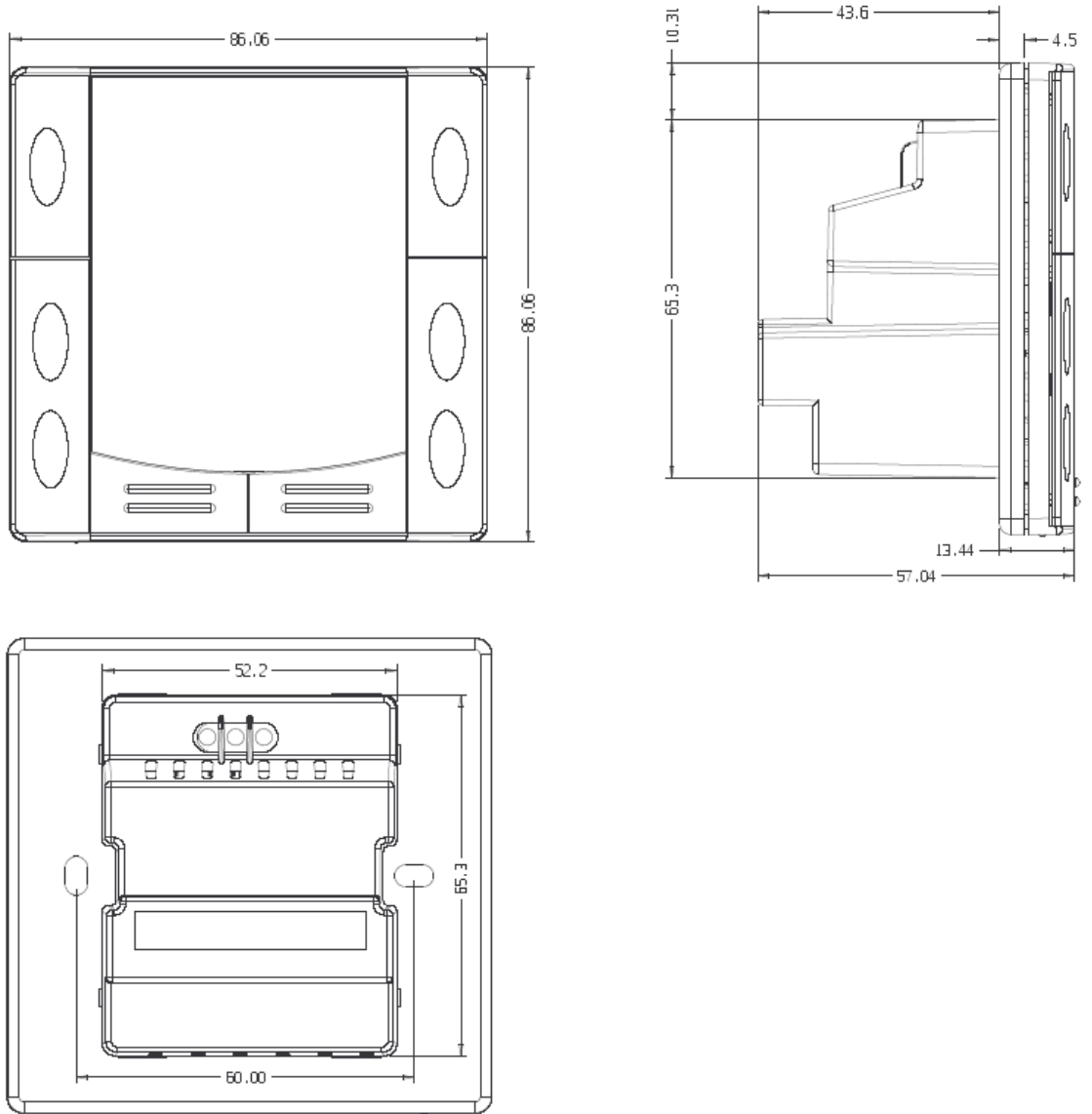

8 Technical data

⚠ Power supply	Operating voltage	SELV AC 24 V \pm 20 % or AC 24 V class 2 (UL)	
	Frequency	50/60 Hz	
	Power consumption	Max. 8 VA	
	External supply line protection (EU)	Circuit breaker max. 10 A Characteristic B, C, D according to EN 60898 or Power source with current limitation of max. 10 A	
⚠ Warning	No internal fuse External preliminary protection with max. C 10 A circuit breaker required in all cases		
	Outputs	Control output Y10-G0	SELV DC 0...10 V
		Resolution	39 mV
		Current	Max. \pm 1 mA
		Control output Y21-L (N.O.)	AC 230 V
		Rating	5 mA...5(2) A
⚠ Warning	No internal fuse External preliminary protection with max. C 10 A circuit breaker in the supply line required under all circumstances		
	Inputs	Multifunctional input X1-M/X2-M	
Temperature sensor input: Type		Operating	NTC (3 k Ω at 25 °C)
Digital input: action			Selectable (N.O./N.C.)
Contact sensing			SELV DC 0...5 V/max 5 mA
Insulation against mains voltage (SELV)			4 kV, reinforced insulation
Function input: External temperature sensor, heating/cooling changeover sensor, operating mode switchover contact, dewpoint monitor contact, enable electrical heater contact, alarm contact			Selectable
Operational data	Switching differential, adjustable		
	Heating mode	(P30)	2 K (0.5...6K)
	Cooling mode	(P31)	1 K (0.5...6K)
	Setpoint setting and range		
	☀ Comfort mode	(P08)	21°C (5...40 °C)
	⌚ Energy Saving mode	(P11-P12)	15°C/30°C (OFF, 5...40 °C)
	⏻ Standby	(P65-P66)	8°C/OFF (OFF, 5...40 °C)
	Multifunctional input X1/X2	Selectable 0...6	
	Input X1	3: (P38) operating mode switchover	
	Input X2	2: (P40) heating/cooling changeover sensor	
Multifunctional input X1/X2	Selectable 0...6		
Input X1	Factory setting = 3 (P38)	Operating mode switchover	
Input X2	Factory setting = 2 (P40)	Heat/cool changeover sensor	

	Built-in room temperature sensor	
	Measuring range	0...49 °C
	Accuracy at 25 °C	< ± 0.5 K
	Temperature calibration range	± 3.0 K
Environmental conditions	Settings and display resolution	
	Setpoints	0.5 °C
	Current temperature value displayed	0.5 °C
	Operation	As per IEC 721-3-3
	Climatic conditions	Class 3K5
	Temperature	0...+50 °C
	Humidity	<95 % r.h.
	Transport	As per IEC 721-3-2
	Climatic conditions	Class 2K3
	Temperature	-25...+60 °C
	Humidity	<95 % r.h.
	Mechanical conditions	Class 2M2
Standards	Storage	As per IEC 721-3-1
	Climatic conditions	Class 1K3
	Temperature	-25...+60 °C
	Humidity	<95 % r.h.
	EU Conformity (CE)	CE1T3076_1 ^{*)}
	RCM Conformity	CE1T3076_1en_C1 ^{*)}
	Protective class	II as per EN 60730-1
	Pollution class	Normal
	Degree of protection of housing	IP 30 to EN 60529
	The product environmental declarations CE1E3076_1 ^{*)} contain data on environmentally compatible product design and assessments (RoHS compliance, materials composition, packaging, environmental benefit, disposal).	
General	Connection terminals	Solid wires or prepared stranded wires 1 x 0.4...2.5 mm ² or 2 x 0.4...1.5 mm ²
	Housing front color	RAL 9003 white
	Weight	0.220 kg

*) The documents can be downloaded from <http://siemens.com/bt/download>.

Index

A		
Alarm.....	18	
Automatic H/C changeover	12	
Automatic heating/cooling changeover	14	
C		
Calibrate sensor.....	23	
Comfort mode.....	9	
Commissioning	23	
Control output.....	5	
Control parameters	20	
Cooling mode	14	
D		
DC 0..10 V control signal	17	
Dewpoint	18	
Digital input.....	18	
DIP switches.....	19	
E		
Electrical heater	11, 16	
Enable electrical heater.....	16	
Enable/disable the electrical heater.....	18	
Energy Saving	9	
Expert level parameters	20	
External/Return air temp.	18	
External/return temperature sensor	12	
F		
Floor temperature limitation function	13	
H		
Heat/cool changeover	18	
Heating mode	14	
Housing color.....	5	
I		
Integral action time	8	
K		
Key lock	12	
M		
Manually select heating or cooling mode	14	
Min / Max air flow	12	
Modulating output.....	14	
Mounting and installation	23	
Multifunctional inputs	18	
O		
On/off control output signals	17	
Operating mode button.....	9	
Operating mode input.....	9	
Operating mode switchover	18	
Operating voltage.....	5	
Output signal inversion.....	13	
P		
Parameter setting.....	20	
Proportional band.....	8	
R		
Remote heating/	12	
Reset parameters.....	20	
S		
Sensor input.....	18	
Service level.....	20	
Setpoint and range limitation	24	
Setpoint limitation	10	
Single duct	11	
Standby /Protection mode.....	9	
Switching differential.....	8	
T		
Temperature out of range	19	
Temporary setpoint.....	10	

Siemens Switzerland Ltd.
Building Technologies Division
International Headquarters
Gubelstrasse 22
CH-6301 Zug
Tel. +41 41-724 24 24
Fax +41 41-724 35 22
www.siemens.com/sbt

© 2008 (-2014) Siemens Switzerland Ltd.
Subject to change