



Heating Controller

RVL480

Multifunctional and communicating heating controller for use in residential and non-residential buildings. Suited for heating circuit control, boiler temperature control or precontrol. Suited for heat source systems like burners or district heat. 6 preprogrammed plant types. Operating voltage AC 230 V

Use

- Types of buildings:
 - Multi-family houses
 - Single-family houses
 - Non-residential buildings
- Types of plants:
 - Heating zones equipped with their own boilers
 - Heating zones with district heat connection
 - Combined plants consisting of heat generation and several heating zones
- Types of heating systems:
 - Radiator, convector, underfloor and ceiling heating systems, radiating panels

Functions





Heating zone control

- Weather-dependent flow temperature control through control of the valve in a heating zone
- Weather-dependent flow temperature control through control of the burner in a heating zone
- Weather-dependent flow temperature control through control of the valve in the primary return of a heating zone with district heat connection (transfer station)

Pre-control

- Load-dependent control of the main flow temperature through control of the valve in the main flow; demand for heat via data bus
- Load-dependent control of the boiler temperature through control of the burner; demand for heat via data bus
- Load-dependent control of the secondary flow temperature through control of the valve in the primary return of a district heat connection; demand for heat via data bus

Operating modes

- Auto  **Automatic mode**
Automatic changeover from NORMAL to REDUCED temperature, and vice versa, according to the weekly program, automatic changeover to holiday mode, demand-dependent control of heating system (ECO function)
-  **Setback mode**
Continuous heating to the REDUCED temperature, with ECO function
-  **Comfort mode**
Continuous heating to the NORMAL temperature, no ECO function
-  **Protection**
-  **Manual operation**
No control, circulating pumps in service

Frost protection is ensured in all operating modes.

Other functions

- Optimization functions
- Protective functions
- Remote control
- Commissioning aids
- Communication functions

Ordering

When ordering, please give type reference **RVL480**.

The controller is supplied complete with Operating Instructions and Installation Instructions.

Sensors and, if required, room unit, actuator and valve must be ordered as separate items.

Product documentation

<i>Type of documentation</i>	<i>Document no.</i>	<i>Part no.</i>
Basic Documentation	P2540	–
Installation Instructions (languages: de, en, fr, nl, sv, fi, da, it, es)	G2540	74 319 0617 0
Operating Instructions (languages: de, en, fr, nl, sv, fi, da, it, es)	B2540	74 319 0616 0
CE Declaration of Conformity	T2540	–
Environmental Declaration	E2540	–

Equipment combinations

Suitable sensors and room units

- Flow and return temperature: all sensors with sensing elements LG-Ni 1000, for example:
 - Strap-on temperature sensor QAD22
 - Immersion temperature sensors QAE212... and QAP21.3
- Room temperature:
 - Room unit QAW50
 - Room unit QAW70
 - Room temperature sensor QAA24

- Outside temperature:
 - Outside sensor QAC22 (LG-Ni 1000 sensing element)
 - Outside sensor QAC32 (NTC 575 sensing element)

Suitable actuators

All electromotoric and electrohydraulic actuators for 3-position control made by Siemens.

Communication

The controller is capable of communicating with:

- All units with LPB capability made by Siemens
- SYNERGYR OZW30 central unit (from software version 3.0)

Note

The heating controller RVL480 **cannot** be used as partner unit for the RVL469!

Technical design

Plant types

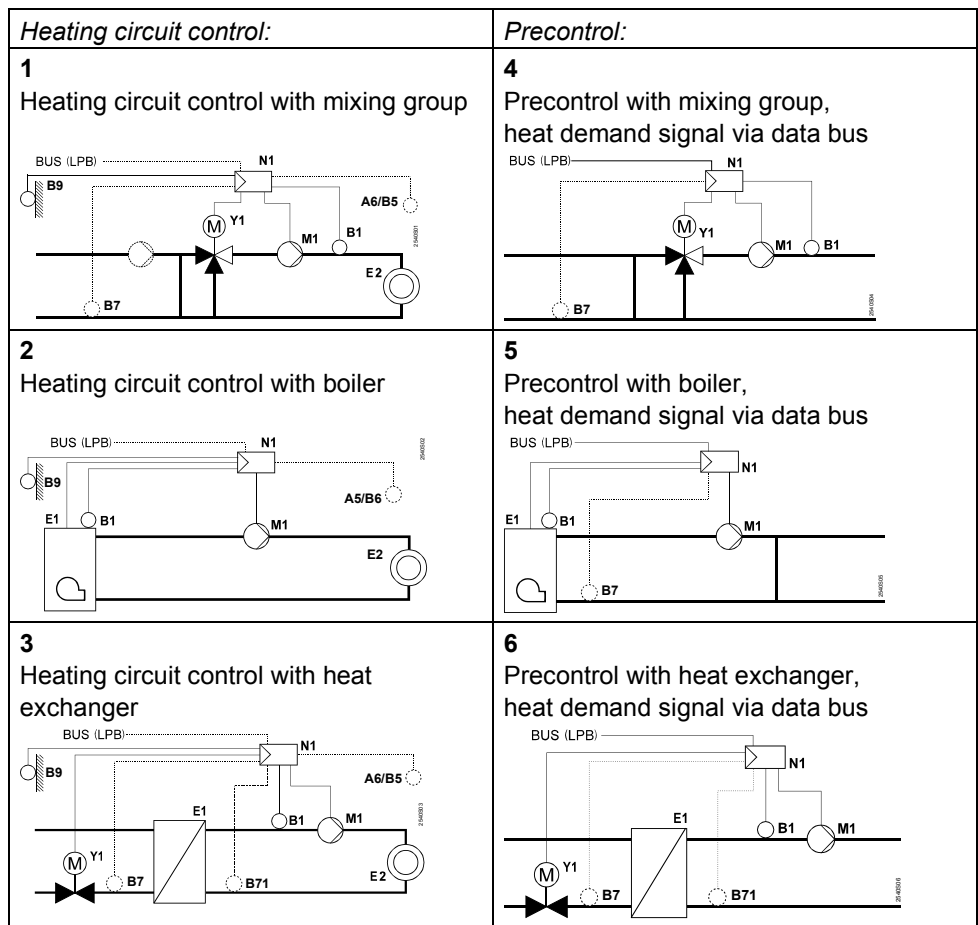

- | | | | |
|-----|-----------------------------------|-----|---|
| A6 | Room unit | E1 | Boiler or heat exchanger |
| B1 | Flow or boiler sensor | E2 | Load (space) |
| B5 | Room sensor | LPB | Data bus |
| B7 | Return sensor (primary circuit) | M1 | Circulating pump or boiler pump |
| B71 | Return sensor (secondary circuit) | N1 | Controller RVL480 |
| B9 | Outside sensor | Y1 | Heating circuit mixing valve / 2-port valve |

Working principle

The RVL480 offers 6 different plant types that are ready programmed in the controller. When commissioning the system, the respective plant type must be entered. This activates all functions that are required for the configured plant type. The standard settings are practice-oriented.

All functions not required for the selected plant type will not be shown and are disabled.

Enduser settings	<p>With weather-dependent control, the flow temperature is controlled in function of the prevailing outside temperature via the heating curve. Its basic setting is made with the little bar on the front of the unit or on an operating line. The room temperature can be readjusted with the knob.</p> <p>In addition, following can be entered by the enduser:</p> <ul style="list-style-type: none"> • Room temperature set values for NORMAL heating, REDUCED heating and frost protection/holidays • Weekly switching program and a maximum of eight holiday periods per year • Operating mode • Time of day and date
Temperature acquisition	<ul style="list-style-type: none"> • Flow temperature: with LG-Ni1000 sensor • Outside temperature: with LG-Ni1000 or NTC 575 sensor; the RVL480 identifies the type of sensor used. With interlinked controllers, it is also possible to define the source of the outside temperature • Room temperature: with a room temperature sensor or a room unit or both (averaging)
Space heating	<ul style="list-style-type: none"> • The room temperature is included in the control. It can be acquired with a sensor or simulated by a room model with an adjustable building time constant. When using a sensor, the effect on the control can be adjusted. It is also possible to limit the maximum room temperature • The heating is switched on and off depending on demand (ECO function). It is switched off when the amount of heat stored by the building mass is sufficient to maintain the required room temperature. In that case, the controller takes into account the development of the room temperature and the building's heat storage capacity. It is possible to set two heating limits, one for NORMAL heating and one for REDUCED heating • The control is optimized. Switching on, heating up and shutting down are controlled such that, during occupancy times, the required room temperature is always maintained. At the end of each occupancy period, the heating will be shut down (circulating pump) until the room temperature set value for the non-occupancy time is reached (quick setback, can be disabled). During heating up, the room temperature set value can be boosted (boost heating). It is possible to set maximum limits for the heating up time and for early shutdown
3-position control	<p>3-position control operates as weather-dependent or load-dependent flow temperature control. P-band and integral action time are adjustable. The flow temperature is controlled via the regulating unit (control or slipper valve). Minimum and maximum limitation of the flow temperature as well as maximum limitation of the rate of set value rise are adjustable.</p>
2-position control	<p>2-position control operates as weather-dependent or load-dependent boiler temperature control. The boiler temperature is controlled through cycling of the single- or 2-stage burner (direct burner control). 2-stage operation is enabled when the release limit is reached, and disabled when the reset limit is reached. The limits can be adjusted. When there is no demand for heat, the boiler will either be shut down or maintained at the minimum temperature limit (selectable). Both minimum and maximum limitation of the boiler temperature are adjustable.</p>

District heat	<p>The secondary flow temperature is controlled via the valve in the primary return, either weather- or load-dependent.</p> <p>Maximum limitations act on the:</p> <ul style="list-style-type: none"> • primary return temperature, whereby the following selections can be made: type of compensation (local outside sensor or bus signal), slope of limit curve, and start of compensation • difference of primary return and secondary return temperature (DRT) <p>Minimum stroke limitation (Y_{\min} function) prevents measuring errors in connection with heat metering when flow rates fall below a certain level.</p> <p>The integral action time of the limit functions is adjustable.</p>
Minimum limitation of return temperature	<p>Minimum limitation of the return temperature acts with both 3-position control and load-dependent control of the boiler temperature and helps prevent flue gas condensation.</p>
Locking functions	<p>On the software side, all settings can be locked to prevent unauthorized readjustments. The district heat settings can be locked on the hardware side.</p>
Time switch	<ul style="list-style-type: none"> • The RVL480 has one weekly time switch for entering the daily occupancy times. Each day can accommodate 3 occupancy times, whereby each weekday may have different occupancy times • For entering a maximum of eight holiday periods, the RVL480 is equipped with a yearly time switch featuring automatic summer- / wintertime changeover
Remote control	<ul style="list-style-type: none"> • Changeover of operating mode with the QAW50 room unit • Overriding the major controller functions with the QAW70 room unit • Selection of another (programmable) operating mode with an external switch • Preselection of a fixed flow temperature set value with an external switch. Type of set value (fixed or minimum) and flow temperature can be selected
Note on QAW70	<p>The day of the week is set automatically with the date by the controller; an adjustment from the room unit QAW70 is not possible.</p>
Passing on the heat demand signal	<p>The heat demand signal can be passed on via the scalable DC 0...10 V output (corresponding to 0...x °C). The value of "x" can be adjusted in the range of 30...130 °C.</p>
Communication	<p>Communication with other devices is effected via the data bus and allows:</p> <ul style="list-style-type: none"> • Signaling of heat demand to the heat generator • Exchange of locking and enforced signals • Exchange of measured values such as outside temperature, return temperature, flow temperature and of clock signals • Reception of heat demand from the SYNERGYR OZW30 central unit (from software version 3.0) • Exchange of error messages
Error messages and flow temperature alarm	<ul style="list-style-type: none"> • Error message in the event of sensor, data bus or room unit faults • Flow temperature alarm; adjustable is a period of time during which the flow temperature may stay outside the set limits; an error message is given when the time has elapsed
Other functions	<ul style="list-style-type: none"> • Display of parameters, actual values, operational statuses and error messages • Simulation of outside temperature • Relay test; all relays can be controlled manually • Sensor test; all measured values of the sensors can be displayed • Testing the contacts connected to terminals H1–M, H2–M, H3–M and H4–M • Outside temperature-dependent frost protection for the plant; a minimum flow temperature is maintained, its set value and the response threshold can be adjusted • Pump overrun time to prevent buildup of heat • Periodic pump run (pump kick) to prevent seizing of the pump in the summer • Controller hours run meter

For more detailed information on communication with LPB, refer to the following documents:

- Data sheet Basic System Data LPB: N2030
- Data sheet LPB: N2032

Mechanical design

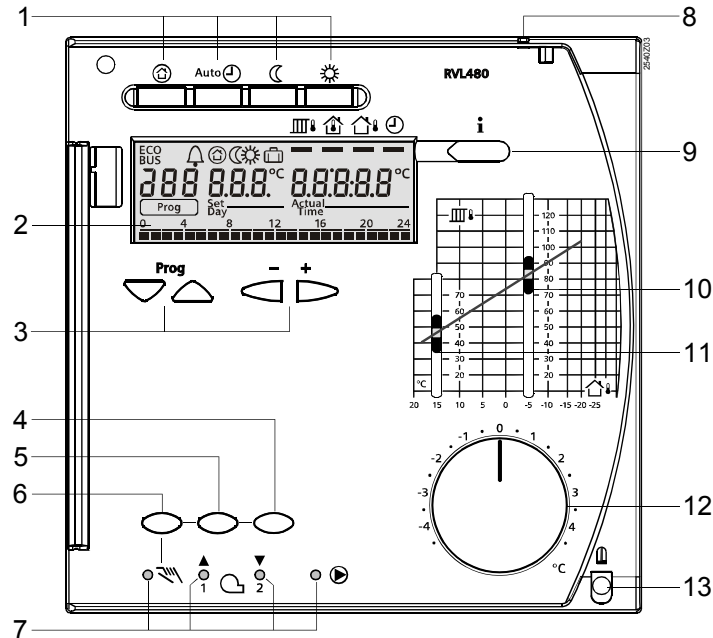

- 1 Operating mode buttons (selected button is lit)
- 2 Display (LCD)
- 3 Buttons for operating the display:
Prog = selection of operating line
- + = adjustment of displayed value
- 4 Button for "Close heating circuit mixing valve" or burner stage 2 ON/OFF in manual operation
- 5 Button for "Open heating circuit mixing valve" in manual operation
- 6 Button for manual operation
- 7 LEDs for:
 - ☐ Manual operation
 - ☐ / ▲ Heating circuit mixing valve opens / burner stage 1 ON
 - ☐ / ▼ Heating circuit mixing valve closes / burner stage 2 ON
 - Pump runs
- 8 Sealing facility in the cover
- 9 Info button for the display of actual values
- 10 Setting slider for flow temperature setpoint at an outside temperature of -5°C
- 11 Setting slider for flow temperature setpoint at an outside temperature of 15°C
- 12 Setting knob for readjustment of room temperature
- 13 Fixing screw with sealing facility

The RVL480 is comprised of controller insert, which accommodates the electronics, the power section, the output relays and – on the front – all operating elements, and the base, which carries the connection terminals. The operating elements are located behind a lockable transparent cover.

The operating instructions can be inserted in the transparent cover.

All values are read in the display (LCD) featuring background lighting.

The controller insert is secured to the base with two screws, one of which can be sealed. The cover can also be sealed.

The RVL480 can be fitted in 3 different ways:

- Wall mounting (on a wall, in the control panel, etc.)
- Rail mounting (on a top hat rail)
- Flush panel mounting (control panel door, etc.)

Analog operating elements

- Buttons for selecting the required operating mode
- Info button
- Direct adjustment of the heating curve with the help of the SIGMAGYR setting facility
- Knob for manual readjustment of the room temperature
- 3 buttons for manual operation and manual positioning commands

Digital operating elements

The entry or readjustment of all setting parameters, activation of optional functions and reading of actual values and statuses is made according to the operating line principle. An operating line with an associated number is assigned to each parameter, each actual value and each function that can be selected. One pair of buttons is used to select an operating line and one pair to readjust the display.

Notes

Engineering

- The wires of the measuring circuits carry extra low voltage, those to the actuator and the pump carry AC 24...230 V
- The local electrical regulations must be complied with
- Sensor cables must not be run parallel to mains carrying cables for loads such as actuator, pump, burner, etc. (insulation class II EN 60730)

Commissioning

- The plant type must be selected
- When used in district heat plants, the district heat parameters can be locked

Disposal



The devices are considered electronics devices for disposal in terms of European Directive 2012/19/EU and may not be disposed of as domestic garbage.

- Dispose of the devices through channels provided for this purpose.
- Comply with all local and currently applicable laws and regulations.

Warranty

When using the RVL480 together with third-party devices not specifically mentioned, correct functioning must be ensured by the user. In that case, Siemens will assume no responsibility for service and warranty.

Technical Data

Power supply	Rated operating voltage	AC 230 V ($\pm 10\%$)	
	Frequency	50 Hz	
	Power consumption (no external load)	max. 7 VA	
	External supply line protection	Slow-blow fuse max. 10 A or Circuit breaker max. 13 A Characteristic B, C, D according to EN 60898	
Output relays	Switching capacity	AC 24...230 V	
	Switching current Y1/K4, Y2/K5, Q1	AC 0.02...2 (2) A	
	Rated current of ignition transformer	max. 1 A (max. 30 s)	
	Switch-on current of ignition transformer	max. 10 A (max. 10 ms)	
	External supply line protection	See section power supply	
Permissible cable lengths to sensors and room unit	Copper cable 0.6 mm \varnothing	20 m	
	Copper cable 0.5 mm ²	50 m	
	Copper cable 1.0 mm ²	80 m	
	Copper cable 1.5 mm ²	120 m	
Connection terminals	Screw terminals for wire section	up to 2.5 mm ²	
Communication by wire	Bus protocol / type	LPB	
	Bus loading characteristic E	6	
Backup	Backup of controller clock	12 h	
Standards, directives and approvals	Product standard	EN 60730-1	Automatic electrical controls for household and similar use
	Electromagnetic compatibility (Applications)		For use in residential, commerce, light-industrial and industrial environments
	EU conformity (CE)		CE1T2540xx *)
	RCM-conformity (EMC)		CE1T2464en_C1 *)
	EAC conformity		Eurasia conformity
Environmental compatibility	Product environmental declaration (contains data on RoHS compliance, materials composition, packaging, environmental benefit, disposal)	CE1E2540 *)	
Eco design and labeling directives		Class	Efficiency gain
	Application with one room temperature sensor and one outdoor temperature sensor and on/off control	VII	3.5%
	Application with one room temperature sensor and on/off control	III	1.5%
	*) The documents can be downloaded from http://siemens.com/bt/download .		
Protective data	Safety class	II to EN 60730	
	Degree of protection (cover closed)	IP42 to EN 60529	
	Degree of contamination	2 to EN 60730	

Dimensions	refer to "Dimensions"			
Weight	Unit (net)	1.1 kg		
Colors	Controller insert	Light grey RAL 7035		
	Terminal base	Pigeon blue RAL 5014		
Ambient conditions		<i>Operation</i>	<i>Transport</i>	<i>Storage</i>
		<i>EN 60721-3-3</i>	<i>EN 60721-3-2</i>	<i>EN 60721-3-1</i>
	Climatic conditions	class 3K5	class 2K3	class 1K3
	Temperature	0...+50 °C	-25...+70 °C	-20...+65 °C
	Humidity	<95 % r.h. (non-condensing)	<95 % r.h.	<95 % r.h. (non-condensing)
	Mechanical conditions	class 3M2	class 2M2	class 1M2
	Use above sea level	max. 3000 m above sea level		

Connection diagrams

Low voltage

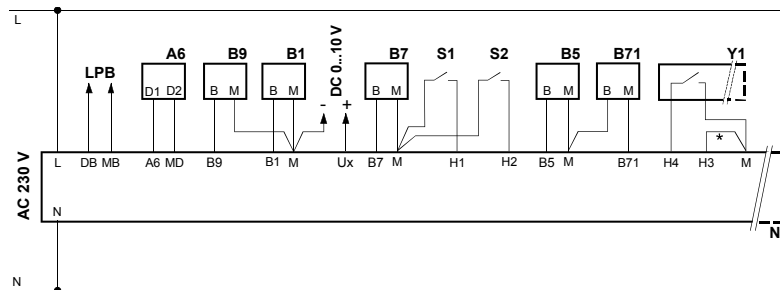

Mains voltage

Left: Connections for plant types 1, 3, 4 and 6 (valve or district heat)

Right: Connections for plant types 2 and 5 (boiler with a 2-stage burner)

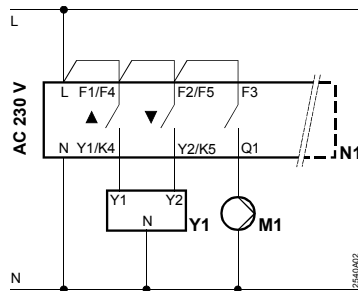

- A6 Room unit
- B1 Flow or boiler sensor
- B5 Room sensor
- B7 Return sensor (primary circuit)
- B71 Return sensor (secondary circuit)
- B9 Outside sensor
- E1 2-stage burner
- F1 Thermal reset limit thermostat
- F2 Manual reset safety limit thermostat

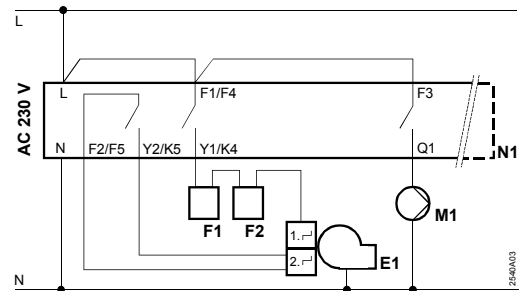

- LPB Data bus
- M1 Heating circuit or boiler pump
- N1 Controller RVL480
- S1 Remote control operating mode
- S2 Remote control flow temperature setpoint
- Ux Heat demand output
- Y1 Actuator of heating circuit with contact for minimum stroke limitation
- * Wire link for locking the district heat parameters

Dimensions

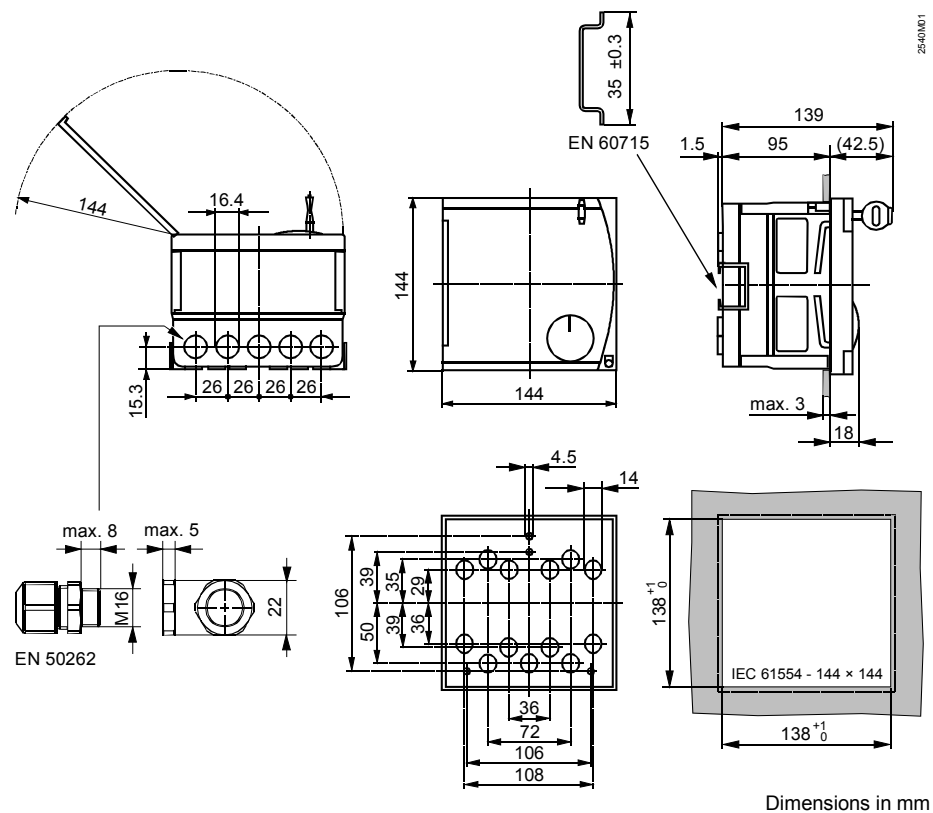

Published by:
 Siemens Switzerland Ltd.
 Building Technologies Division
 International Headquarters
 Gubelstrasse 22
 6301 Zug
 Switzerland
 Tel. +41 41-724 24 24
www.siemens.com/buildingtechnologies

© Siemens Switzerland Ltd 2008
 Delivery and technical specifications subject to change